

Upholstered Storage Bench

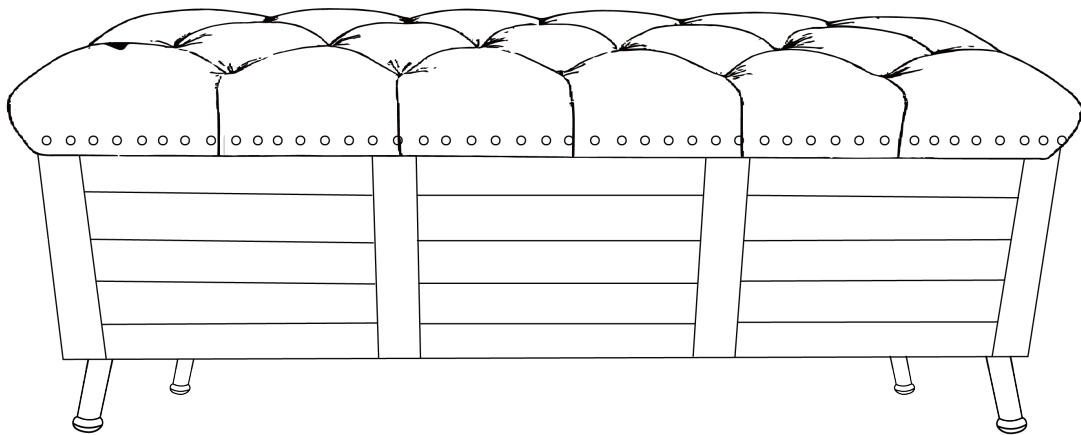

ASSEMBLY INSTRUCTIONS



20 min. assembly

2 person

*The estimated assembly time may vary depending on the individual.

Hey, there

Now is assembly time!

Deeeeeeep breathe.... and again....
Tools ready,
Easy peasy!

Estimated



20 min. assembly
2 person

Tools Required

- Allen Wrench (included)

important: *Cautious when you use power tools*

Thank you for purchasing this product. This product has been manufactured with the highest standards of safety and quality.

PLEASE READ ALL INSTRUCTIONS CAREFULLY BEFORE ASSEMBLY.

Unpack all parts from the packaging inside the carton to ensure there are no missing or damaged parts. Lay out all the parts on a clean, flat, and soft surface to prevent scratches. Refer to the steps provided as assembling guide.

Do not attempt to assemble or use the product if any parts are missing or damaged.

REMINDERS

SAFE USAGE IS KEY

Your well-being is our top priority when you use our product. Please prioritize your safety by diligently following the assembly guidelines and inspecting the product carefully both when it arrives and before each use.

Please be aware that cannot be held liable for any injuries or fatalities that occur due to not adhering to the provided instructions or misuse of the product.

DO NOT MODIFY

Our products undergo rigorous testing to ensure they meet established safety standards before being released for sale. Altering the product in any way can lead to serious safety concerns, for which cannot assume responsibility.

What's in the box

Parts

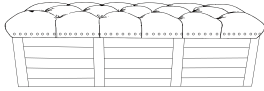

A X 1
Bench

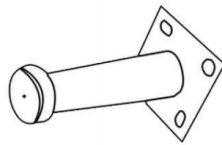

B X 4
metal leg

Hardware & Accessory



1 X 12
M6 x14mm



2 X 12

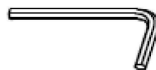

3 X 1

Assembly

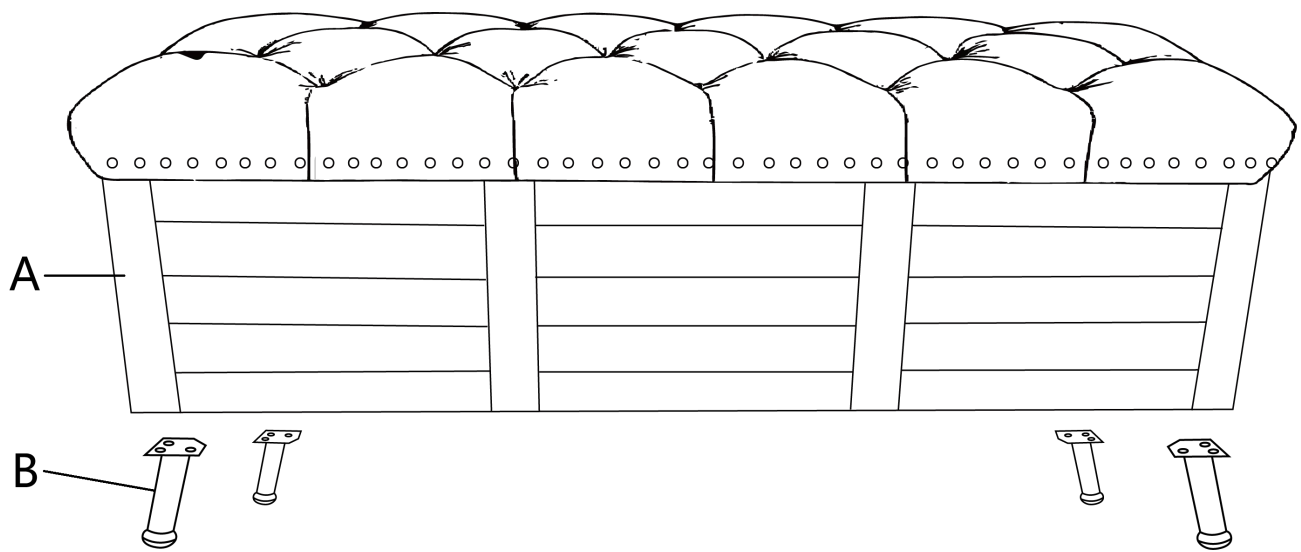

Step 1

Assemble legs B with hardware 1 & 2 and tighten with allen wrench 3.

①X12	②X12	③X1
		
M6x14mm		

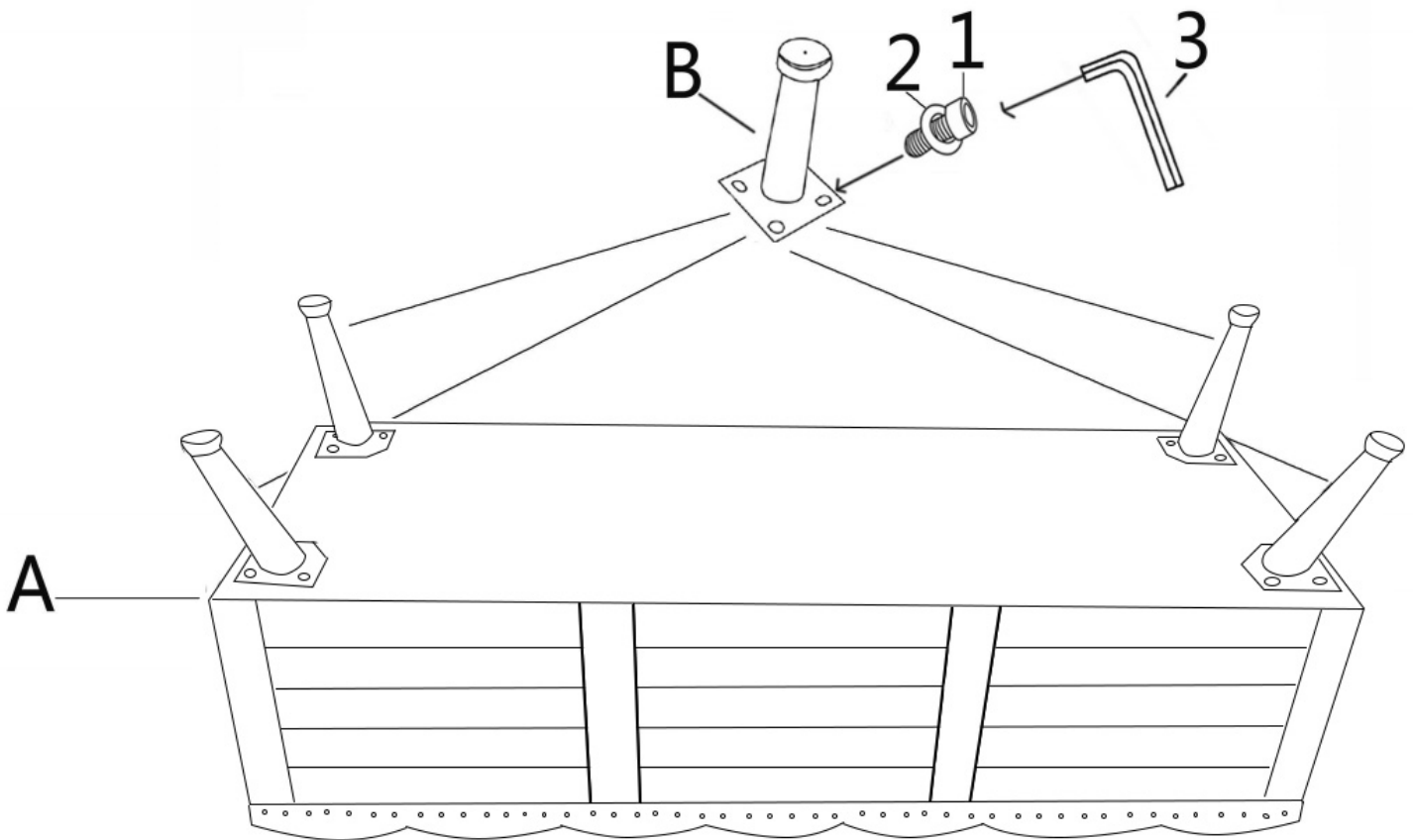

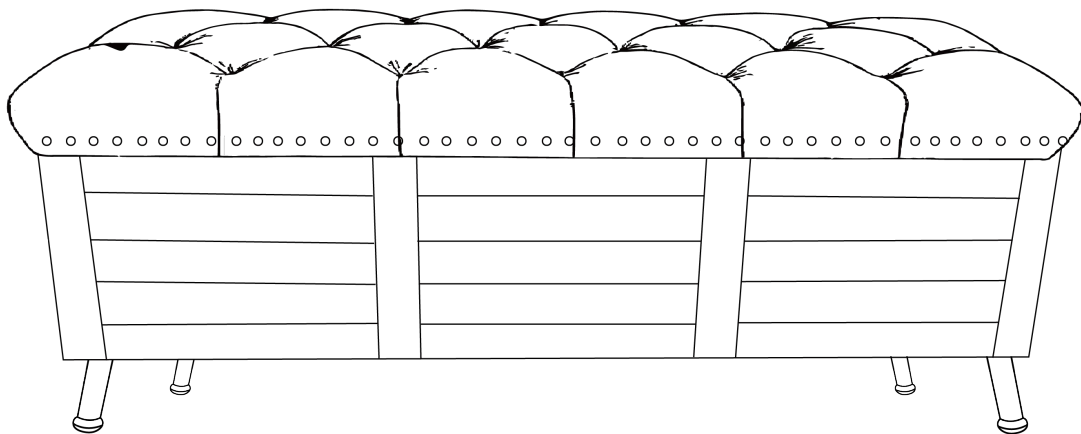

Warning

DO NOT stand on the bench as this may damage the product and cause serious bodily injury.

Something not right?

We are always here to help.

We make mistakes like every human does.

Though we always strive to provide the best possible products at competitive prices and the best service in the industry, it's not possible to completely eliminate mistakes. If you experience any dissatisfaction, feel free to contact us immediately. Our in-house customer care team will respond ASAP.

Things to do to expedite the process

- Have your order# ready
- Take photos/videos to help us better identify the issues
- DO NOT throw away the packaging

Happy with our product?

Leave us a review

It really help us as a small business

- Find the product you purchased on our website (tip: search by SKU) and leave us a review.
- Alternatively, you can always return to the marketplace where you purchased it and leave a review there.

Share with others

Our customers look for REAL stuff

**Please save this manual
for future reference.**