

Assembly Instructions

Caution: You must read this before you proceed.

BENCH

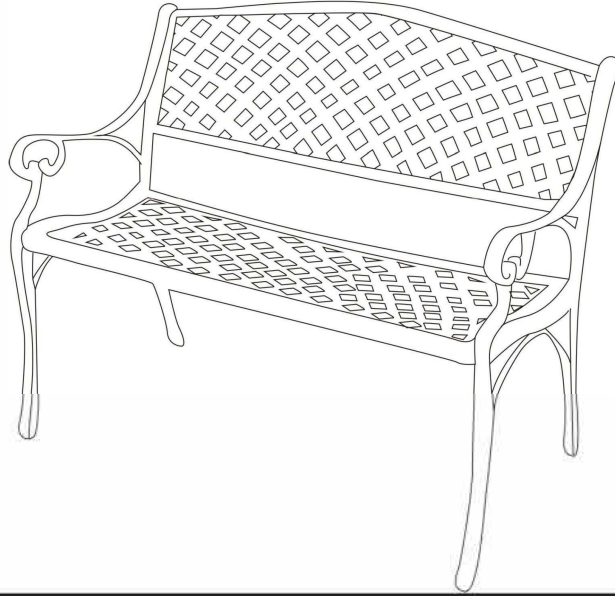





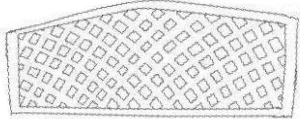
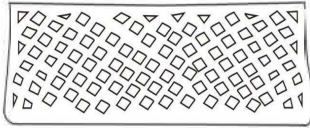
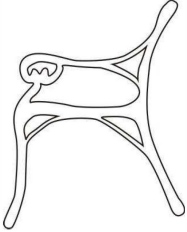
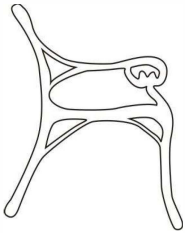

**CAUTION : This bench is NOT a TOY.
Keep your child / children at bay in the process of assembly.**

Parts list

No.	Picture	Description	Qty
A		Backrest Panel	1
B		Chair Seat Panel	1
C		Left Legs Panel	1
D		Right Legs Panel	1

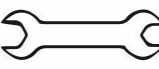



Hardware

No.	Picture	Description	Qty
①		Bolts(M8*20mm)	5
②		Bolts (M8*35mm)	5
		Washers(8mm)	5
		Spring Washers(8mm)	5
		Nuts(8mm)	5
③		Spanner	1
④		Screwdriver	1

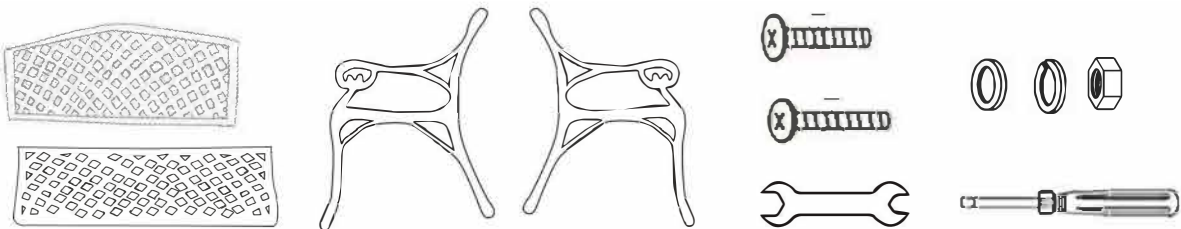
Assembly Preparation

Before Beginning Assembly:



-  • Read instructions, cover to cover-
-  • Have 2 adults on hand for assembly-
-  • Do not assemble on flooring or carpet-
-  • Assemble on a clean non-marring surface (packing foam)-
-  • Save all packaging until finished-

Assembly Step

Overview

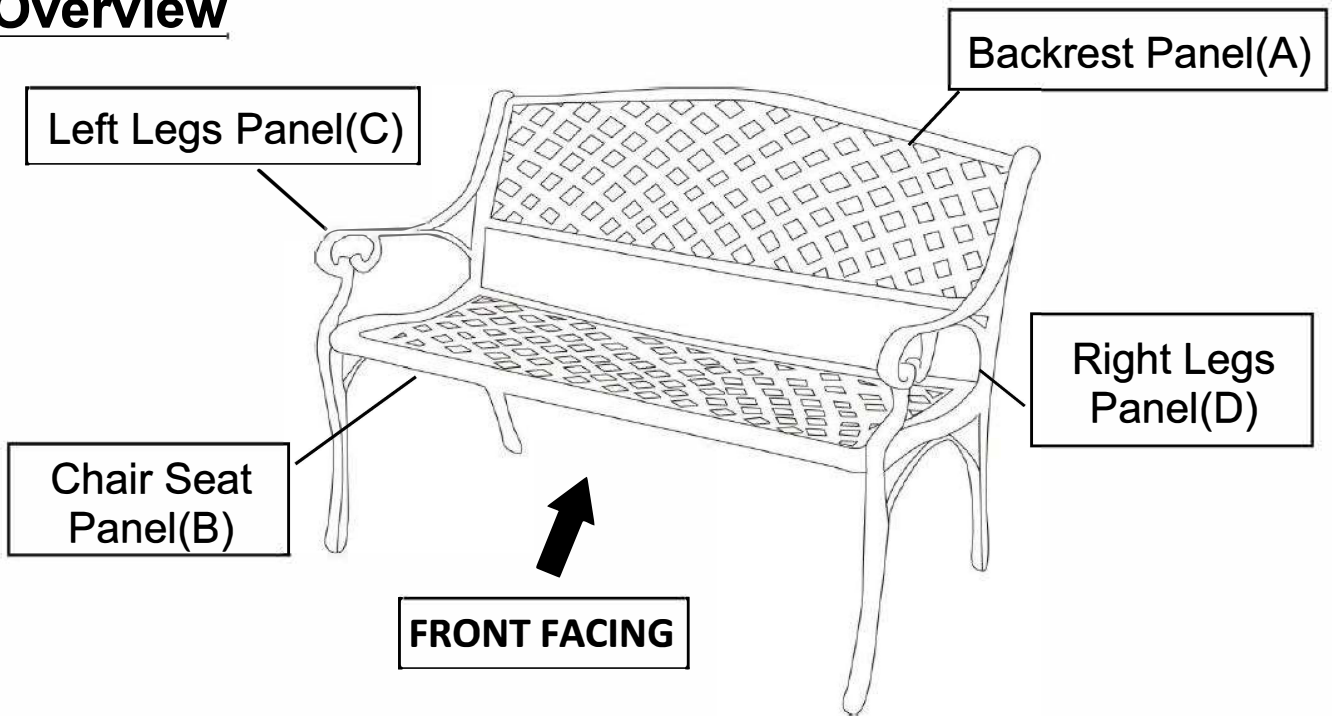

This Bench has multiple parts and may require up to some 30 minutes to assemble.

To give you an overview of the Bench parts, the above picture is to help you put the various parts into perspective.

Please read through the instructions below to familiarise yourself with the parts and steps before assembly.

Step 1

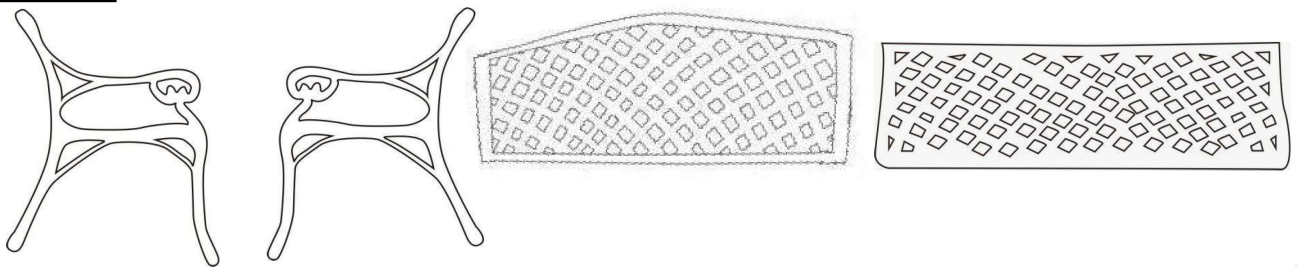

Unpack and place all parts on a clean soft surface.

Step 2

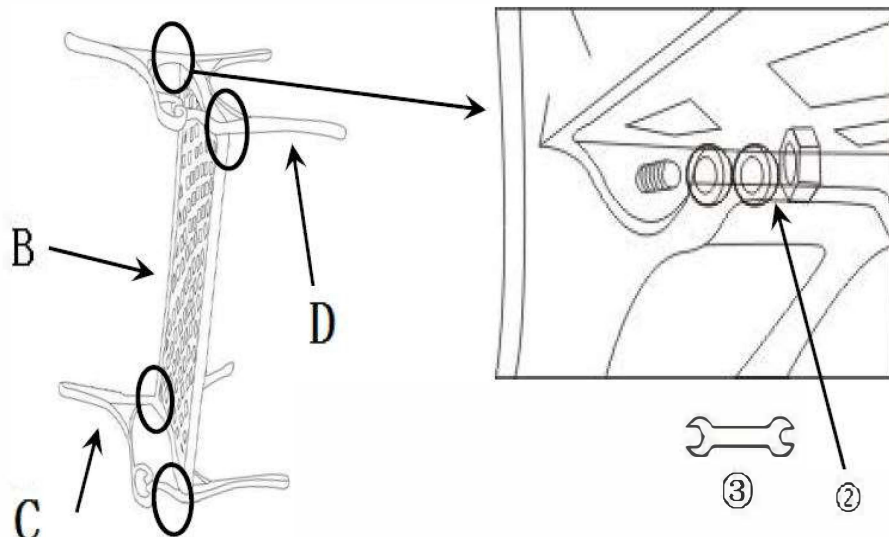

Place the Left Arm(C) on the floor and then slot in the seat panel.
Attach Chair Seat Panel(B) to the Left Legs Panel(C) with Bolts,Washers, Spring Washers and Nuts(②) using Spanner(③).

DO NOT over tighten at this stage.

Then turn and have the Left Arm upwards.

Repeat the same steps to attach Chair Seat Panel(B) to the Right Legs Panel(D).
DO NOT OVERTIGHTEN, yet.

Step 3

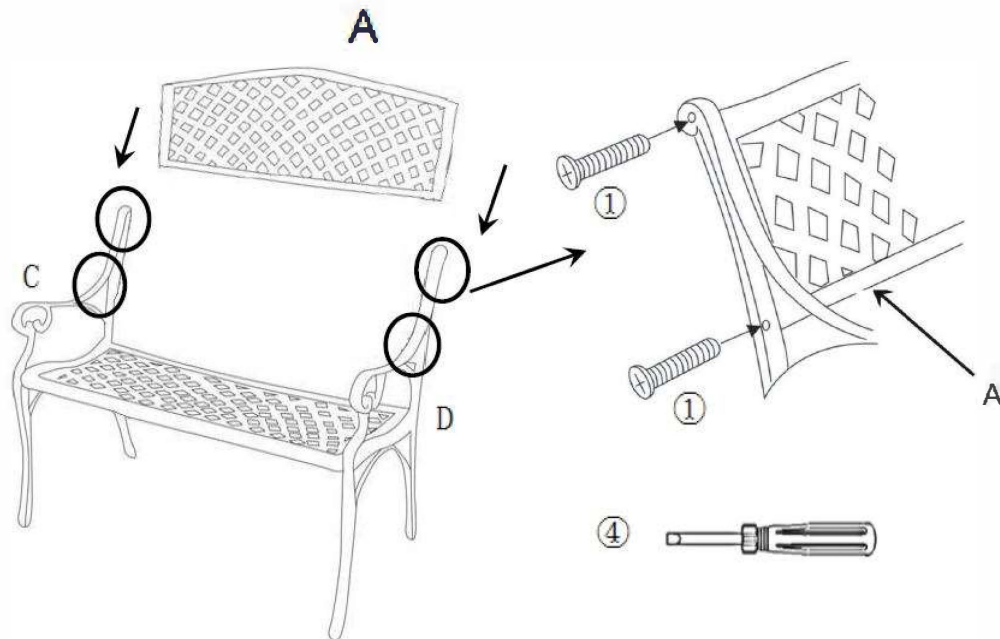

Attach Backrest Panel(A) to Left Legs Panel(C) and Right Legs Panel(D) using Bolts(①) with Screwdriver(④).

DO NOT OVERTIGHTEN, yet.

Step 4

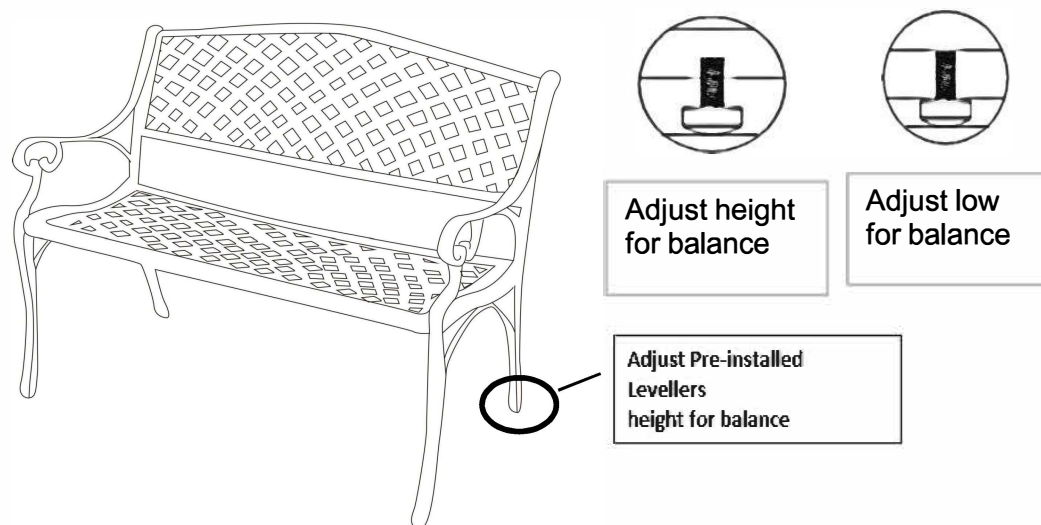









Turn the Bench rightside.

Adjust the pre-installed Levellers under bench legs until the bench is level with the ground.

Now, fully and securely, tighten all screws and bolts, at all joints.

This Bench on the now fully assembled and is ready for use.

Care & Maintenance

- ⊘  • Do not put hot items directly on furniture surface.
 - ⊘  • Do not clean furniture with harsh cleansers or polish.
 - ✓  • To obtain the longest lifespan of your outdoor products, minimizing exposure to direct sunlight is recommended.
 - ⊘  • Children should not climb or jump on the furniture.
 - ⊘  • Do not write on furniture without a padded barrier to protect the surface.
 - ✓  • To obtain the longest lifespan of your outdoor products, avoid extended and lengthy exposure to rain, snow, and direct sunshine. Whenever possible cover the product and /or place under patio or awnings.
 - ⊘  • Not for commercial use. For residential use only .
 - ⊘  • Stains may be removed with mild soap solution and damp cloth.
-
- ✓  • Dust and pick-up spills using a clean, non-colored, lint-free cloth .