

ELECTRIC FIREPLACE

User's Manual

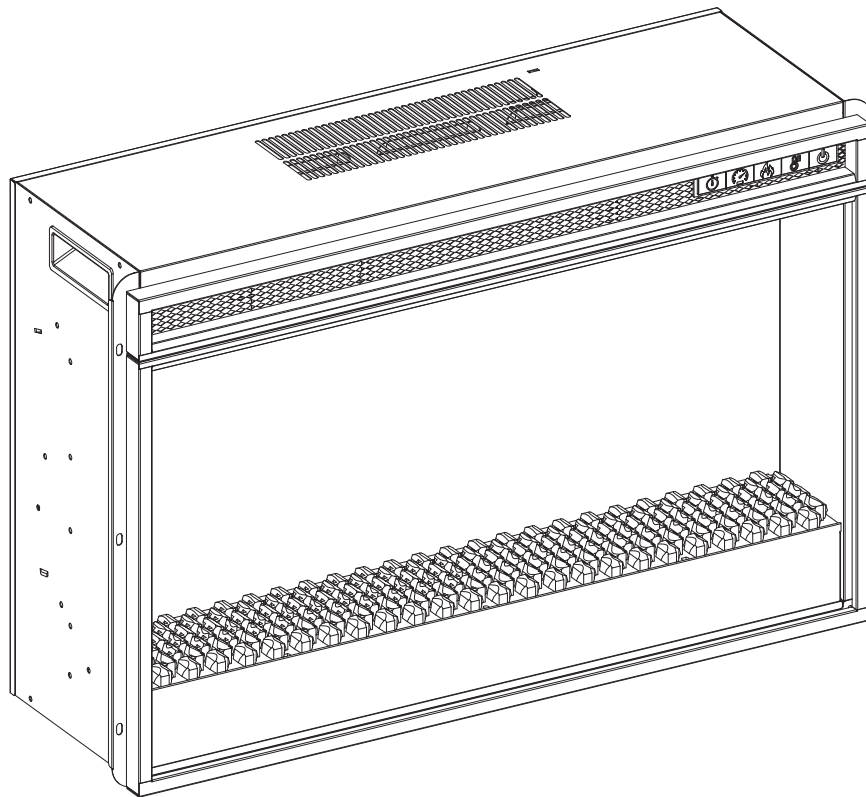

PLEASE READ THIS MANUAL CAREFULLY BEFORE USING YOUR
ELECTRIC FIREPLACE AND KEEP IT FOR FUTURE REFERENCE.

SECTION 1: BEGINNING

QUICK START GUIDE

1. Prior to first use, verify that the circuit breakers are on.
2. The heating element on this unit may emit a slight, harmless odor when first used. This odor is a normal reaction to heating the internal heater parts for the first time. This odor will dissipate and should not happen again.
3. The information regarding the model number and other specifics about this electric fireplace can be found behind the unit.

IMPORTANT - INSTRUCTIONS WARNINGS

The following instructions and precautions should be followed when using this or any heating appliance to reduce the risk of fire, electric shock, and injury to persons

1. Read all instructions before using this heater.
2. This heater is hot when in use. To avoid burns, do not let bare skin touch hot surfaces. If provided, use handles when moving this appliance. Keep combustible materials, such as furniture, pillows, bedding, papers, clothes and curtains at least 3 feet (0.9 m) from the front of the heater and keep them away from the sides and rear. **WARNING:** In order to avoid overheating, do not cover the heater. It cannot be used in a wardrobe.
3. **CAUTION:** Whenever the heater is left operating and unattended, extreme caution is necessary if children or invalids are nearby.
4. The appliance is not to be used by children or persons with reduced physical, sensory or mental capabilities, or lack of experience and knowledge, unless they have been given supervision or instruction.
5. Children being supervised not to play with the appliance.
6. Always unplug heater when not in use.
7. Do not operate any heater with a damaged cord or plug, or after the heater malfunctions, has been dropped, or damaged in any manner. Discard heater, or return to authorized service facility for examination and/or repair.
8. If the supply cord is damaged, it must be replaced by the manufacturer, its service agent or similarly qualified persons in order to avoid a hazard.
9. Any repairs to this heater should be carried out by a qualified service person.
10. Under no circumstances should this heater be modified. Parts having to be removed for servicing must be replaced prior to operating this heater again.
11. Do not use outdoors.
12. This heater is not intended for use in bathrooms, laundry areas and similar indoor locations. Never locate heater where it may fall into a bathtub or other water container.
13. Do not run cord under carpeting. Do not cover cord with throw rugs, runners or similar coverings. Do not route cord under furniture or appliances. Arrange cord away from traffic areas and where it will not be tripped over.
14. To disconnect heater, turn controls to the off setting, then remove plug from outlet.
15. Connect to properly grounded outlets only.
16. This appliance, when installed, must be electrically grounded in accordance with local codes or, in the absence

17. There is a thermostat limiter inside the heater. When the inner temperature overheats or abnormal heating occurs, the thermostat protective device would cut off power supply to avoid heater damage or risk of fire.
18. The heaters must not be located immediately below a socket-outlet.
19. Do not insert or allow foreign objects to enter any ventilation or exhaust opening as this may cause an electric shock or fire, or damage the heater.
20. To prevent a possible fire, do not block air intakes or exhaust in any manner. Do not use on soft surfaces, like a bed, where opening may become blocked.
21. A heater has hot and arcing, or sparking parts inside. Do not use it in areas where gasoline, paint, or flammable liquids are used or stored.
22. Use this heater only as described in the manual. Any other use not recommended by the manufacturer may cause fire, electric shock or injury to persons.
23. Always plug heaters directly into a wall outlet/ receptacle. Never use with an extension cord or relocatable power tap (outlet / power strip).
24. See directions in Figure 1. This heater is for use on 120 volts. The cord has a plug as shown in figure 1. See Figure 1 for groundin instruction. An adapter as shown at C is available for connecting three-blade grounding type plugs to two-slot receptacles. The green grounding plug extending from the adapter must be connected to a permanent ground such as a properly grounded outlet box. The adapter should not be used if a three-slot grounded receptacle is available.

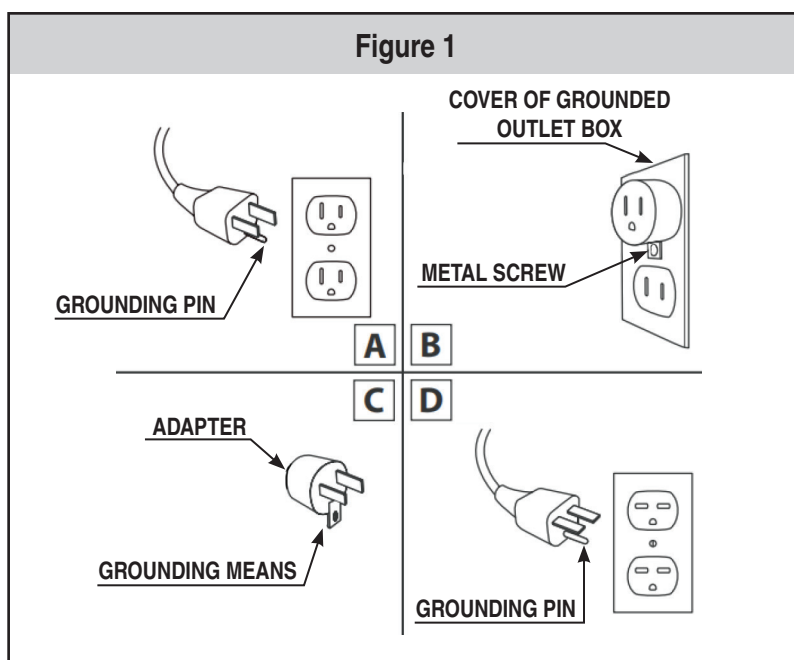

IMPORTANT: SAVE THESE INSTRUCTIONS

SECTION 2: PREPARING FIREPLACE FOR USE

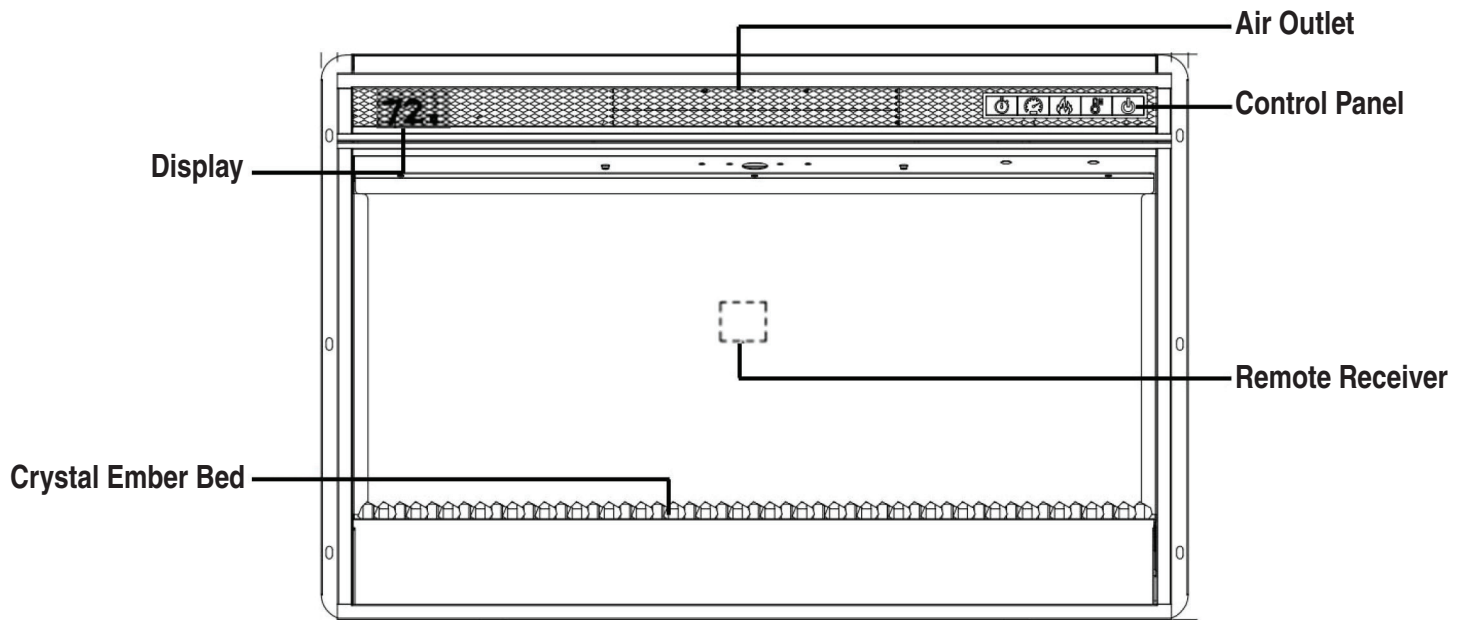

ELECTRICAL CONNECTION

A 12.5 AMP, 120 Volts, 60 Hz circuit with a properly grounded outlet is required. It's recommended that the fireplace be on a dedicated circuit, as other appliances on the same circuit may cause the circuit breaker to trip or blow the fuse when the heater is in operation.

ELECTRICAL SPECIFICATIONS	
Voltage:	120V / 60Hz
Watts:	1500 Watts
Lighting:	LED

OPERATING INSTRUCTIONS:

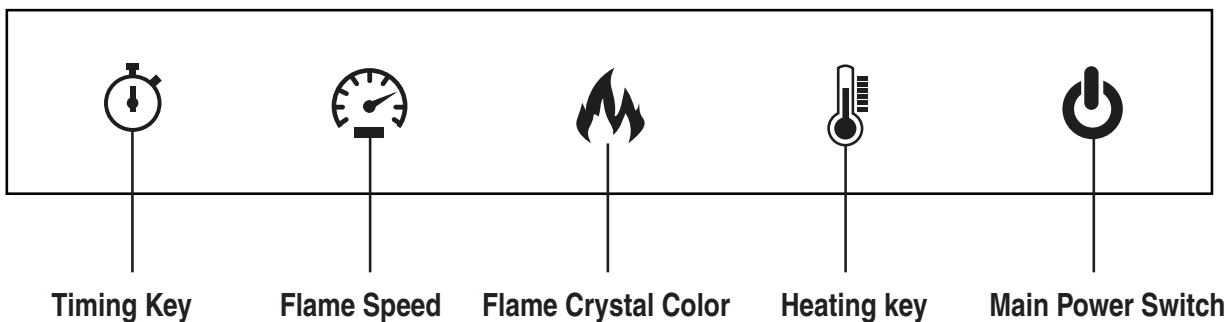



(1) On/Off Main Power Button

- a. Press to switch the unit ON/OFF.
- b. The unit will turn on to its default factory settings.
- c. Child Lock. Unit is working, press power button 5 seconds enter Child Lock mode. Log set light will flicker 5 times and can't choose any other function. Press power button 5 seconds again, then Child Lock mode will turn off.



(2) On/Off Heater Button

- a. This allows programming of the thermostat. The fireplace can be used without the heater if desired.
 - b. Adjust the temperature rating from 62°F - 82°F - ON (17°C - 27°C).
- Note: °F is the default unit. To change from Fahrenheit to Celsius: Hold the heater button for approximately 5 seconds, the temperature readout will switch directly from °F to °C and vice versa.



(3) Flame Crystal Color Button

- a. Adjust the flame Crystal Color level: 00 – L1 – L2 – L3 – L4 – L5 (Off-Blue-Amber & Blue-White-Auto change-Amber)



(4) Adjustable Flame Speed

- a. Adjust flame speed level: 1 – 2 – 3 – 4 – 5 (5 being the fastest and 1 the slowest).



(5) Adjustable Timer

- a. This allows you to control the duration of the heater function. Press the timer button until you have reached the desired duration time. Levels: 30 min -1H -2H -3H - 4H - 5H - 6H - 7H - 8H - 9H – OFF

Remote Control Operating Procedures

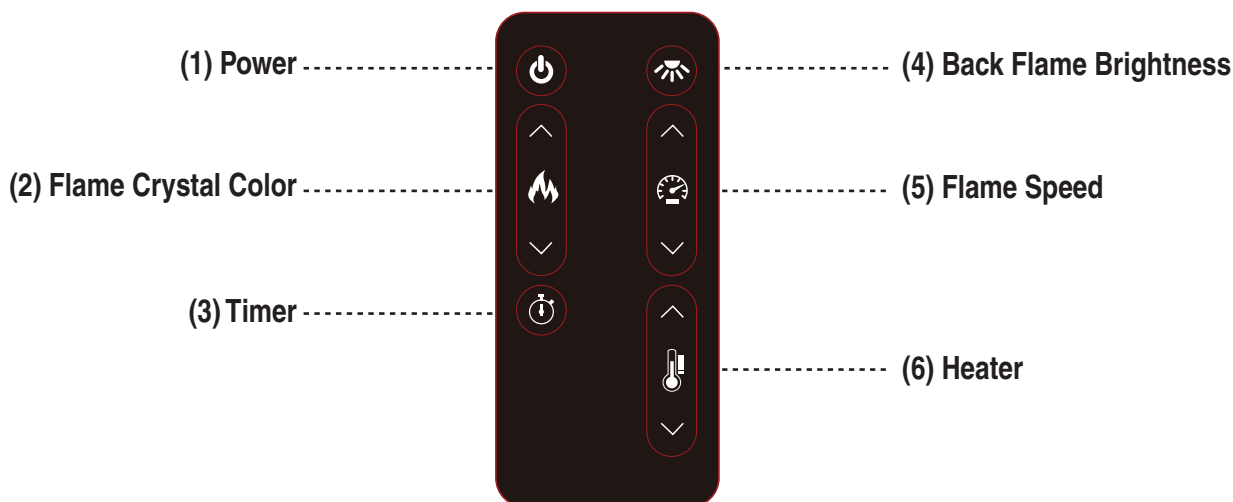

- (1) Power: Press to turn the unit ON/OFF
- (2) Flame Crystal Color level: 00 – L1 – L2 – L3 – L4 – L5 (Off-Blue-Amber & Blue-White-Auto change-Amber).
- (3) Timer: Press to adjust the duration of the heater: 30 min - 1H - 2H - 3H - 4H - 5H - 6H - 7H - 8H - 9H - OFF
- (4) Back Flame brightness: Press to adjust the level of brightness of the flame: F5- F4- F3- F2- F1- 00 OFF (F5 being the brightest and F1 the dimmest).
- (5) Flame speed: Press to adjust the level of speed of the flame: 1 – 2 – 3 – 4 – 5 (5 being the fastest and 1 the slowest).
- (6) Heater: Press to turn the heater ON/OFF. Adjust the temperature rating as follows: 62°F -- 82°F (17°C --- 27°C)

NOTE:

Do not mix old and new batteries.

Do not mix alkaline, standard (carbon zinc), or rechargeable (nicad, nimh, etc.) batteries.

REPLACING THE REMOTE CONTROL BATTERY

When the remote control stops operating or its range seems reduced, it is time to replace the battery with a new one.

1. The battery compartment is located on the back end of the remote.
2. Press and slide the battery door open and remove the old battery.
3. Insert a CR2025 battery, checking that the “+” and “-” terminals of the battery matches the inside of the battery compartment.
4. Replace the battery compartment door.

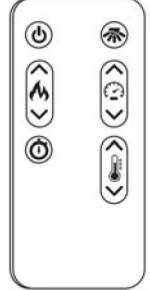

DISPOSAL OF USED BATTERIES

Battery may contain hazardous substances which could endanger the environment and human health. This symbol, marked on the battery and / or packaging, indicates that used battery shall not be treated as municipal waste. Batteries should be disposed of at an appropriate collection point for recycling. By ensuring the used batteries are disposed of correctly, you will help prevent potential negative consequences for the environment and human health. The recycling of materials will help to convert natural resources. For more information about recycling of used batteries, please contact your local municipality waste disposal service.



NOTE: PLEASE OPERATE REMOTE TRANSMITTER AT A SLOW MEASURED PACE. PRESS THE REMOTE CONTROL BUTTONS WITH AN EVEN MOTION AND GENTLE PRESSURE. REPEATEDLY PRESSING BUTTONS IN RAPID SUCCESSION MAY CAUSE TRANSMITTER MALFUNCTION.

PRODUCT SIZE (mm)

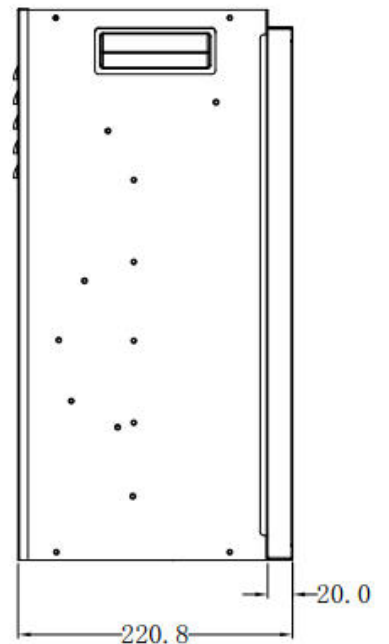
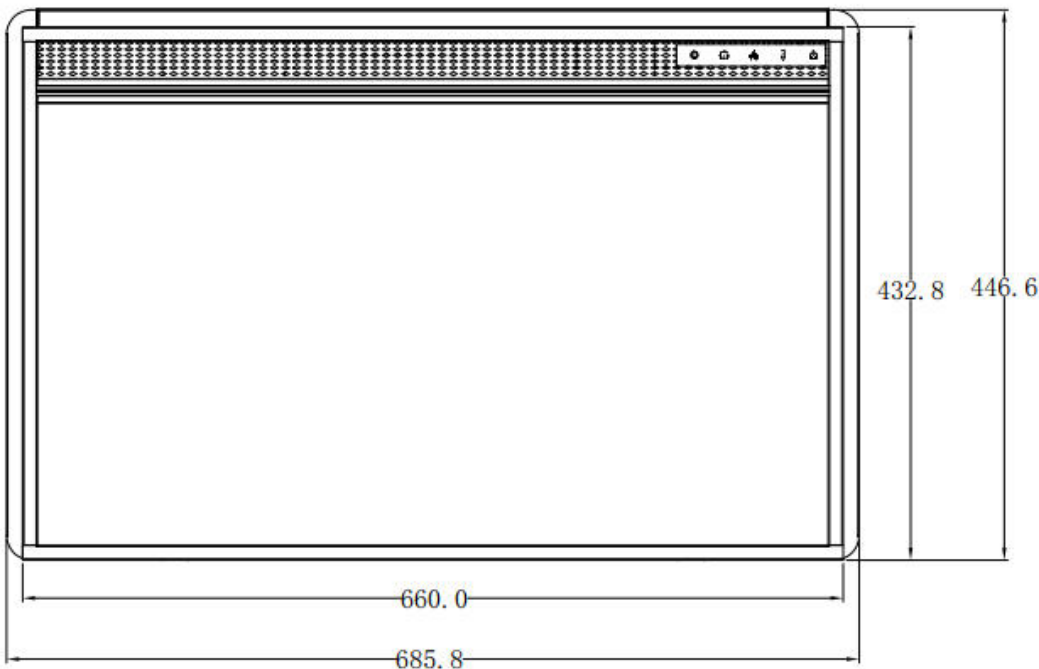

INSTALLING THE CRYSTAL BEADS

ELECTRIC FIREPLACE

STEP 1

- Remove the four screws at the corners of glass frame assembly. Lift up and remove the front glass assembly away from the firebox. Carefully pour the decorative crystal beads onto the tray.

CAUTION: This insert has front panel made of GLASS! ALWAYS use extreme caution when handling glass. Failure to do so could result in personal injury or property damage.

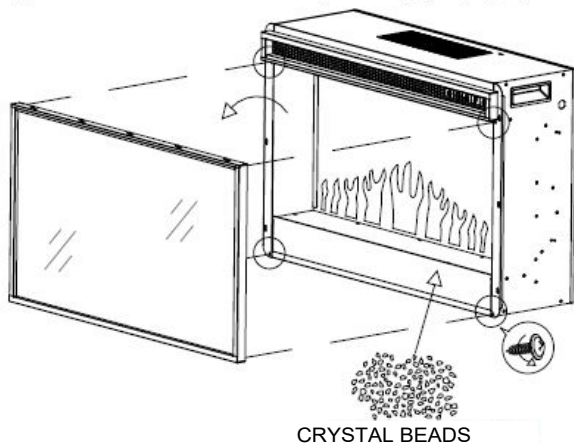

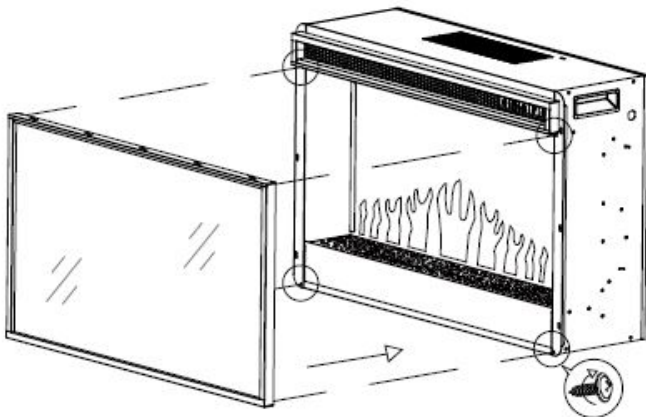

STEP 2

- Replace the glass frame assembly into the unit. Align the screw holes and tighten the four screws in place to secure the front glass assembly.



 **WARNING:** Make sure the power is turned off before proceeding. Any electrical repairs or rewiring of this unit should be carried out by a licensed electrician in accordance with national and local codes. If repairing or replacing any electrical component or wiring, the original wire routing, color coding and securing locations must be followed.

 **WARNING:** Electrical outlet wiring must comply with local building codes and other applicable regulations to reduce the risk of fire, electrical shock and injury to persons.

 **WARNING:** Do not use this fireplace if any part of it has been under water. Immediately call a qualified service technician to inspect the fireplace and replace any part of the electrical system.

 **WARNING:** Disconnect power before attempting any maintenance or cleaning to reduce the risk of fire, electrical shock or personal injury.

 **WARNING:** During any service of this appliance, the power to the unit must be turned off. First, turn the main power switch to the “OFF” position. Then, remove the electrical plug from the wall outlet.

LITHIUM BATTERY WARNING

 **WARNING: Chemical Burn Hazard. Keep batteries away from children.**

This product contains a lithium button/coin cell battery. If a new or used lithium button/coin cell battery is swallowed or enters the body, it can cause severe internal burns and can lead to death in as little as 2 hours. Always completely secure the battery compartment. If the battery compartment does not close securely, stop using the product, remove the batteries, and keep it away from children. If you think batteries might have been swallowed or placed inside any part of the body, seek immediate medical attention.

TROUBLE SHOOTING

Problem	Root Cause	Corrective Action
Display Shows "E2/E3"	The thermostat sensor has some problem	Inspect the heater and check that the air inlets and outlets are not blocked as this may cause overheating. Unplug the heater for 30 minutes and allow it to cool down. Re-plug and operate, monitor the heater for signs of overheating, if the problem persist discontinue use of the heater and contact customer service.
Heater does not blow warm air.	Cool down cycle.	Normal operation, will continue to run for several minutes before shutting down. Temperatures will vary based on times. During this time cool air will blow.
No power, crystals do not glow	No power to the unit	Check that unit is plugged into a standard 120V outlet. Press power button several times, make sure power is set at "ON" position.
Crystal glow, but no flame effect	Flame effect turned off	Press flame button several times.
Heater does not blow warm air	Thermostat setting is preventing heater from turning on	Adjust the temperature settings to ensure that the thermostat is set higher than the current room temperature.
Remote Control is not working	No batteries	Change the remote batteries.
	Poor signal	Operate remote transmitter at a slow measured pace. Press the remote control buttons with an even motion and gentle pressure. Repeatedly pressing buttons in rapid succession may cause the transmitter to malfunction.
	Distance	Operate the remote at a distance less than 20 feet from the front of the appliance; point the remote at the control panel.

FCC INSTRUCTIONS

NOTE: This equipment has been tested and found to comply with the limits for a Class B digital device, pursuant to Part 15 of the FCC Rules. These limits are designed to provide reasonable protection against harmful interference in a residential installation. This equipment generates, uses and can radiate radio frequency energy and, if not installed and used in accordance with the instructions, may cause harmful interference to radio communications. However, there is no guarantee that interference will not occur in a particular installation. If this equipment does cause harmful interference to radio or television reception, which can be determined by turning the equipment off and on, the user is encouraged to try to correct the interference by one or more of the following measures:

- Reorient or relocate the receiving antenna.
- Increase the separation between the equipment and receiver.
- Connect the equipment into an outlet on a circuit different from that to which the receiver is connected.
- Consult the dealer or an experienced radio/TV technician for help.

-- This device complies with Part 15 of the FCC Rules. Operation is subject to the following two conditions: (1) This device may not cause harmful interference, and (2) this device must accept any interference received, including interference that may cause undesired operation.

-- Instructions shall caution users that modifications not approved by the party responsible for compliance could void user's authority to operate the equipment.

IMPORTANT: SAVE THESE INSTRUCTIONS