

Assembling Instruction & Parts List

Item No.	Cat Litter Box Enclosure	Height	
		800 jÅ 559 jÅ 508 mm	

No.	Description	Measurement in mm	Quantity
No. 1	Right Door Plate		1
No. 2	Left Door Plate		1
No. 3	Top Panel		1
No. 4	Bottom Plate		1
No. 5	Right Side Panel		1
No. 6	Left Side Panel		1
No. 7	Middle Side Panel		1
No. 8	Back Panel		1
No. 9	Front Drawbar Panel		1
No. a	Cam Lock		18
No. b	Bolt for Cam Lock		18
No. c	Sticker		18
No. d	Dowel Ø40mm		18
No. e	Countersunk screw 4*14mm		2
No. f	Hinge		4
No. g	Closing Latch, Magnetic		1
No. h	Feet Screw		4
No. i	Knob		2
No. j	Iron frame		1
No. k	CAT24 Scratcher		1
No. l	Countersunk screw 4*12mm		4
No. m	Countersunk screw 4*16mm		24
No. n	Feet Screw 4*30		8

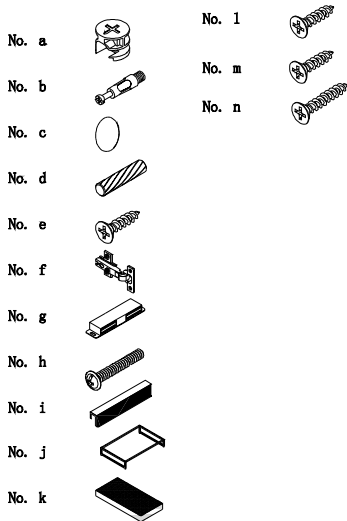
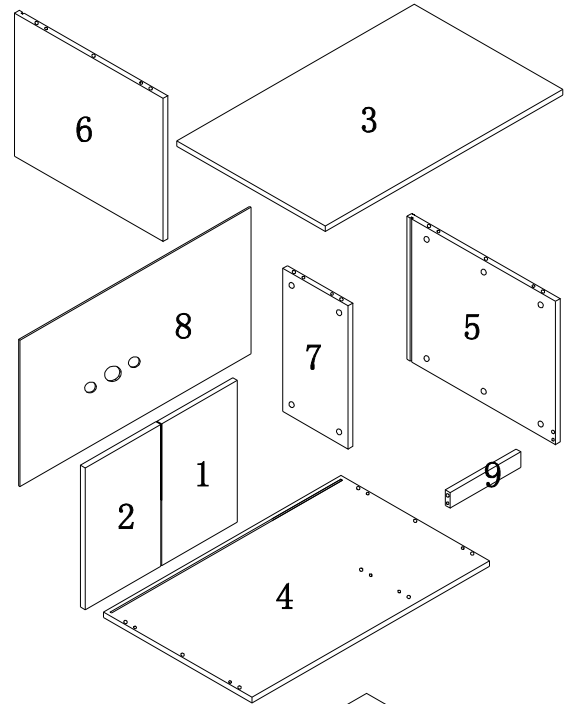

Advice:

Do not sit or stand on this product.
It is intended for pets only.
This product should be assembled by an adult.

For the convenience and neatness of reading the manual, the door panel here is displayed using a simple drawing method.

