

Assembly Instructions

Caution: You must read this before you proceed

Please look underneath the Seat Panel for hardware packs

Chair

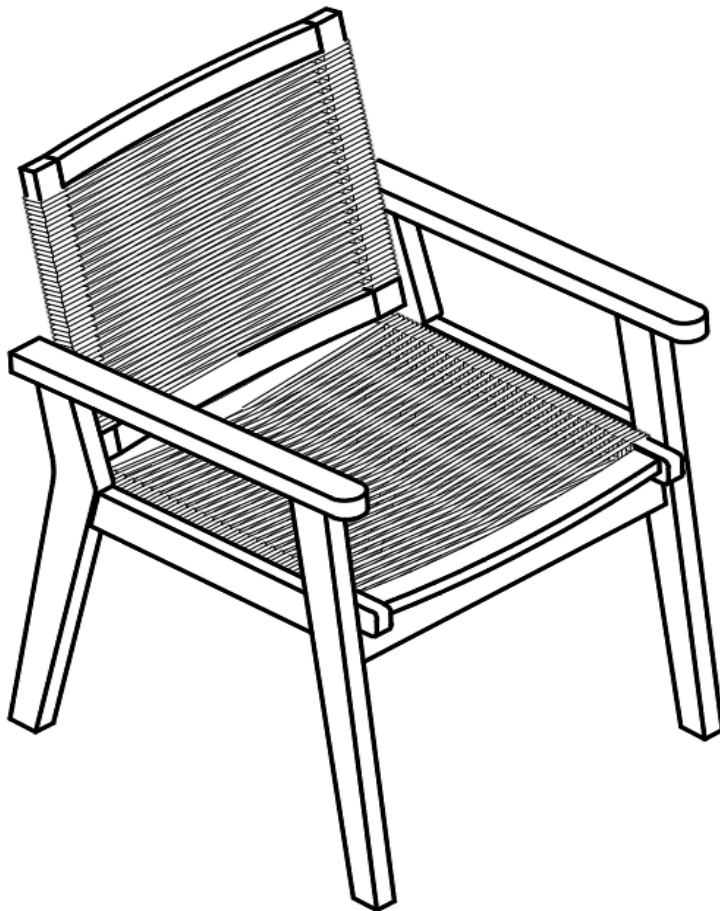

CAUTION: This Chair is NOT a TOY.



Keep your child / children at bay during the assembly process.

For turning the Chair and to prevent damage to the Chair, 02 persons may be needed to execute this action

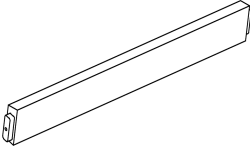
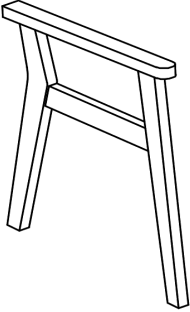
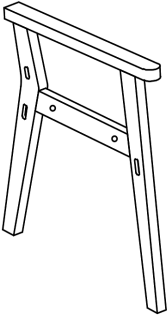
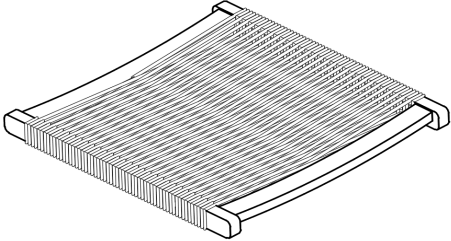
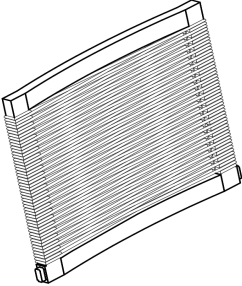
Parts List

Label	Picture	Description	QTY
A	 A long, thin, rectangular wooden bar with a slightly curved profile and a small notch at one end.	Support bar	2
B	 A wooden panel forming the left side of a chair's leg assembly, featuring a curved top rail and two legs.	Left Leg Panel	1
C	 A wooden panel forming the right side of a chair's leg assembly, similar to the left leg panel but with a different internal structure.	Right Leg Panel	1
D	 A rectangular wooden panel with a curved top and bottom edge, featuring a dense grid of horizontal slats.	Seat Panel	1
E	 A rectangular wooden panel with a curved top and bottom edge, featuring a dense grid of horizontal slats, similar to the seat panel but oriented vertically.	Back Panel	1

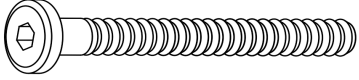
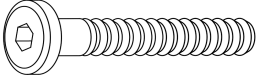
Hardware

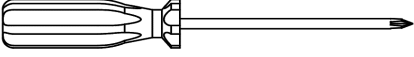
Label	Picture	Description	QTY
①		Bolt (M6x65 mm)	3
②		Bolt (M6x45 mm)	5
③		Screw (M5x50 mm)	5
④		Allen Key	1
⑤		Screwdriver (Not provided)	1

Assembly Preparation

Before Beginning Assembly:

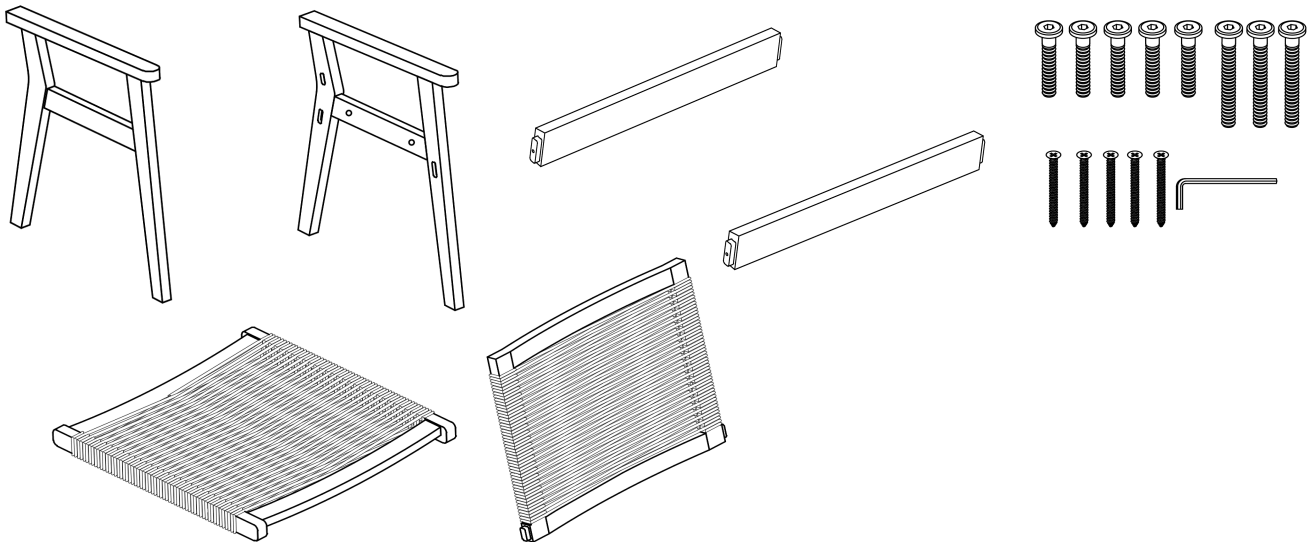

- Read instructions, cover to cover-



- Have 2 adults on hand for assembly-



- Do not assemble on flooring or carpet-



- Assemble on a clean non-marring surface (packing foam)-



- Save all packaging until finished-

Assembly Steps

Overview

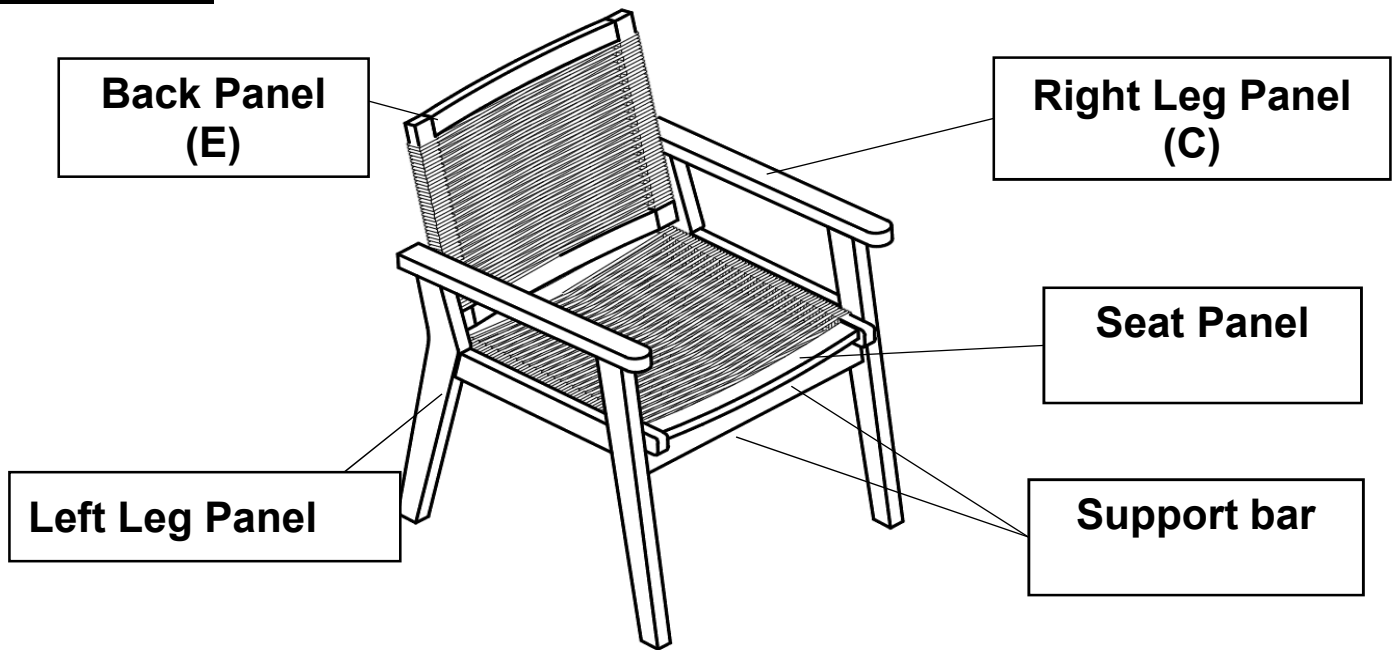

This Chair has multiple parts and may require up to 30 minutes to assemble. To give you an overview of the Chair, the above picture is to help you put the various parts into perspective. Please read through the instructions below to familiarise yourself with the parts and steps before assembly.

Step 1

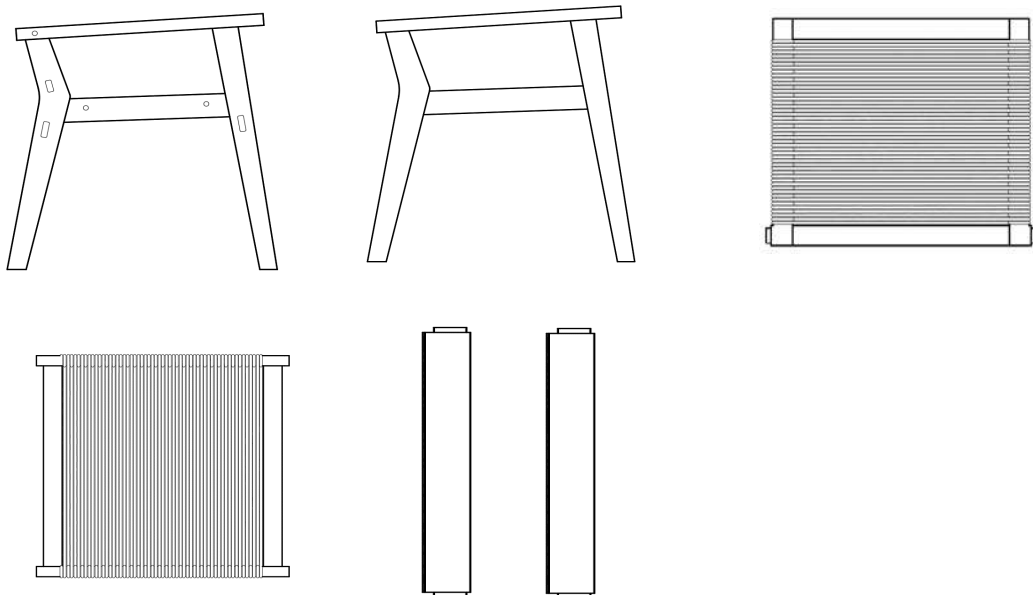

Unpack and place all parts on a clean, non-marring surface.

Step 2

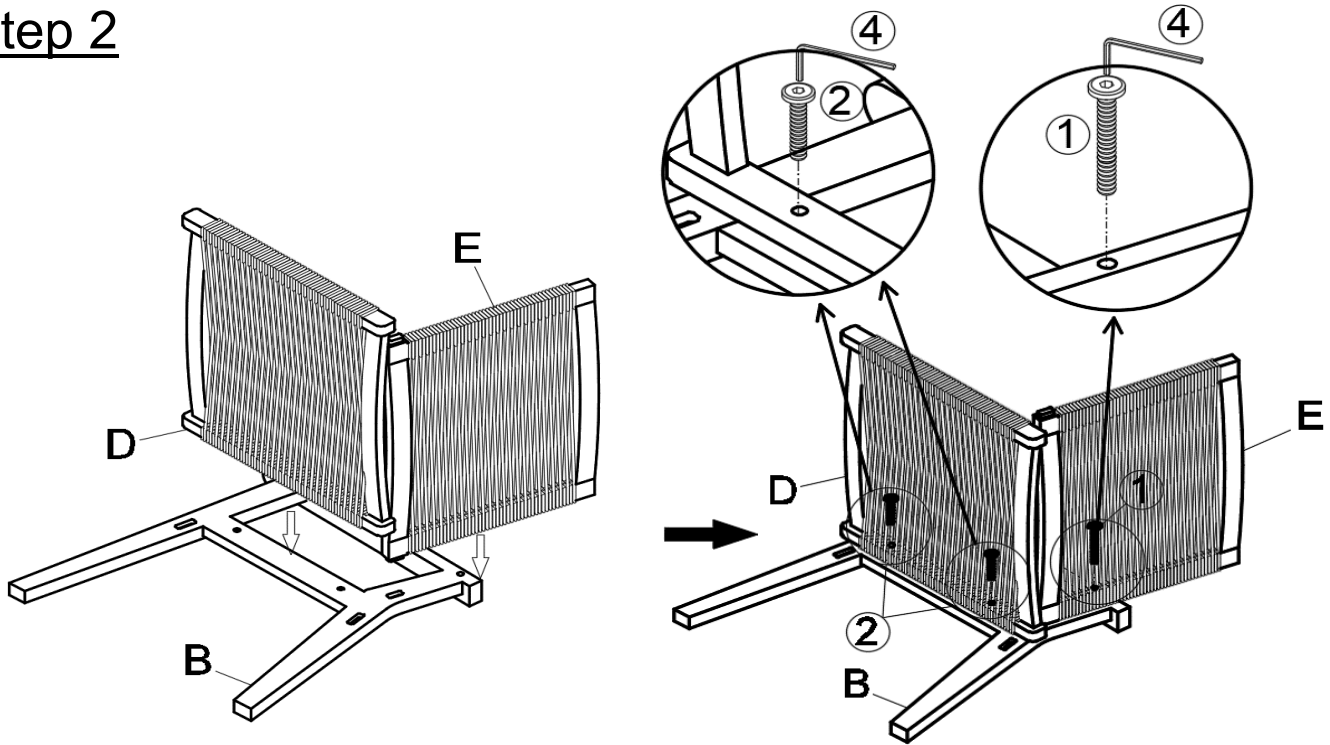

Position the Seat Panel (D) and Back Panel (E) to the Left Leg Panel (B) as shown in the above picture.

Attach the Seat Panel (D) and Back Panel (E) to the Left Leg Panel (B) using Bolt (①), Bolts (②) and Allen Key (④).

Do not fully tighten the Bolts.

Step 3

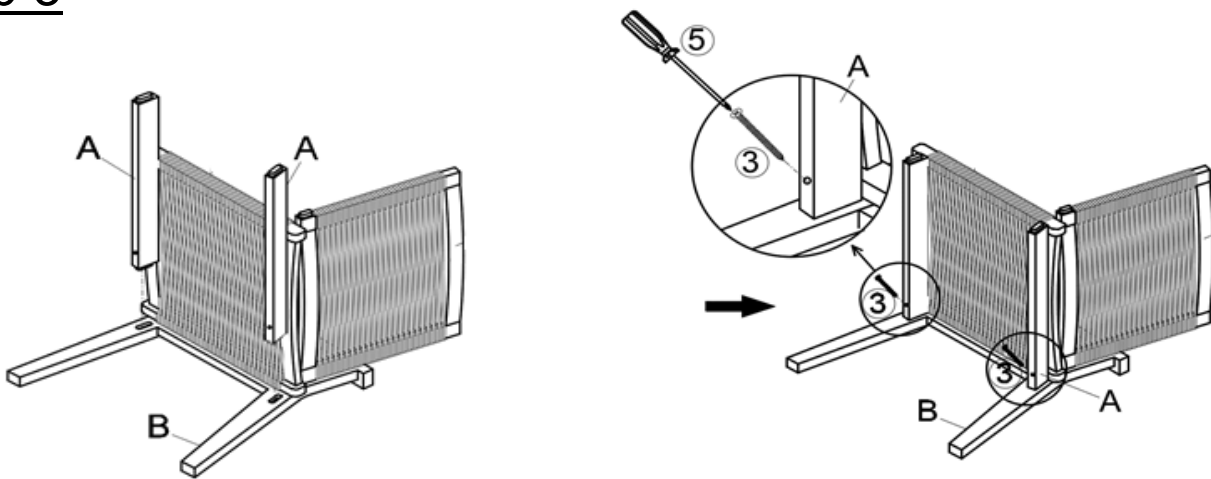

Position the Support bar (A) to the Left Leg Panel (B) as shown in the above picture.

Then using the Screw (③) and Screwdriver (⑤) to secure the Support bar (A) to the Left Leg Panel (B) .

Repeat the same step with the remaining Support Bar.

Do not fully tighten the Screws.

Step 4

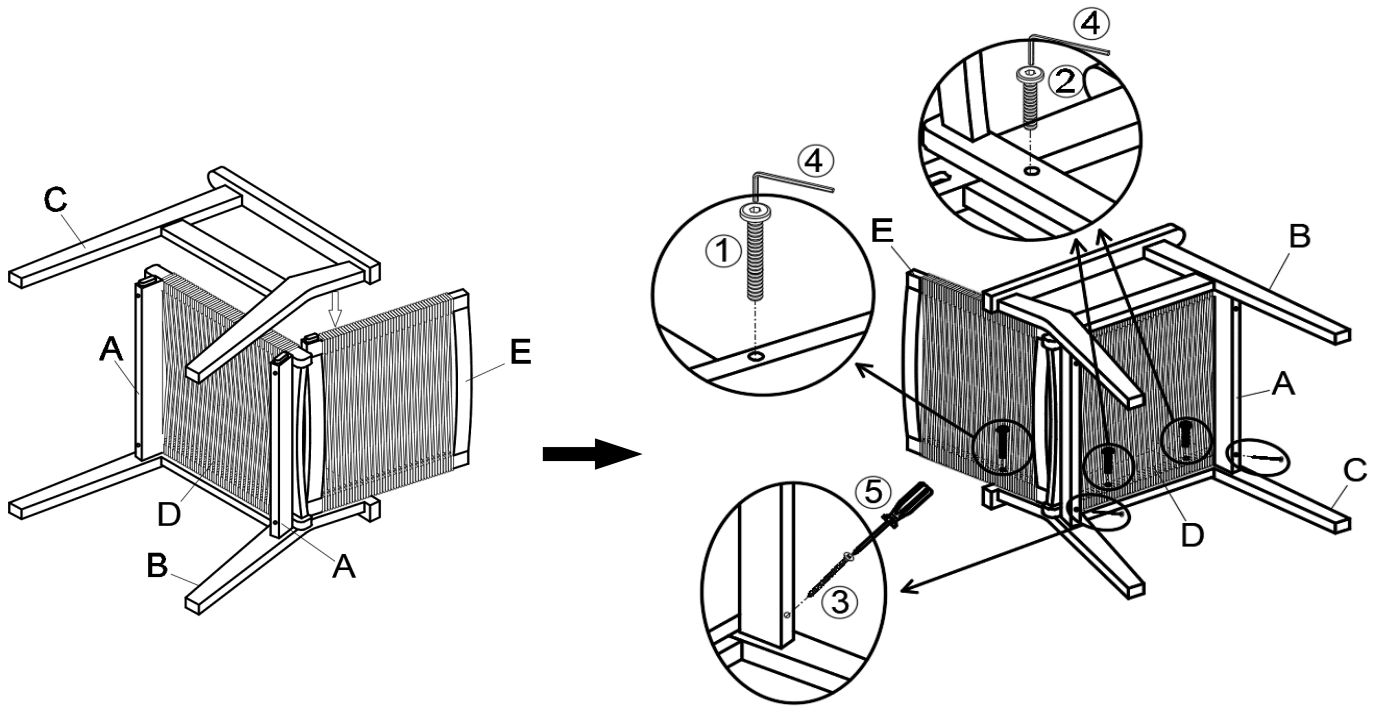

Position the Right Leg Panel (C) to the assembled parts in step 3 and turn the Chair into the opposite side as shown in the above picture.

4.1. Secure the Seat Panel (D) to the Right Leg Panel (C) using Bolts(②) and Allen Key (④)

4.2. Secure the Back Panel (E) to the Right Leg Panel (C) using Bolt (①) and Allen Key (④).

4.3. Secure the Support bars (A) to the Right Leg Panel (C) using the Screws (③) and Screwdriver (⑤).

Do not fully tighten the Bolts, Screws.

Step 5

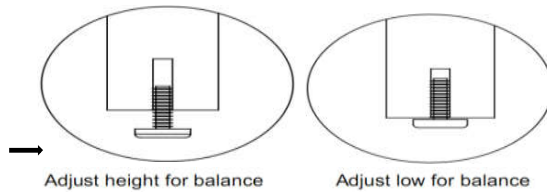
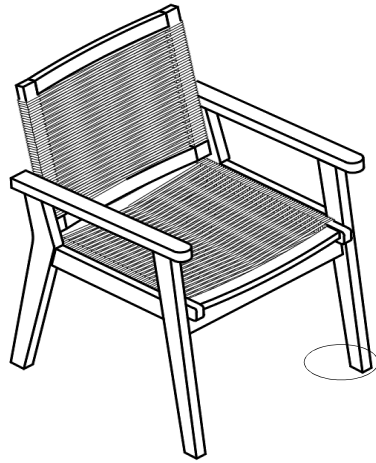





















Adjust Pre-installed

With the assistance from your adult partner, stand the Chair up
Inspect the Chair and make sure all parts are adequately connected.
Carefully sit onto the Chair. This pressure will help align all parts at all joints.
In a sequential manner, tighten all Bolts and Screws at all joints.
Adjust the Levellers until the Chair is level with the ground.

To adjust the Levellers, get assistance from an adult partner to lift/lean and hold the Chair while you are working.

Care & Maintenance

-   ● Do not put hot items directly on furniture surface
-   ● Do not clean furniture with harsh cleansers or polish.
-   ● To obtain the longest lifespan of your outdoor products, minimizing exposure to direct sunlight is recommended.
-   ● Children should not climb or jump on the furniture.
-   ● Do not write on furniture without a padded barrier to protect the surface.
-   ● To obtain the longest lifespan of your outdoor products, avoid extended and lengthy exposure to rain, snow, and direct sunshine. Whenever possible cover the product and /or place under patio or awnings.
-   ● Not for commercial use. For residential use only .
-   ● Stains may be removed with mild soap solution and damp cloth.
-   ● Keep away from sources of ignition.
-   ● Dust and pick-up spills using a clean, non-colored, lint-free cloth.