

Assembly Instructions

Instructions de Montage

Case & Maintenance / Entretien et Maintenance



Not for commercial use. For residential use only.
Non destiné à un usage commercial. Pour usage résidentiel uniquement.



Furniture may scratch floors. We recommend using furniture pads to protect your floors.
Les meubles peuvent rayer les sols. Nous recommandons d'utiliser des patins pour meubles afin de protéger vos sols.



Do not put hot items directly on furniture surface.
Ne posez pas d'objets chauds directement sur la surface des meubles.



Do not clean furniture with harsh cleansers or polish.
Ne nettoyez pas les meubles avec des produits de nettoyage agressifs ou du polish.



Do not place furniture under direct sunlight.
Ne placez pas les meubles sous la lumière directe du soleil.



Do not write on furniture near heating or cooling vents.
Ne pas écrire sur les meubles à proximité des bouches de chauffage ou de climatisation.



Do not write on furniture without a padded barrier to protect the surface.
Ne pas écrire sur les meubles sans une protection rembourrée pour préserver la surface.



Do not place furniture outside for indoor use only
Ne placez pas les meubles à l'extérieur, usage intérieur uniquement.



Stains may be removed with mild soap solution and damp cloth.
Les taches peuvent être enlevées avec une solution savonneuse douce et un chiffon humide.



Children should not climb or jump on the furniture.
Les enfants ne doivent pas grimper ni sauter sur les meubles.



Dust and pick-upspills using a clean, non-colored, lint-free cloth.
Dépoussiérez et essuyez les déversements avec un chiffon propre, non coloré et sans peluches.

Please look in the box for hardware packs and legs.

Veuillez vérifier dans la boîte la présence des kits de quincaillerie et des pieds.

Sets oftenship in multiple boxes and may arrive a day or two apart.

Les ensembles sont souvent expédiés dans plusieurs colis et peuvent arriver un jour ou deux à des dates différentes.

King Bed N709P406301A

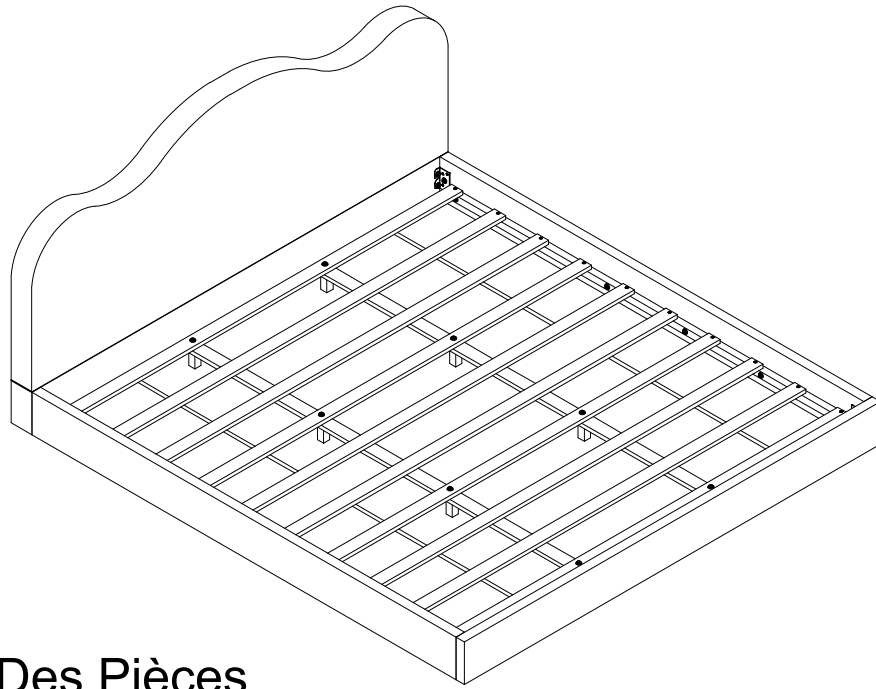

Part List / Liste Des Pièces

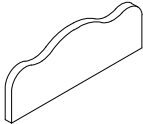
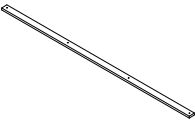
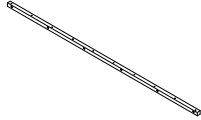
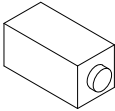
Label Étiquette	Picture Image	Description Description	Quantity Quantité
①		Headboard Tête De Lit	1
⑦		Middle Support Bar Barre Centrale De Lit	2
⑧		Support Rail Rail De Support	2
⑨		Center Support Leg Pied De Support Central	8

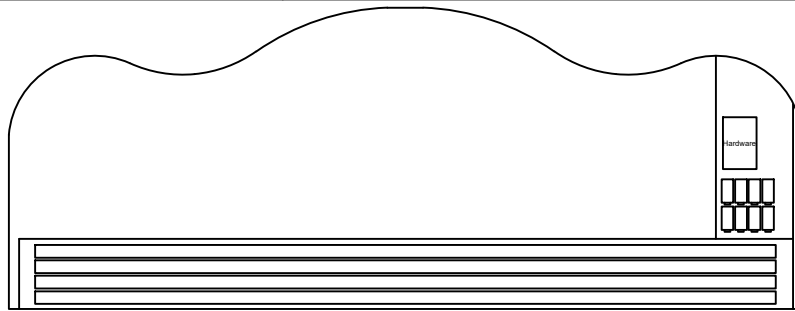





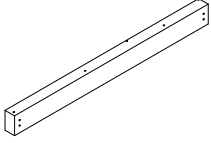
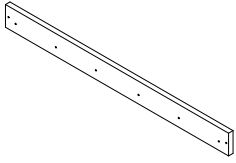
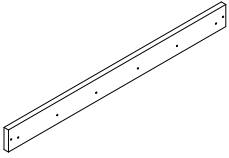
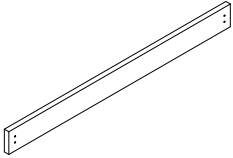
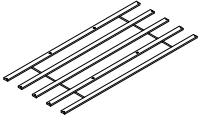

Noted: Middle Support Bar (7), Support Rail (8), Center Support Leg (9) and Hardware are packed behind the Headboard (1).

À noter: la Barre Centrale de Lit (7), le Rail de Support (8), le Pied de Support Central (9) et la quincaillerie sont emballés derrière la Tête de Lit (1).

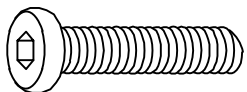
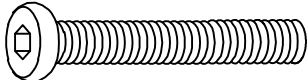
Part List / Liste Des Pièces

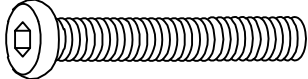
Label Étiquette	Picture Image	Description Description	Quantity Quantité
②		Headboard Storage Tête De Lit Avec Rangement	1
③		Side Rail Right Rail Latéral Droit	1
④		Side Rail Left Rail Latéral Gauche	1
⑤		Footboard Pied De Lit	1
⑥		Slats Lattes	2

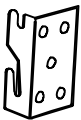
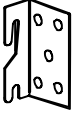
Hardware / Quincaillerie









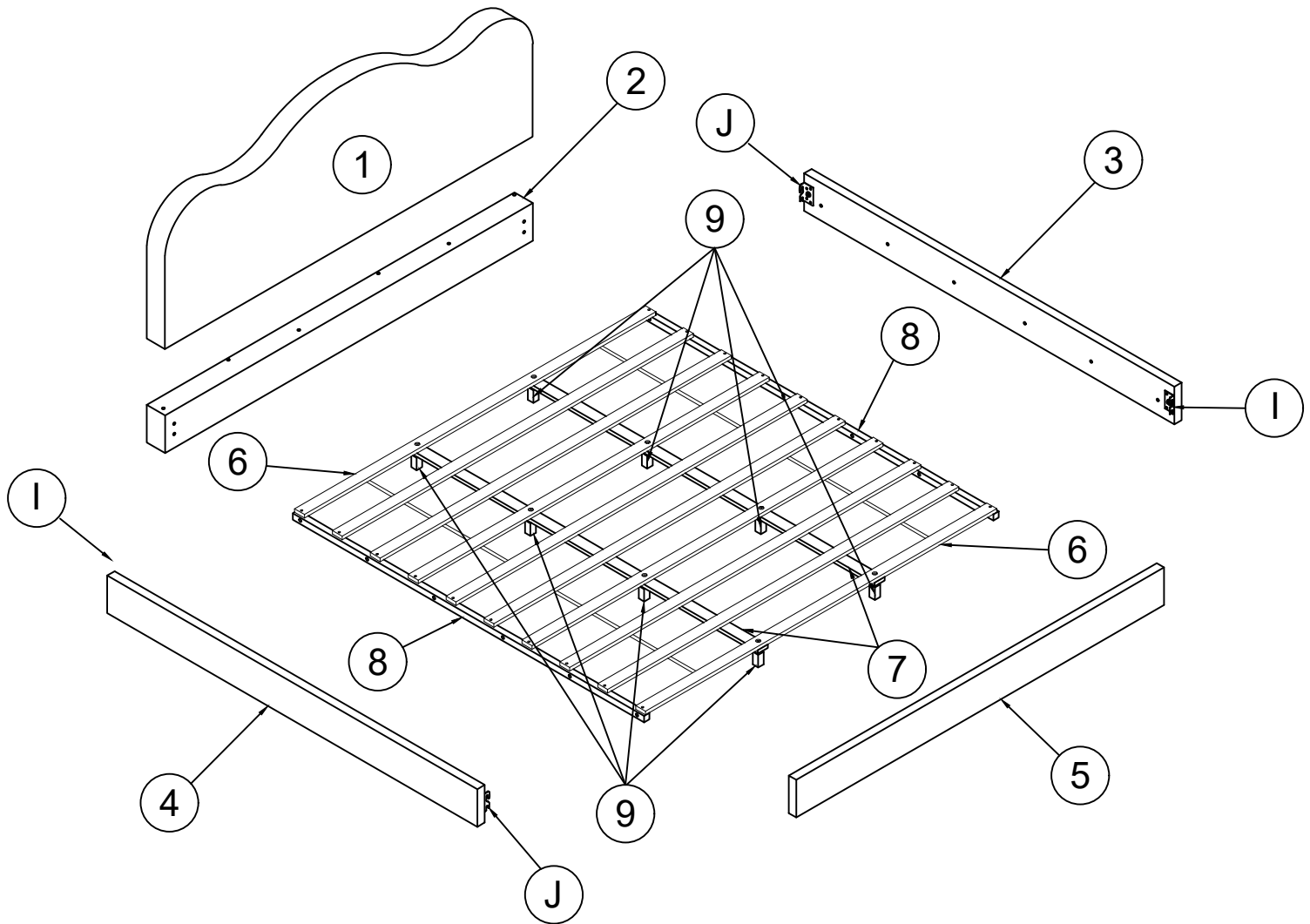

Label Étiquette	Picture Image	Description Description	Quantity Quantité
(A)		Screw(4x30mm) Vis(4x30 mm)	36+1
(B)		Bolts(5/16"x30mm) Boulons(5/16"x30 mm)	12+1
(C)		Bolts(5/16"x50mm) Boulons(5/16"x50mm)	18+1
(D)		Lock Washer(5/16") Rondelle frein(5/16")	30+1
(E)		Flat Washer(5/16") Rondelle plate(5/16")	30+1
(F)		Bolts(1/4"x50mm) Boulons(1/4"x50mm)	8+1
(G)		Lock Washer(1/4") Rondelle frein(1/4")	8+1
(H)		Flat Washer(1/4") Rondelle plate(1/4")	8+1
(I)		Left Metal Bracket Équerre de rail de lit en métal gauche	2
(J)		Right Metal Bracket Équerre de rail de lit en métal droite	2
(K)		Allen Key(M4) Clé Allen (M4)	1+1

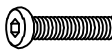



Assembly Preparation / Préparation à l'assemblage

Before Beginning assembly:

Avant de commencer l'assemblage:



A	 x 36pcs+1	B	 x 12pcs+1	C	 x 18pcs+1	D	 x 30pcs+1
E	 x 30pcs+1	F	 x 8pcs+1	G	 x 8pcs+1	H	 x 8pcs+1
I	 x 2pcs	J	 x 2pcs	K	 x 1pc+1		

-  Read the instructions cover to cover
Lisez les instructions de bout en bout
-  Have 2 adults on hand for assembly
Prévoir 2 adultes pour l'assemblage
-  Do not assemble on flooring or carpet
Ne pas assembler sur le sol ou la moquette
-  Assemble on a clean, non-marring surface
Assemblez sur une surface propre et non rayante
-  Save all packaging until finished
Conservez tous les emballages jusqu'à la fin

Assembly Steps / Étapes d'assemblage

OVERVIEW / Vue d'ensemble

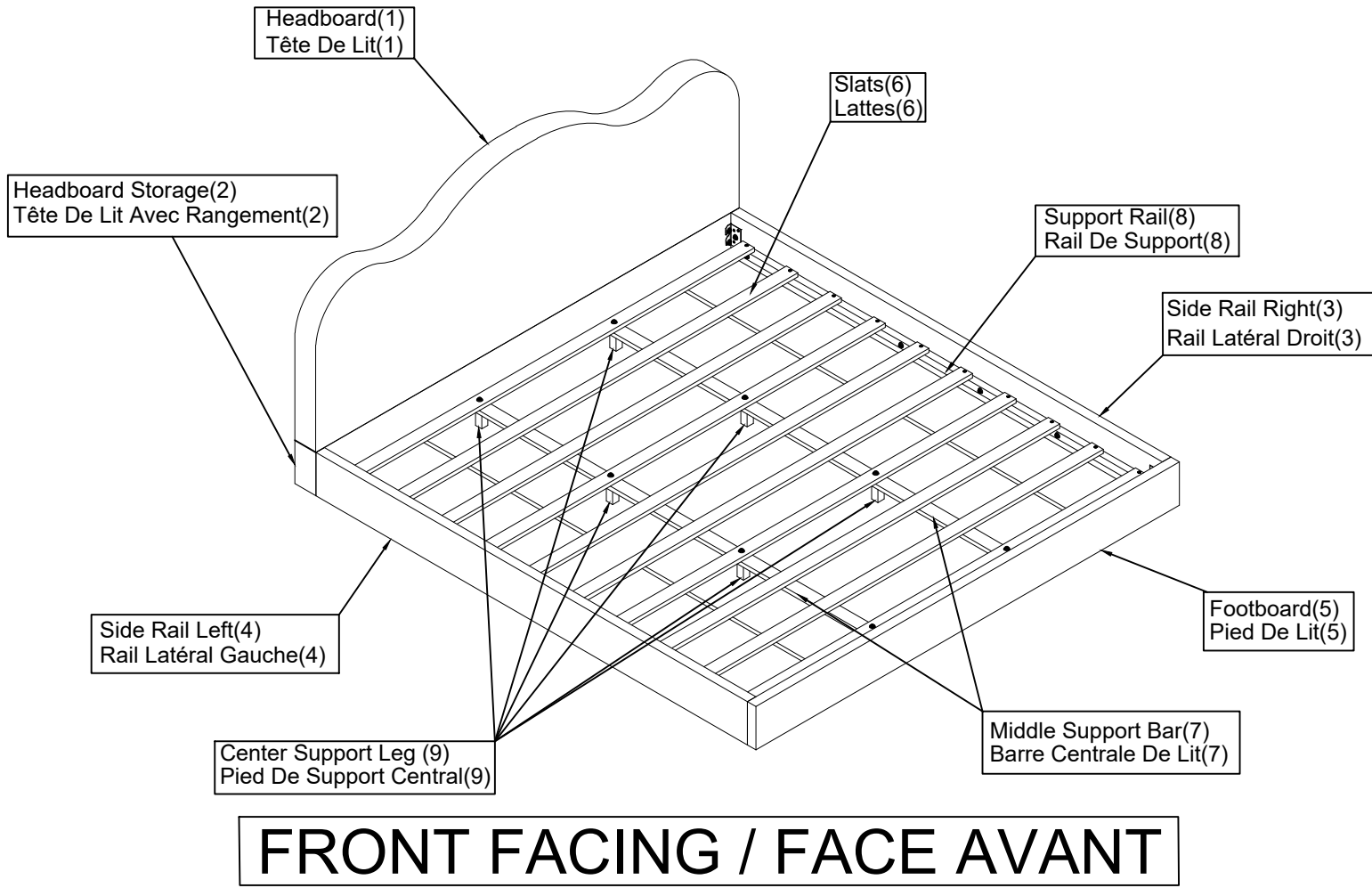

-This Bed have multiple parts and may require up to 30 minutes to assemble.
-Ce lit comporte plusieurs pièces et peut nécessiter jusqu'à 30 minutes pour être assemblé.

-To give you an overview of the Bed parts, the above picture is to help you put the various parts into perspective. Please read through the instructions below to familiarise yourself with the parts and steps before assembly.

-Pour vous donner une vue d'ensemble des pièces du lit, l'image ci-dessus est destinée à vous aider à situer les différentes parties. Veuillez lire attentivement les instructions ci-dessous afin de vous familiariser avec les pièces et les étapes avant l'assemblage.

Note: It is recommended that you have an adult partner to assist during the entire assembly process.

Remarque: Il est recommandé d'avoir un adulte pour vous aider tout au long du processus d'assemblage.

Step 1 / Étape 1

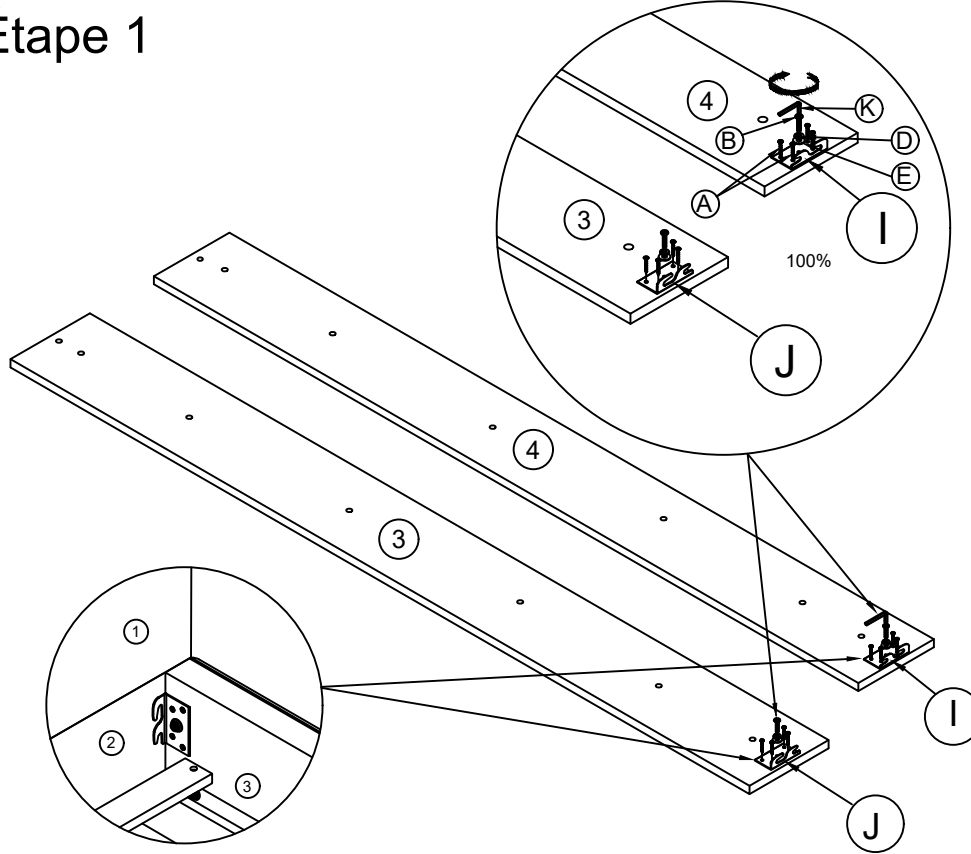

A		x8 pcs
4x30mm		
B		x2 pcs
5/16"x30mm		
D		x2 pcs
5/16"		
E		x2 pcs
5/16"		
I		x1 pc
J		x1 pc
K		100%
M4		

Attach the Right Metal Bracket(J) to the Side Rail Right(3), Left Metal Bracket(I) to the Side Rail Left(4), by Screw(A) Bolts(B), Lock Washer(D) and Flat Washer(E) with Allen Key(K).

Fixez l'équerre de rail de lit en métal droite (J) au rail latéral droit (3), et l'équerre de rail de lit en métal gauche (I) au rail latéral gauche (4), à l'aide de la vis (A), des boulons (B), de la rondelle frein (D) et de la rondelle plate (E), en utilisant la clé Allen (K).

Step 2 / Étape 2

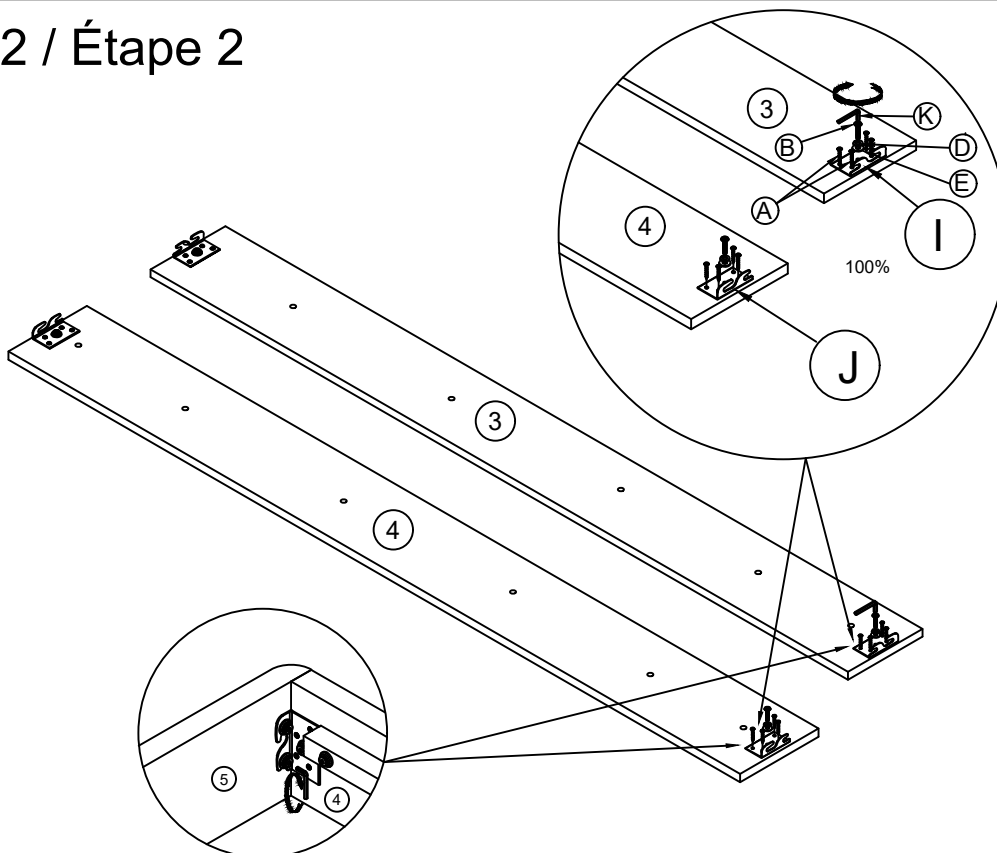

A		x8 pcs
4x30mm		
B		x2 pcs
5/16"x30mm		
D		x2 pcs
5/16"		
E		x2 pcs
5/16"		
I		x1 pc
J		x1 pc
K		100%
M4		

Attach Left Metal Bracket (I) to the Side Rail Right (3), attach Right Metal Bracket (J) to the Side Rail Left (4), by using Screw (A), Bolts (B), Lock Washer (D) and Flat Washer (E) with Allen Key (K).

Fixez l'équerre de rail de lit en métal gauche (I) au rail latéral droit (3), et fixez l'équerre de rail de lit en métal droite (J) au rail latéral gauche (4), à l'aide de la vis (A), des boulons (B), de la rondelle frein (D) et de la rondelle plate (E), en utilisant la clé Allen (K).

Step 3 / Étape 3

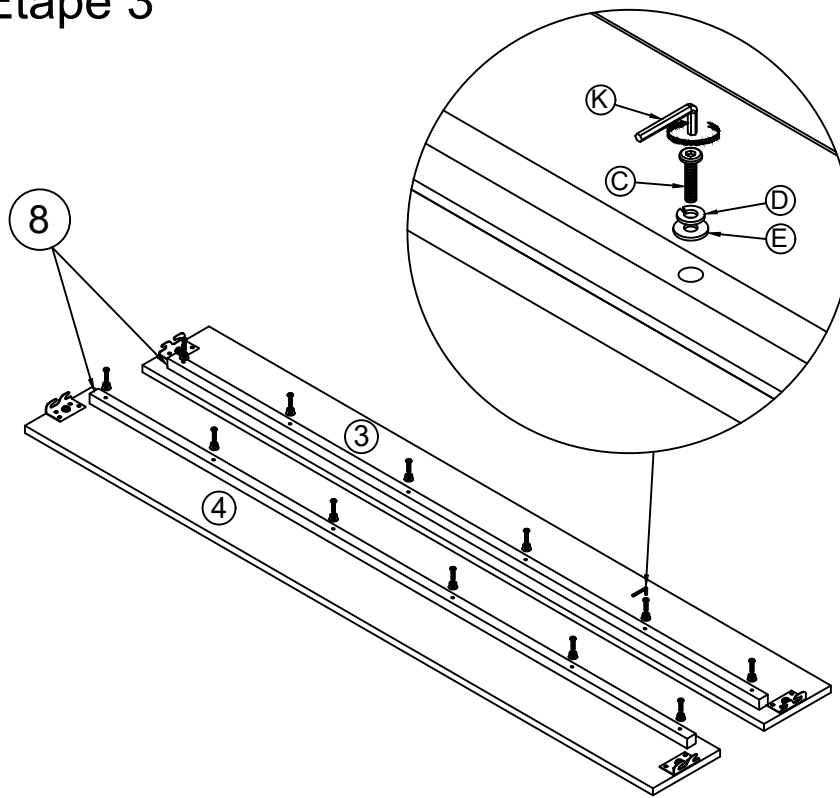

C x12 pcs
5/16"x50mm

D x12 pcs
5/16"

E x12 pcs
5/16"

K M4 100%

Attach the Support Rail (8) to the Side Rail (3) and the Side Rail (4), by using Bolts (C), Lock Washer (D), Flat Washer (E) with M4 Allen Key (K).

Fixez le rail de support (8) au rail latéral (3) et au rail latéral (4), à l'aide des boulons (C), de la rondelle frein (D) et de la rondelle plate (E), en utilisant la clé Allen M4 (K).

Step 4 / Étape 4

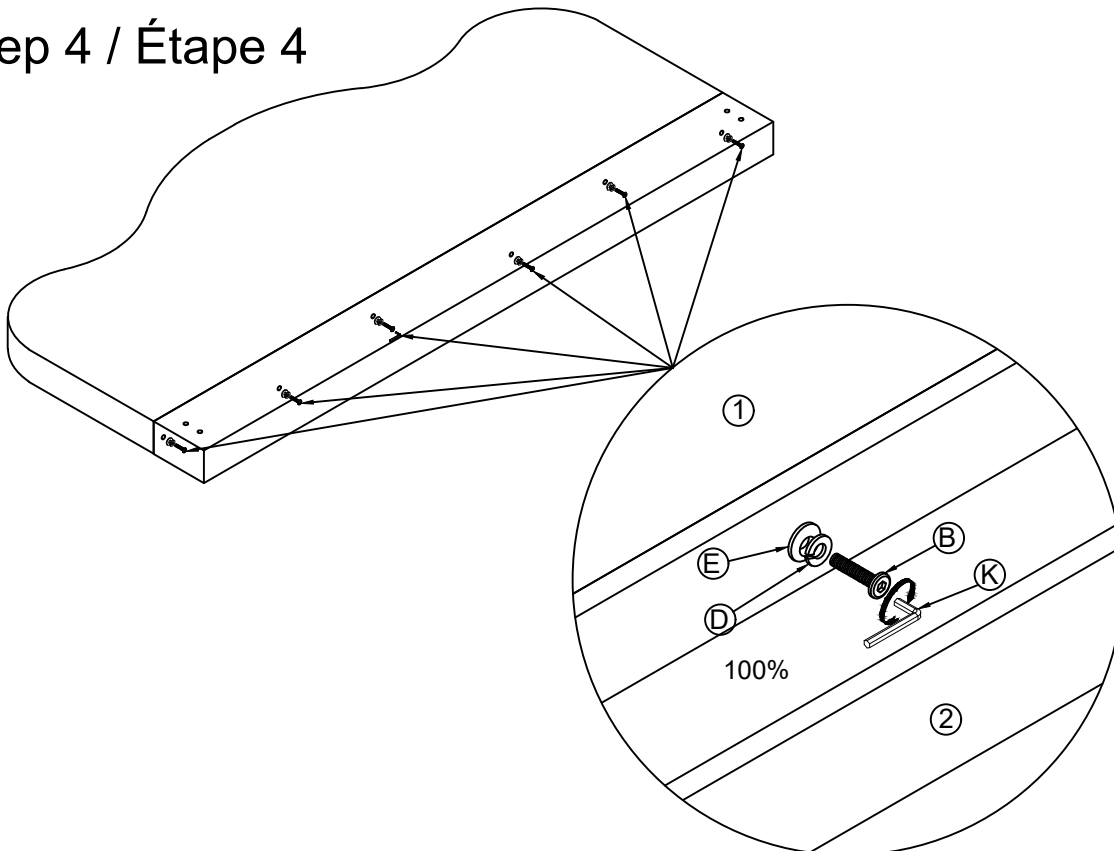

B x6 pcs
5/16"x30mm

D x6 pcs
5/16"

E x6 pcs
5/16"





K M4 100%

Attach the Headboard (1) to the Headboard Storage (2) by using Bolts (B), Lock Washer (D) and the Flat Washer (E) with M4 Allen Key (K).

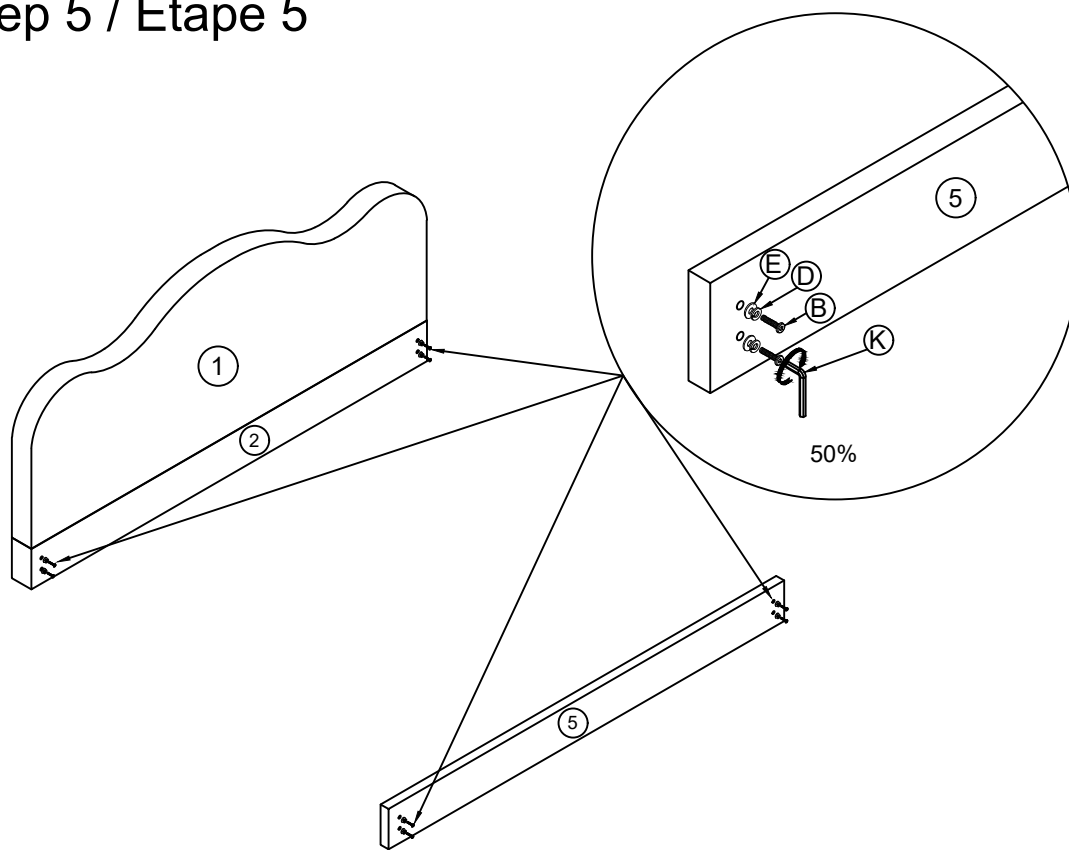
Fixez la Tête De Lit (1) à la Tête De Lit Avec Rangement (2) en utilisant les Boulons (B), la Rondelle frein (D) et la Rondelle plate (E) avec la Clé Allen (K).

Step 5 / Étape 5



B		x8 pcs
5/16"x30mm		
D		x8 pcs
5/16"		
E		x8 pcs
5/16"		
K		50%
M4		

Use Bolts (B), Lock Washer (D) and Flat Washer (E) with Allen Key (K) to screw into the Headboard Storage(2) and Footboard (5) to connect Side Rails.

Utilisez les Boulons (B), la Rondelle frein (D) et la Rondelle plate (E) avec la Clé Allen (K) pour visser dans la Tête De Lit Avec Rangement (2) et le Pied De Lit (5) afin de connecter les Lattes Latérales

Step 6 / Étape 6

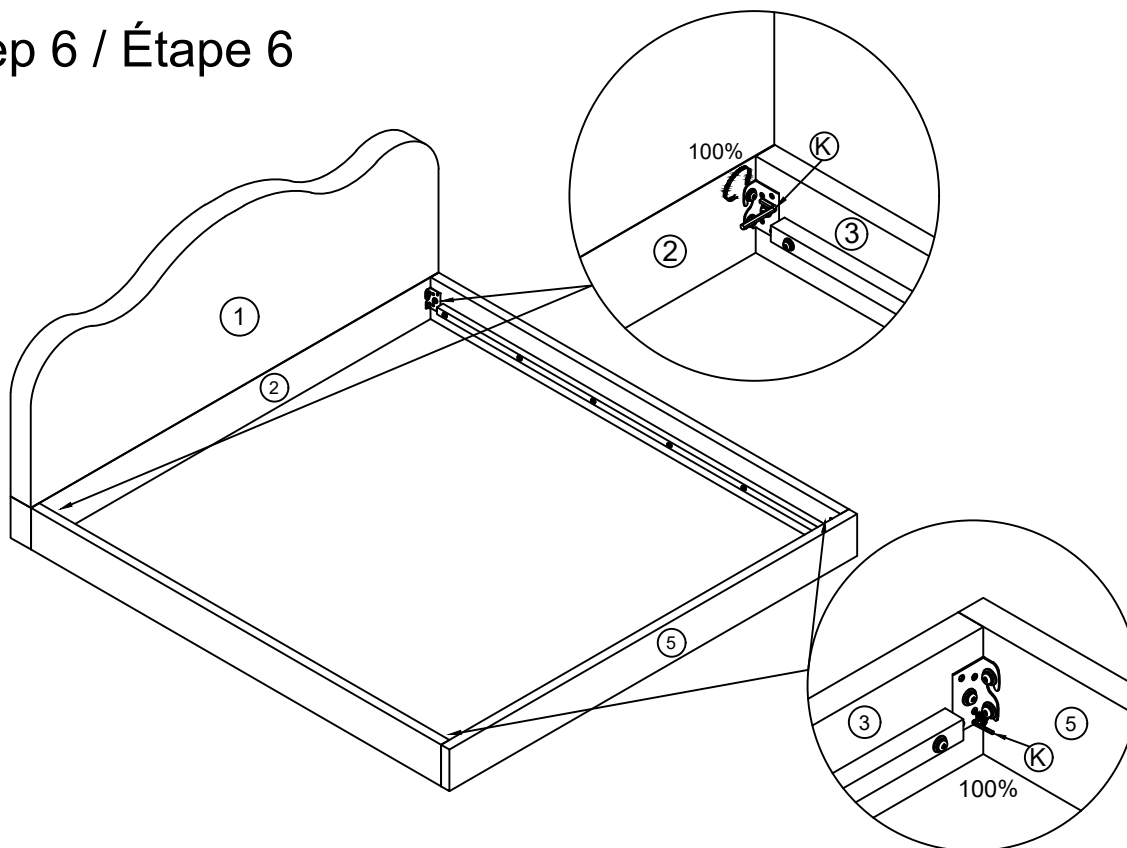

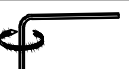
K		100%
M4		

Attach the Side Rail Right (3) and the Side Rail Left (4) to the Headboard Storage(2) and Footboard (5) by using M4 Allen Key (K) to tighten Bolts (B).

Fixez le Rail Latéral Droit (3) et le Rail Latéral Gauche (4) à la Tête De Lit Avec Rangement (2) et au Pied De Lit (5) en utilisant la Clé Allen (K) pour serrer les Boulons (B).

Step 7 / Étape 7

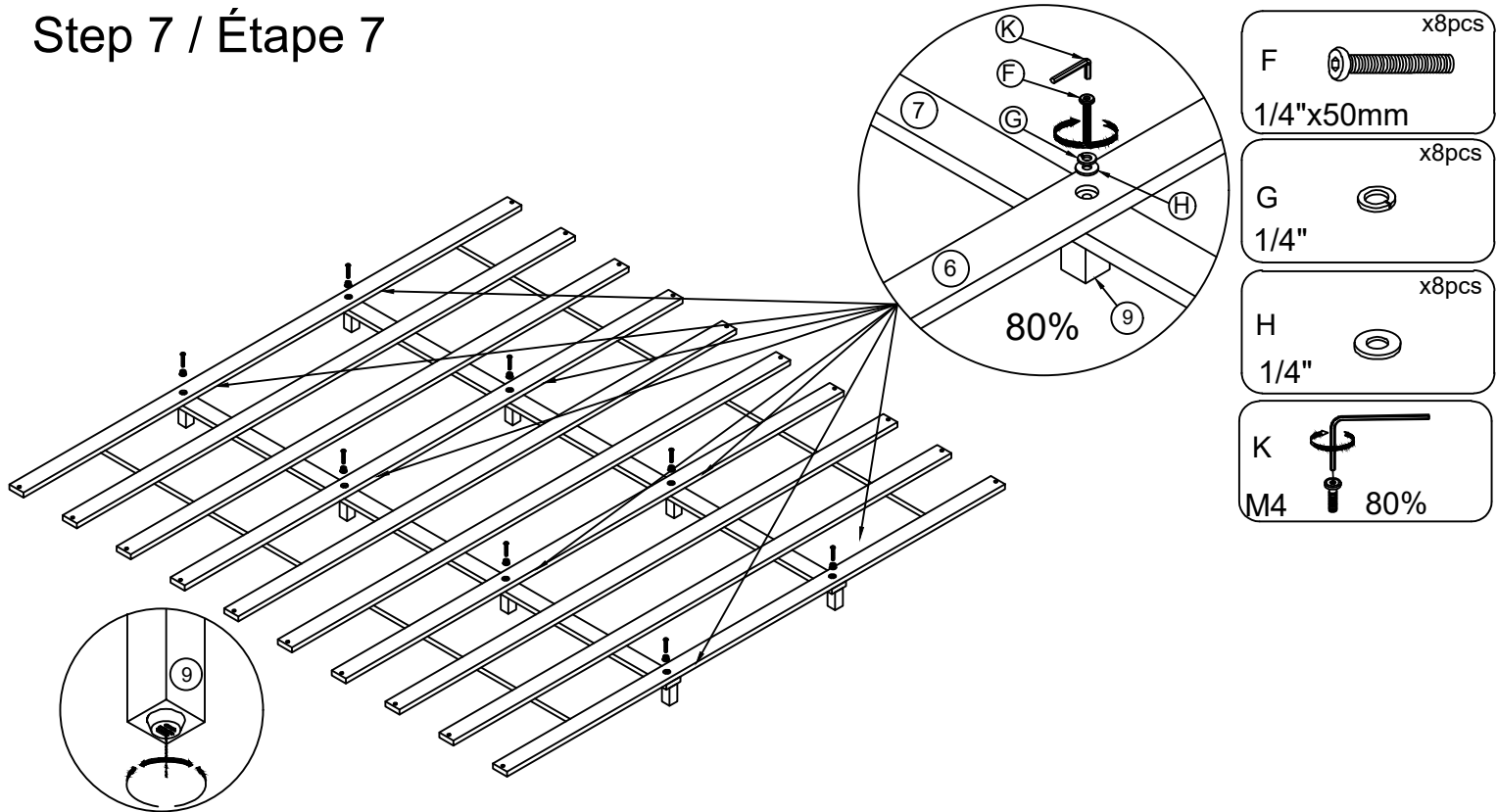

Attach the Slats (6) and the Middle Support Bar (7) together through the 4 pre-drilled holes by Bolts (F), Lock Washer (G) and Flat Washer (H) with Allen Key (K).

Fixez les Lattes (6) et la Barre Centrale De Lit (7) ensemble à travers les 4 trous pré-perçés en utilisant les Boulons (F), la Rondelle frein (G) et la Rondelle plate (H) avec la Clé Allen (K).

Step 8 / Étape 8

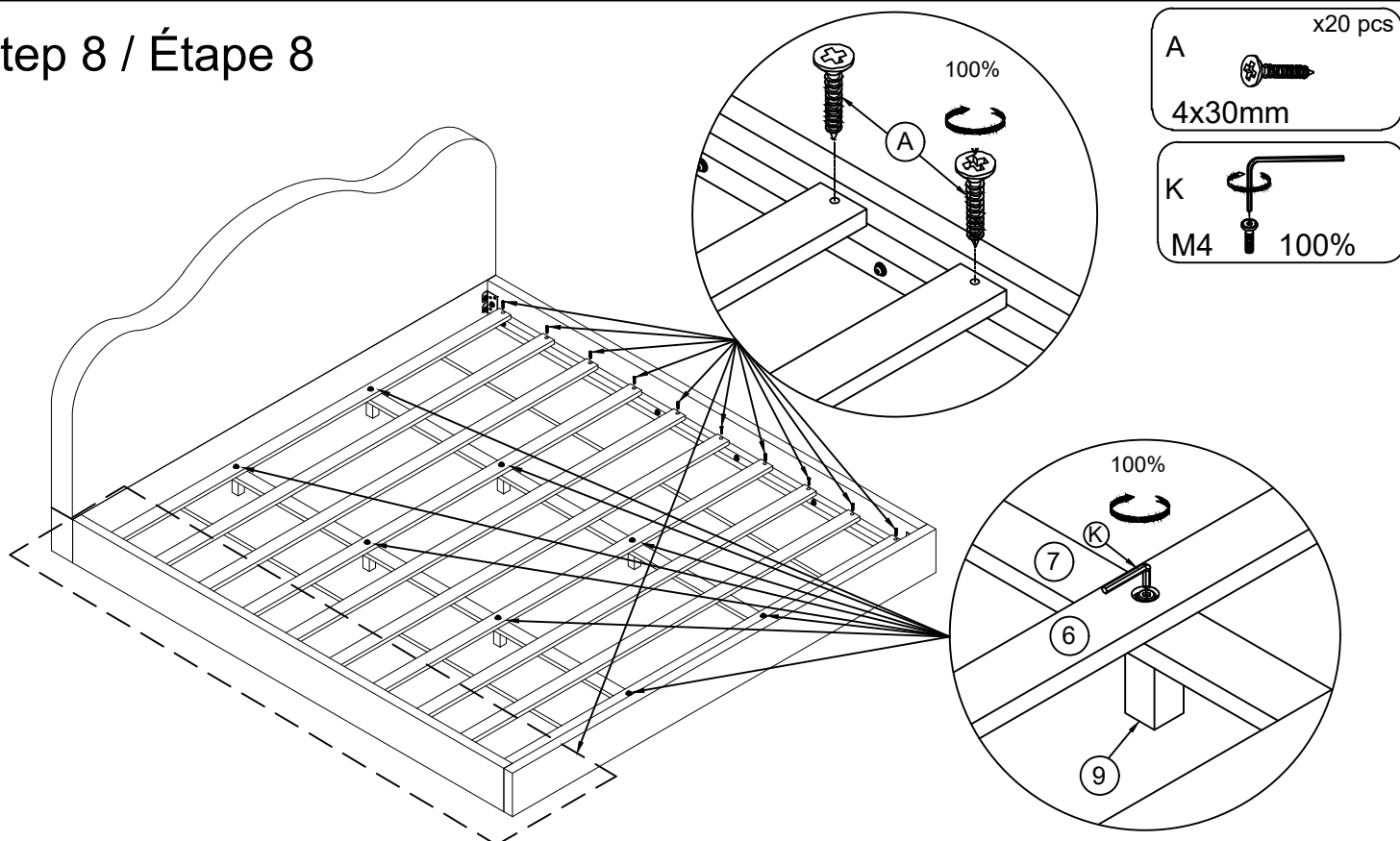

Attach the Slats (6) with 2 pre-holes to the Side Rail Right (3) and the Side Rail Left (4) with Screw (A). Finally, use the M4 Allen Key (K) to tighten Bolts (F) 100%. Adjustable leveling foot of Center Support Legs.
Fixez les Lattes (6) avec 2 trous pré-perçés au Rail Latéral Droit (3) et au Rail Latéral Gauche (4) avec les Vis (A). Enfin, utilisez la Clé Allen (K) pour serrer à 100% les Boulons (F). Pied réglable des Pieds de Support Centrale.

Finish / Terminé

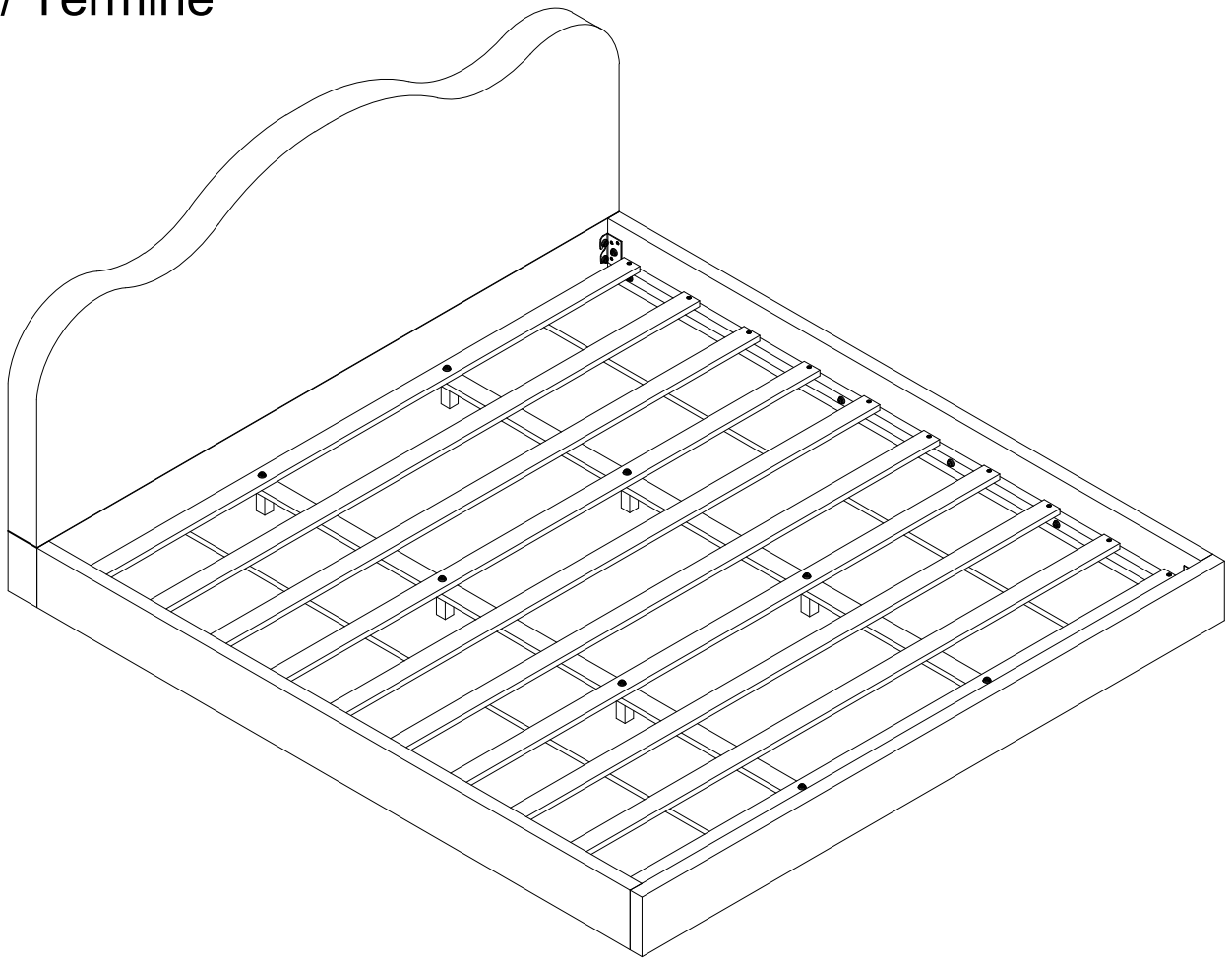

Attention

Place the Bed on a LEVEL SURFACE. / Placez le lit sur une surface plane et stable.
Inspect it and make sure all parts are adequately connected.
Inspectez-le et assurez-vous que toutes les pièces sont correctement connectées.
Don't push too hard, shake on the bed. / Ne poussez pas trop fort et ne secouez pas le lit.
This would help to align all the parts at the joint areas.
Cela aidera à aligner toutes les pièces aux zones de jonction.

CAUTION 1: When tightening these screws, tighten sequentially.
ATTENTION 1: Lors du serrage de ces vis, serrez-les dans l'ordre.

DO NOT tighten any screws fully and then towards the next one.
NE serrez aucune vis complètement avant de passer à la suivante.
This would cause the frame to warp. / Cela pourrait provoquer une déformation du cadre.
If there is still wobbles, loosen the screws and execute this same process.

S'il y a encore des oscillations, desserrez les vis et répétez ce même processus.

DO NOT tighten any screws fully and then towards the next one.

NE serrez aucune vis complètement avant de passer à la suivante.

WARNING: IF BED IS NOT STABLE, IT COULD LEAD TO DAMAGING THE PRODUCT.
AVERTISSEMENT: SI LE LIT N'EST PAS STABLE, IL POURRAIT ENDOMMAGER LE PRODUIT.

Ensure all screws are fully locked into position.

Assurez-vous que toutes les vis sont complètement verrouillées en position.

The bed is ready to be used. / Le lit est prêt à être utilisé.

CAUTION 2: This bed can only be used on a flat, level surface.

ATTENTION 2: Ce lit ne peut être utilisé que sur une surface plane et horizontale.