

Installation & Assembly

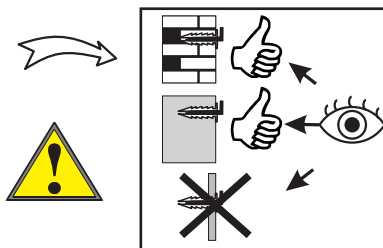

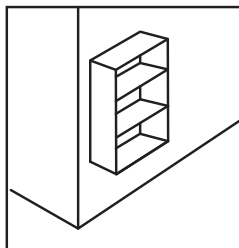
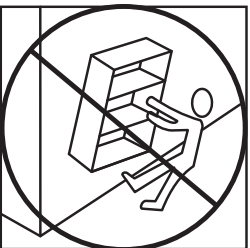
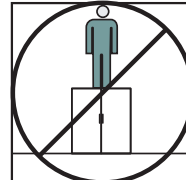
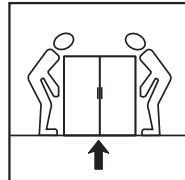
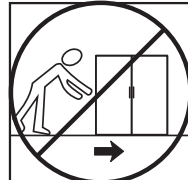
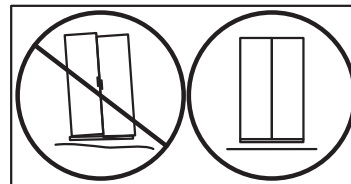
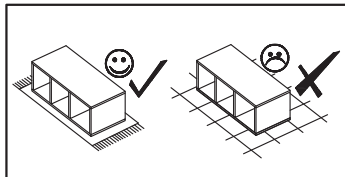
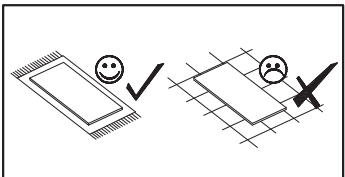
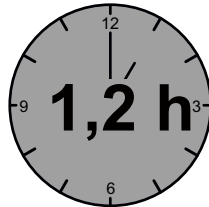
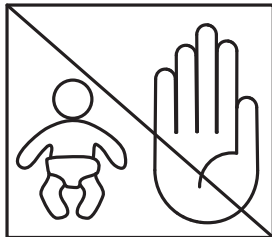
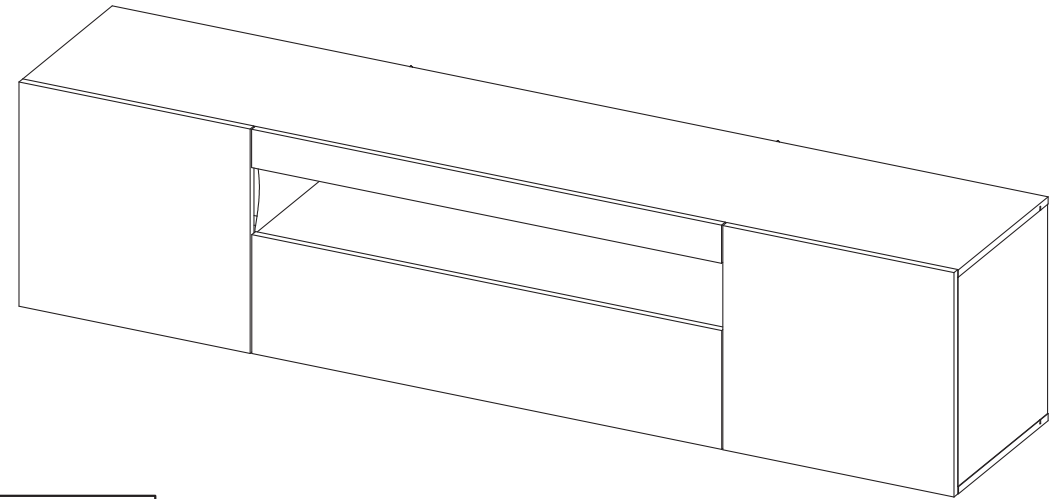
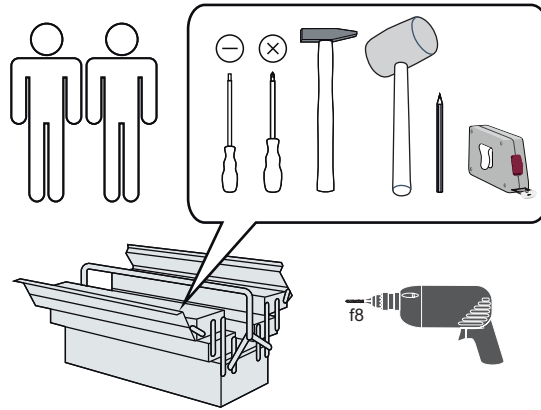
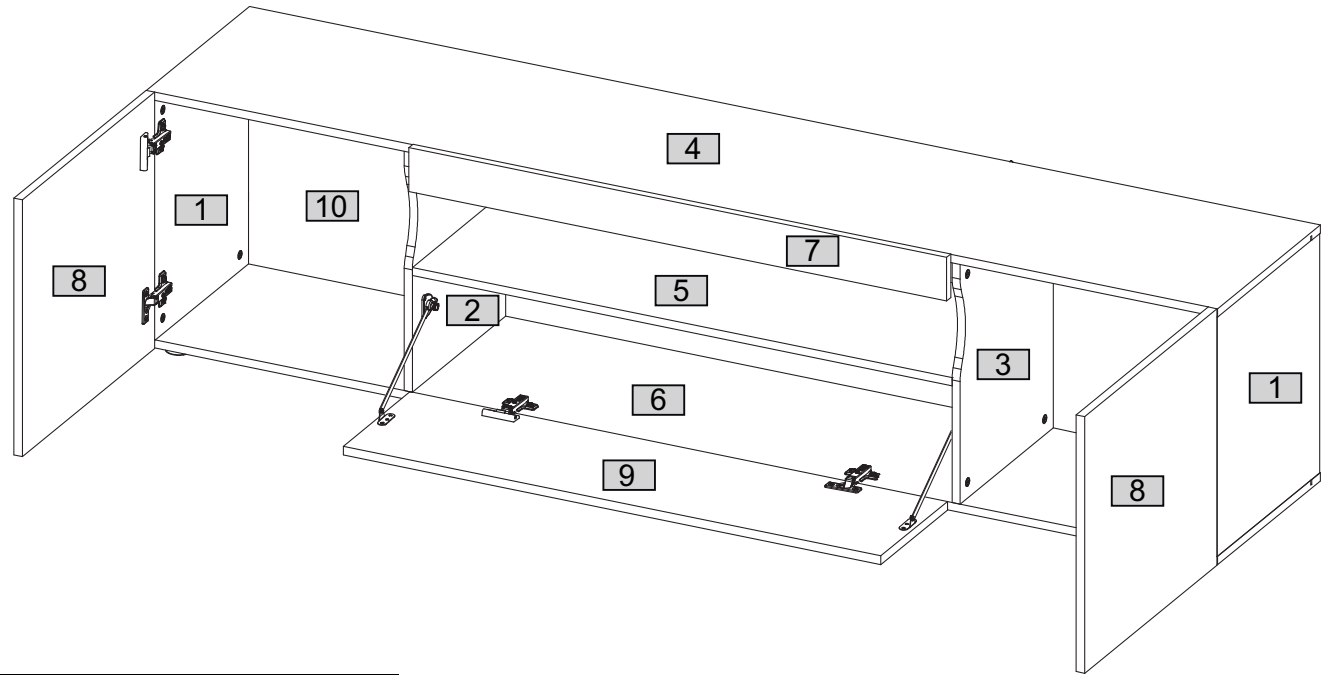
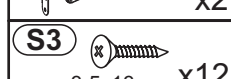
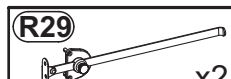
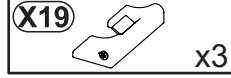
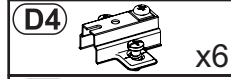
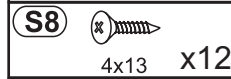
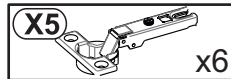
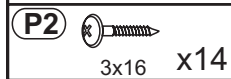
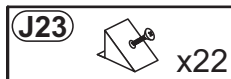
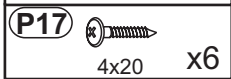
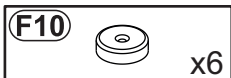
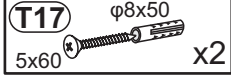
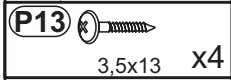
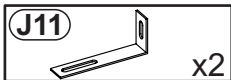
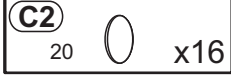
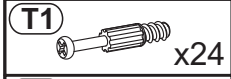
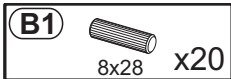

Nr	Ausmaß		St	Colli
1	439	383	15	2
2	439	348	15	1
3	439	348	15	1
4	2000	384	15	2
5	1008	348	15	2
6	2000	384	15	2
7	1004	80	16	2

Nr	Ausmaß		St	Colli
8	470	494	16	2
9	1004	249	16	2
10	1982	453	2	2



1

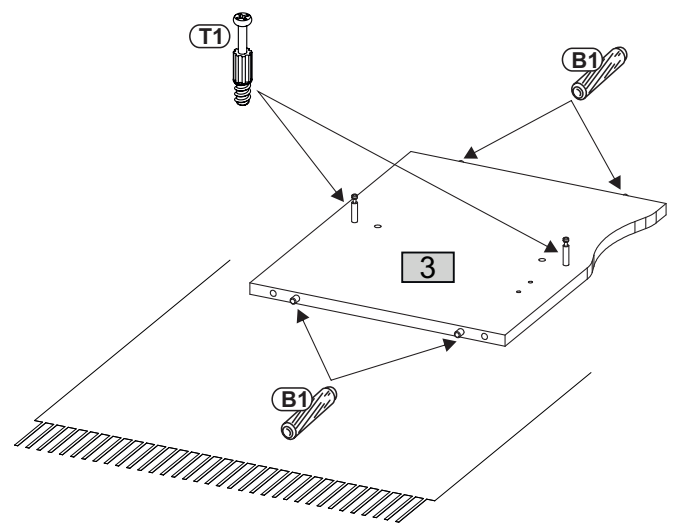
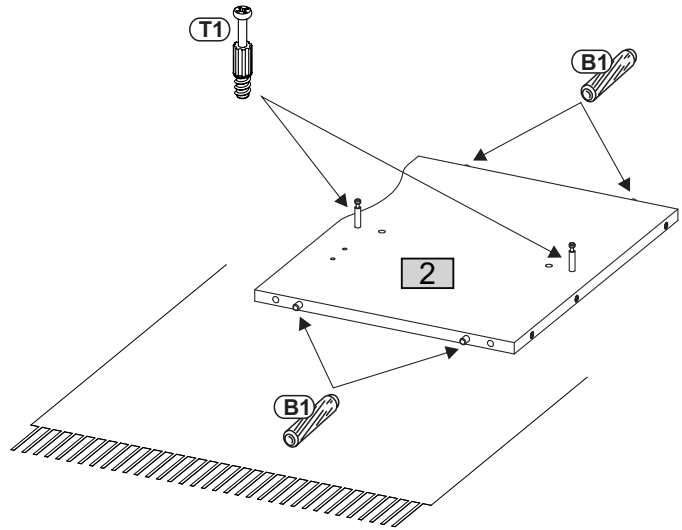
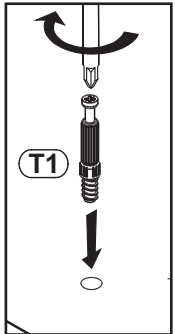
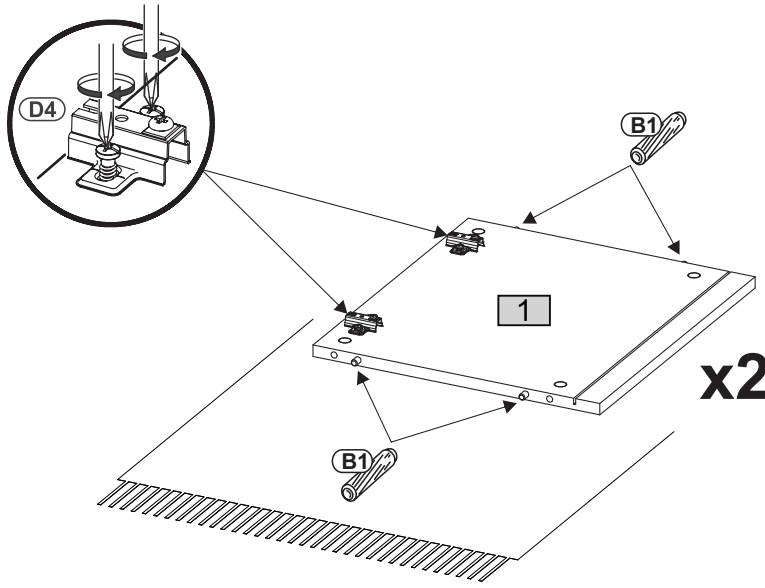
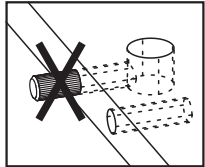
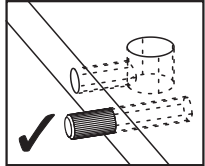
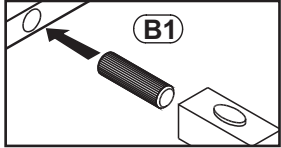
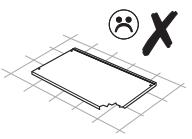
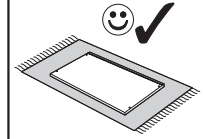
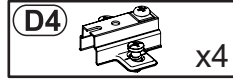
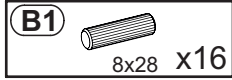
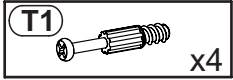

2

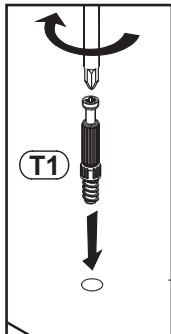
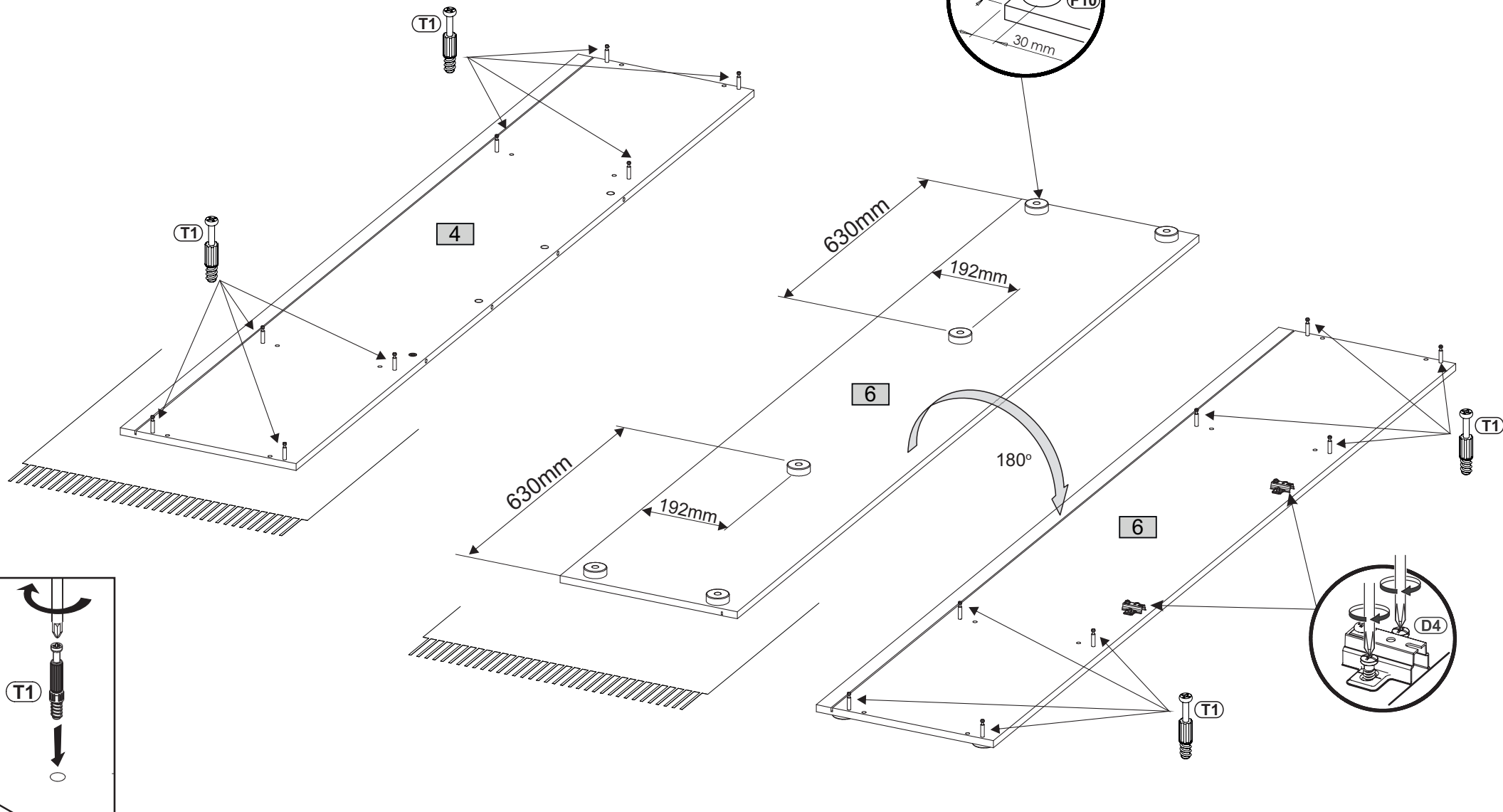
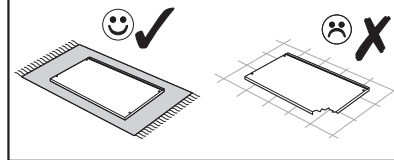
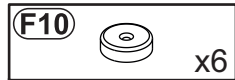
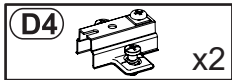
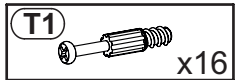

3

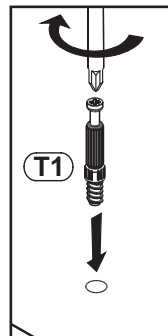
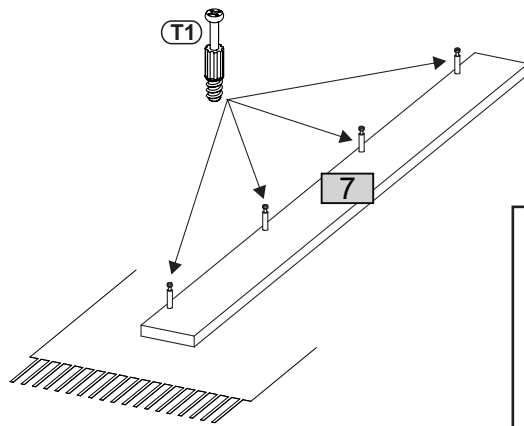
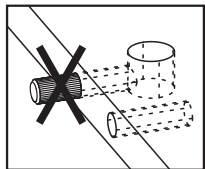
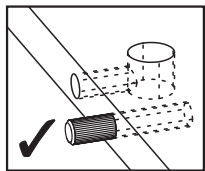
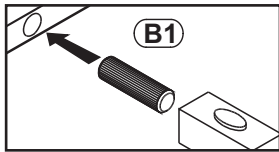
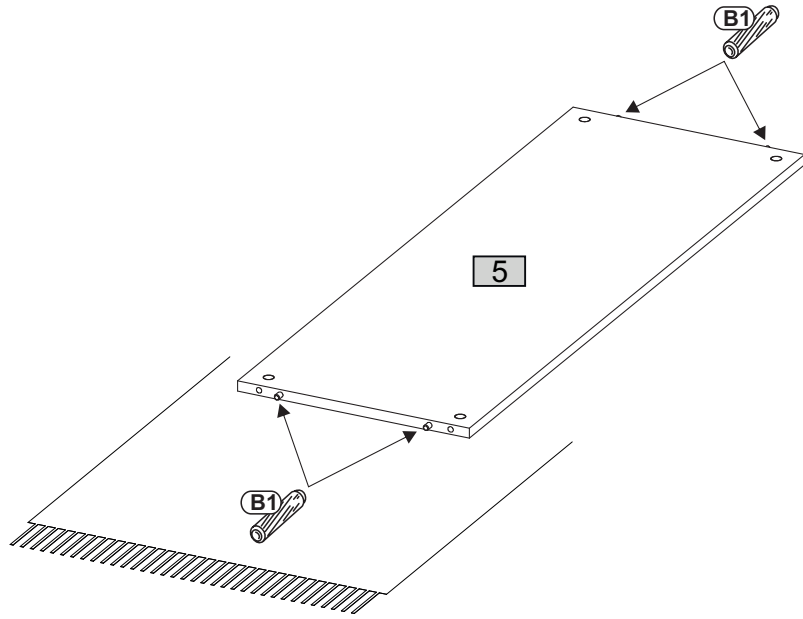
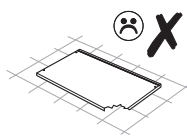
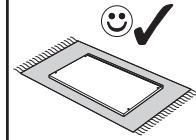
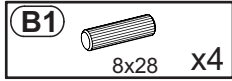
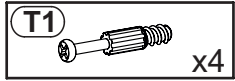

4

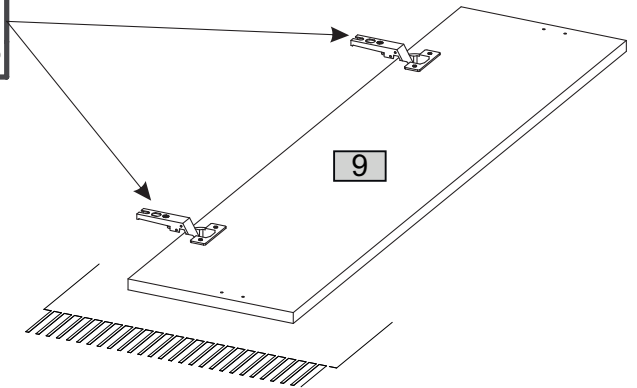
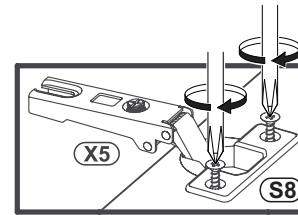
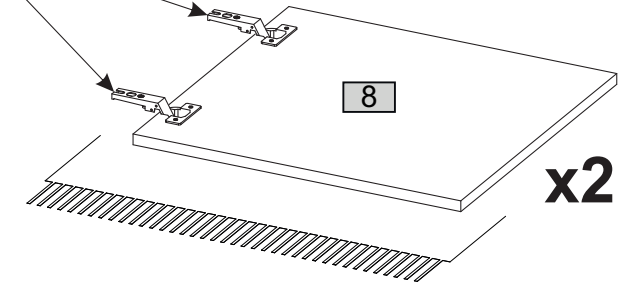
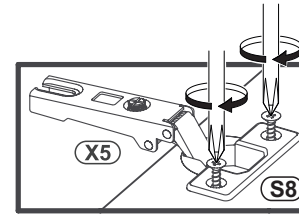
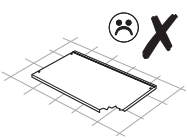
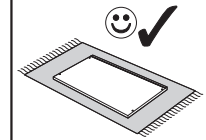
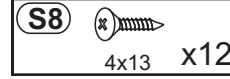
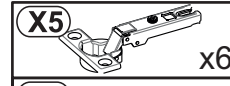

5

M1  x4

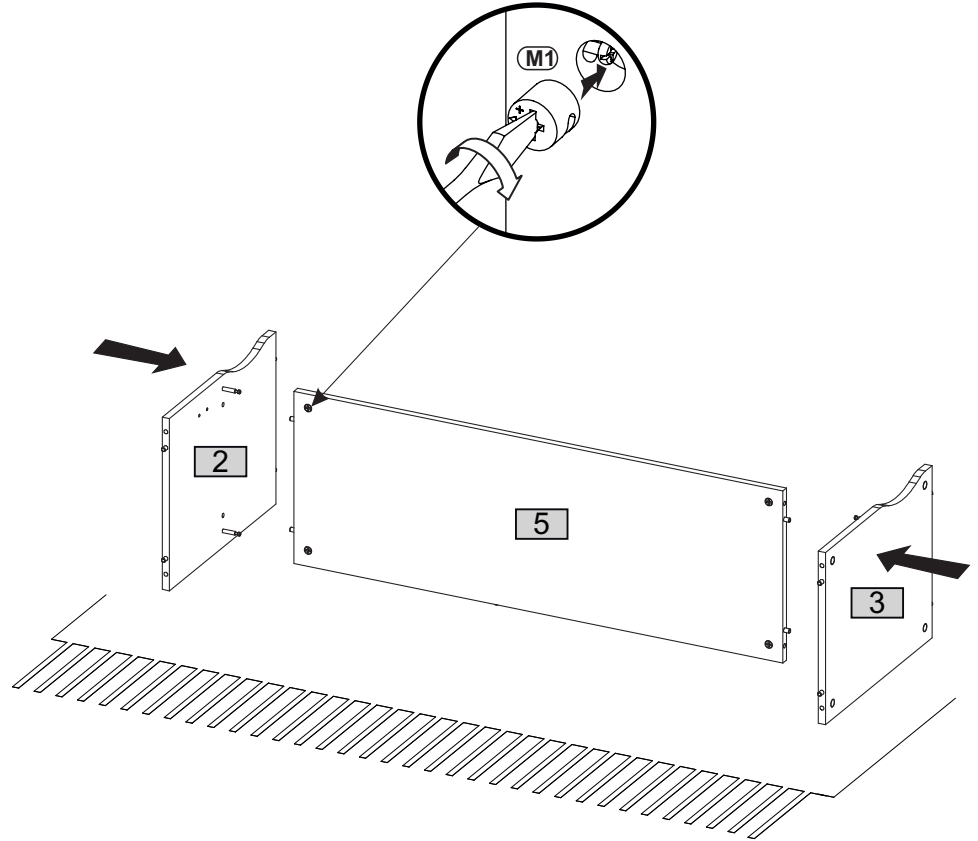
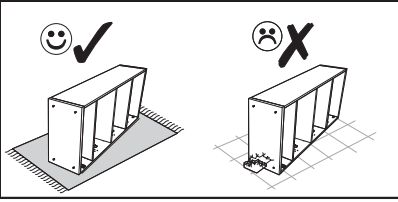

6

M1  x4

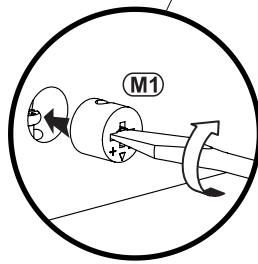
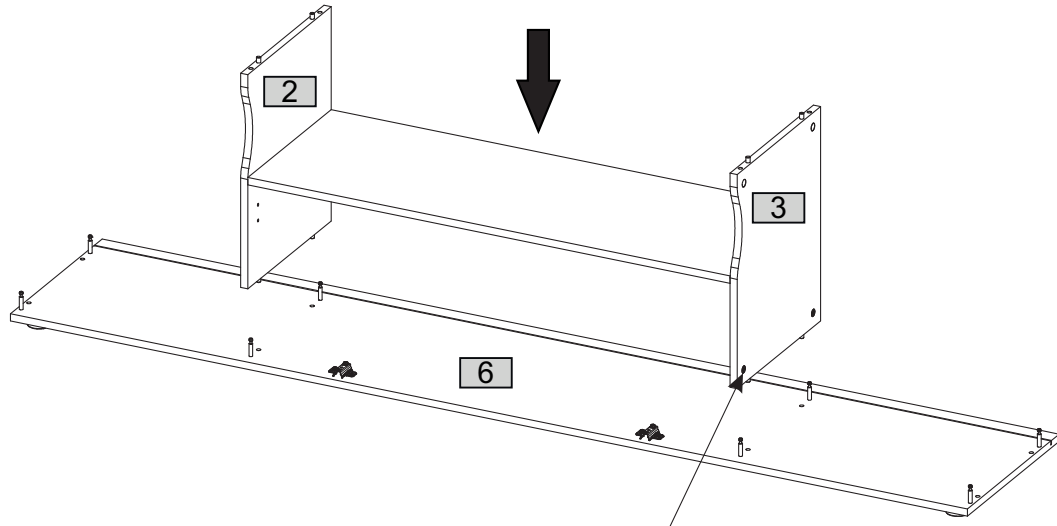

7

(M1)  x4

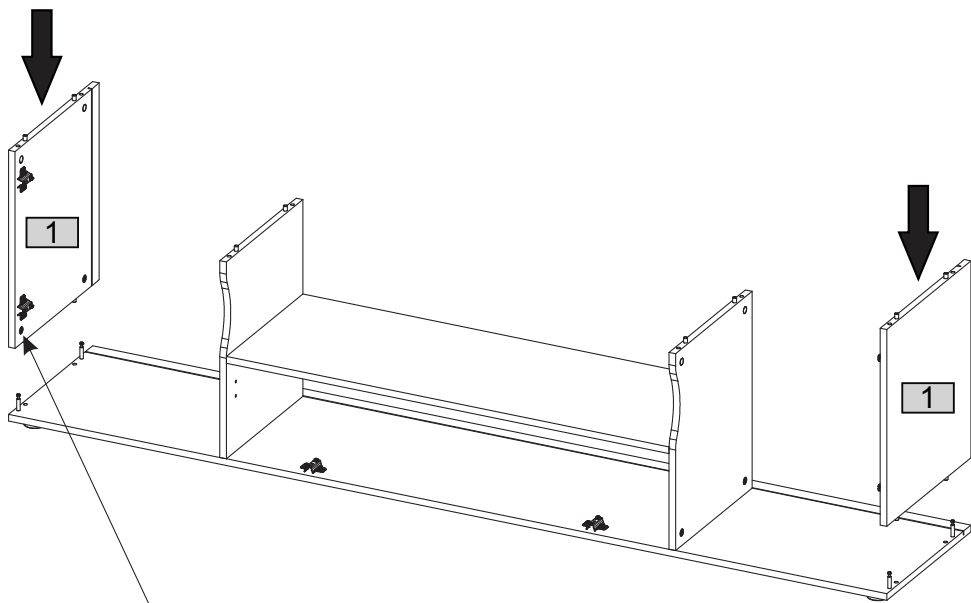

8

(M1)  x8

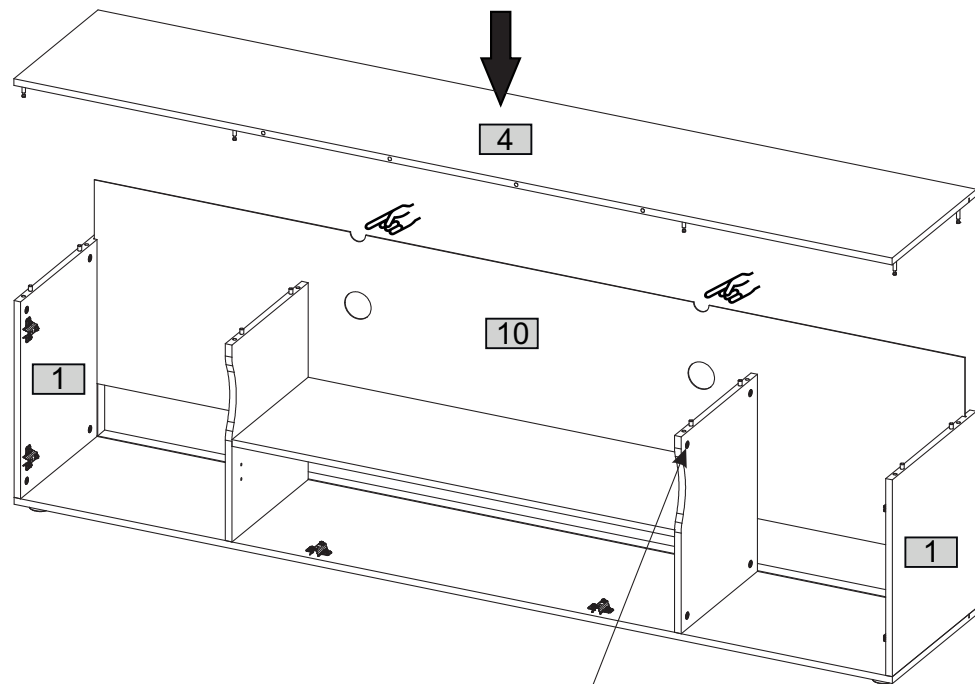

9

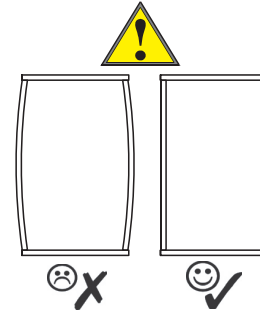
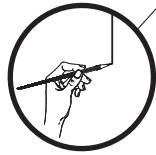
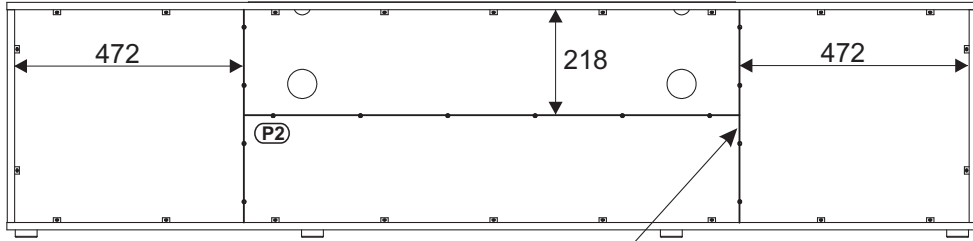
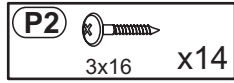
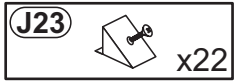

A=B

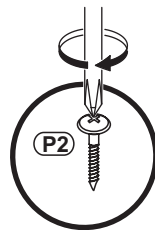
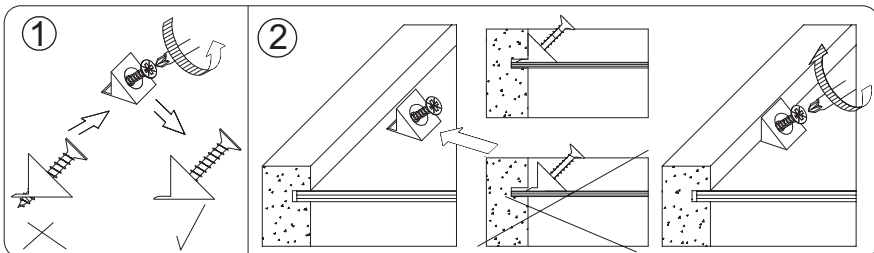
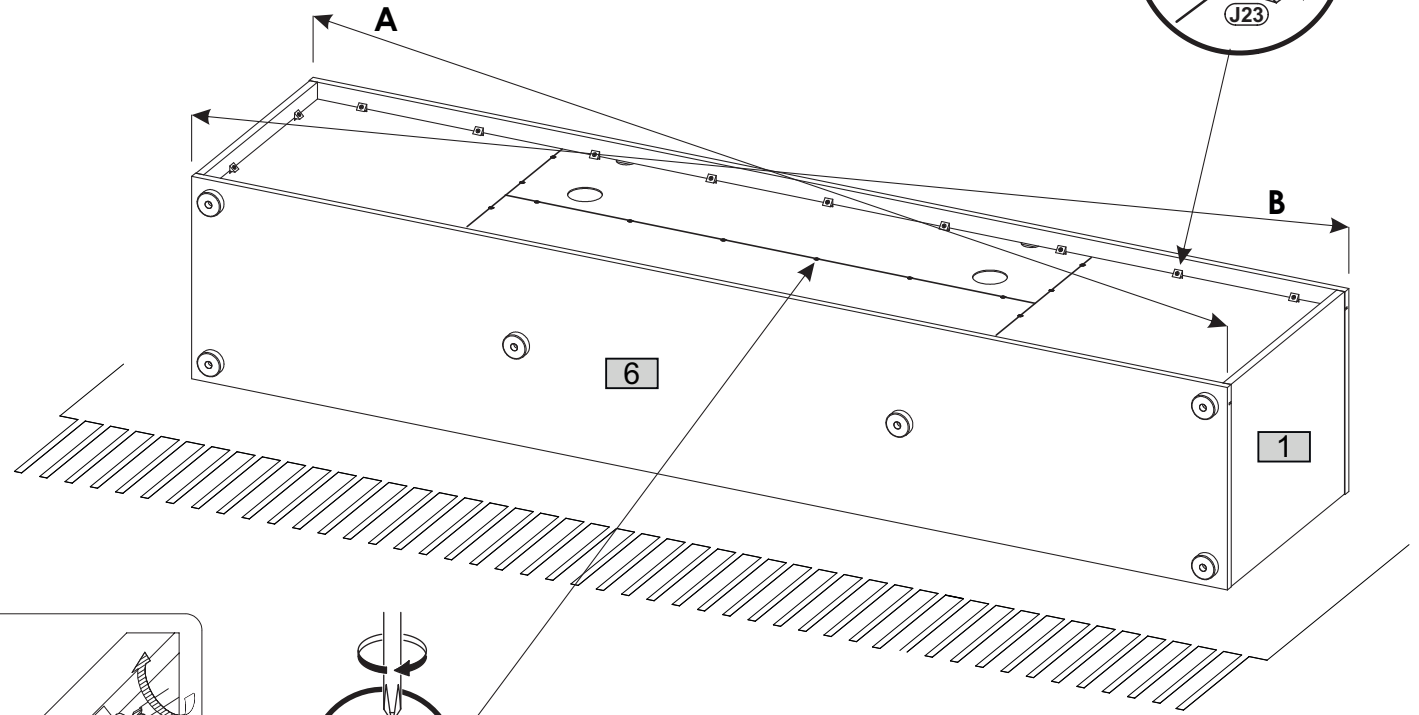
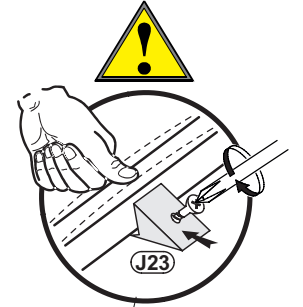
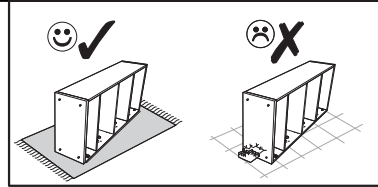

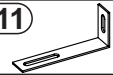
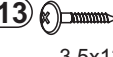
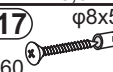

10

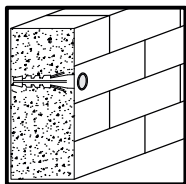
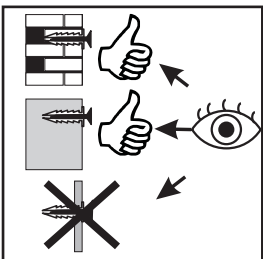
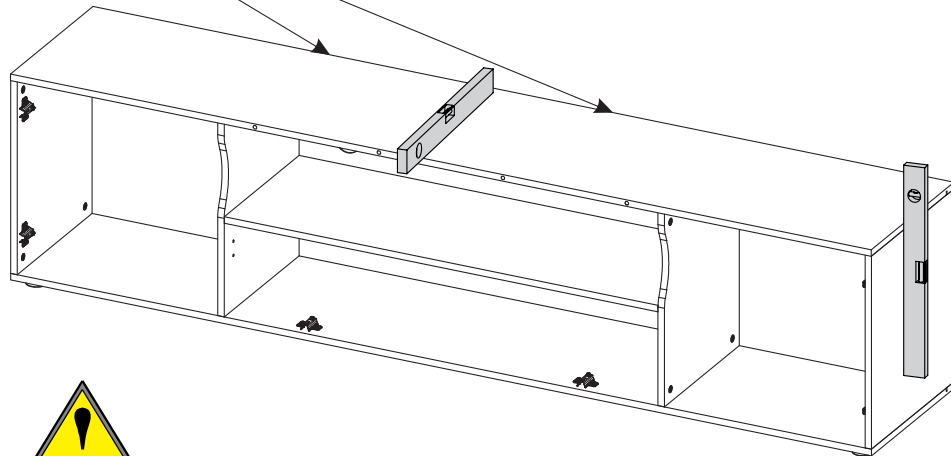
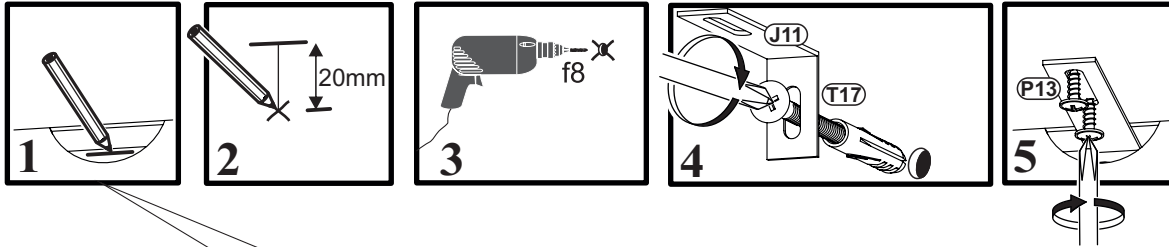
- J11**  x2
- P13**  x4
- T17**  $\phi 8 \times 50$ x2

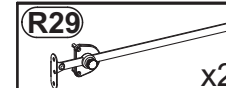

11

- M1**  x4
- R29**  x2
- S3**  x6

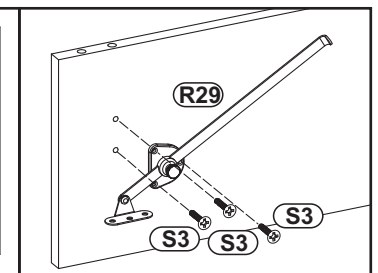
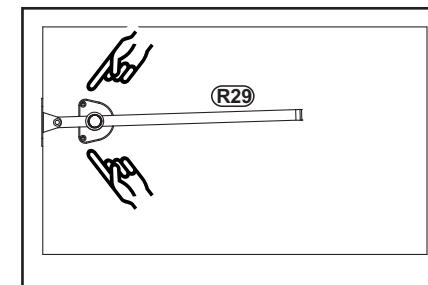
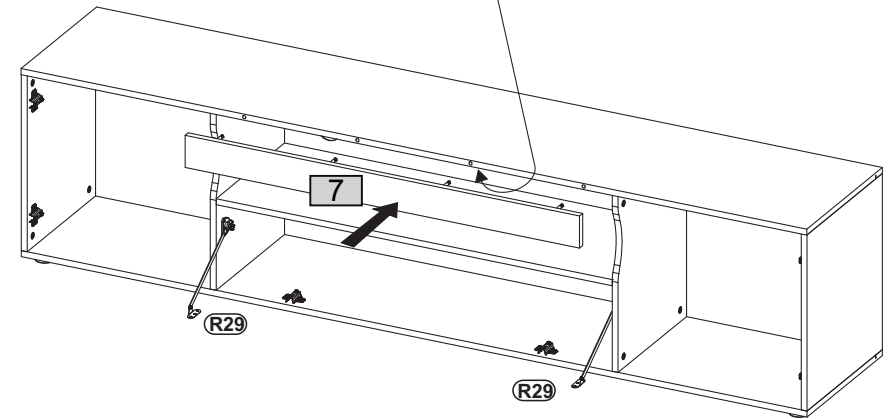
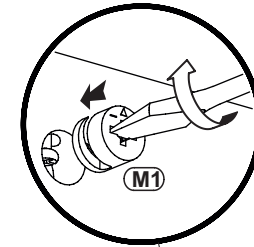

12

C2 20 x16

S3 3,5x13 x6

X19 x3

