

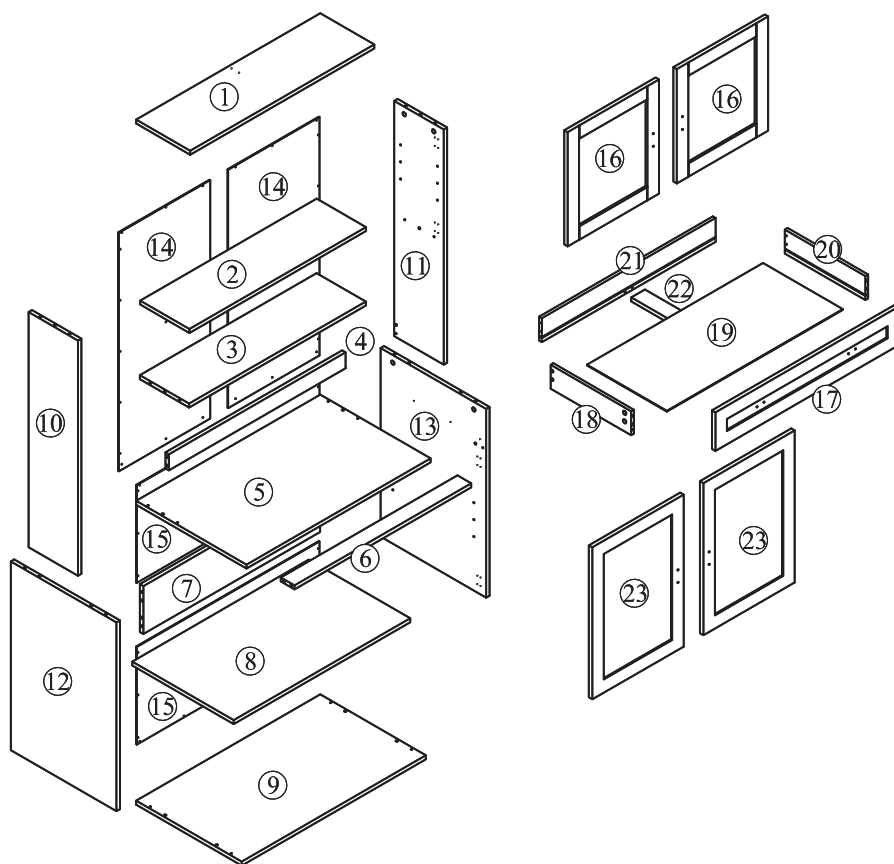

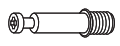







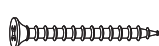

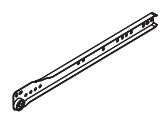
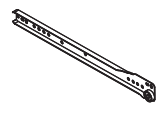
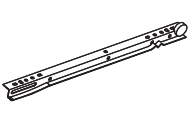
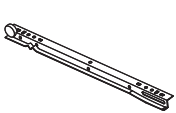

READ AND SAVE THIS INSTRUCTIONS FOR FUTURE USE

Tools Recommended





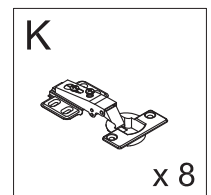
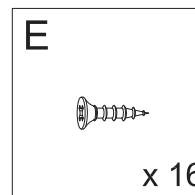
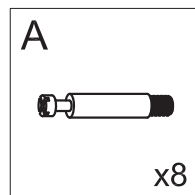
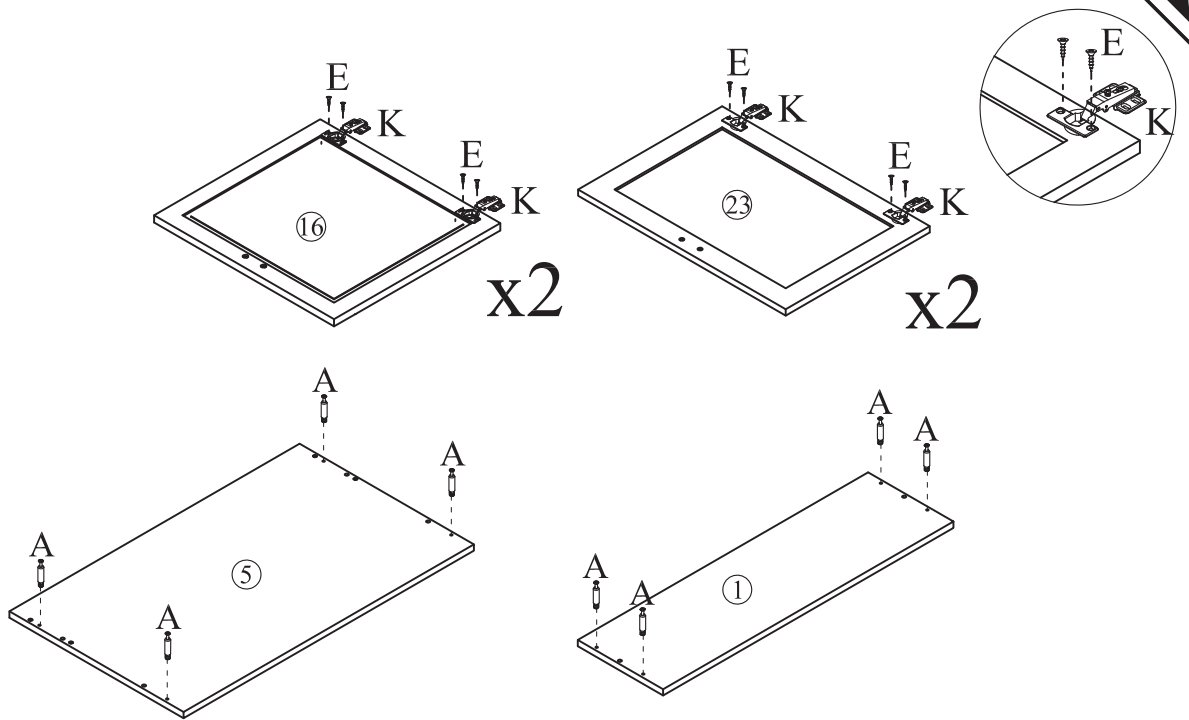
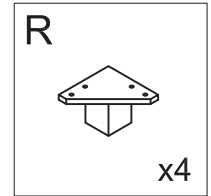
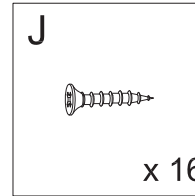
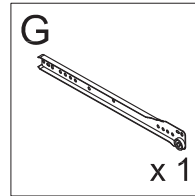
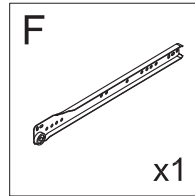
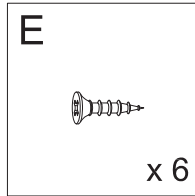
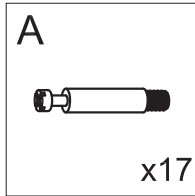
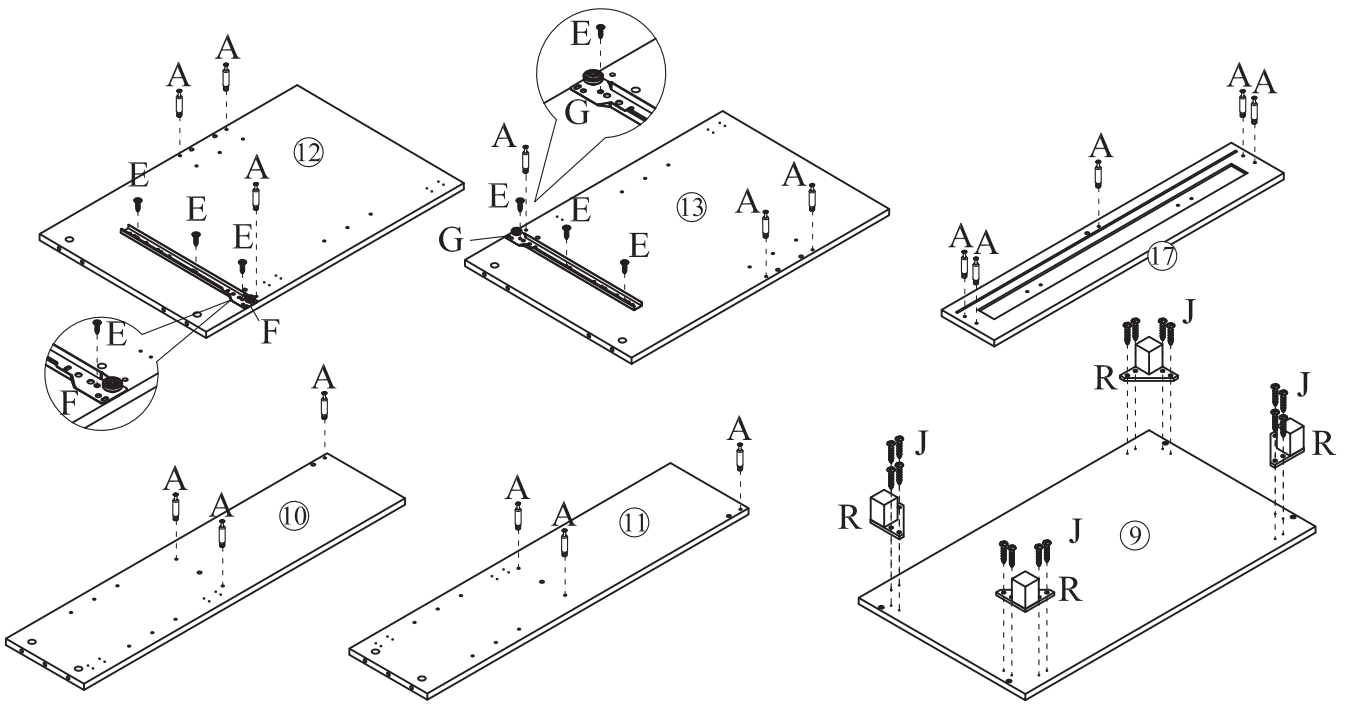

ASSEMBLY INSTRUCTION

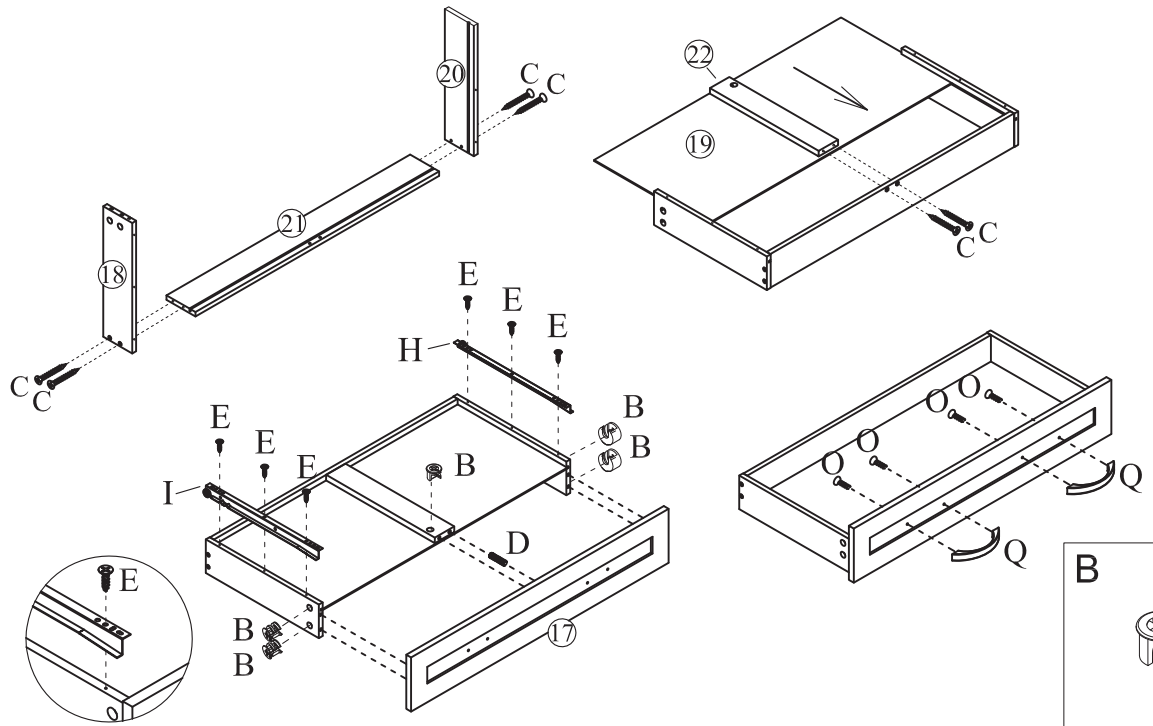

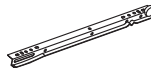

<p>A x 25</p>  <p>Φ6X35mm</p>	<p>B x 25</p>  <p>Φ15X9mm</p>	<p>C x 14</p>  <p>M4x35mm</p>	<p>D x 25</p>  <p>Φ8x30mm</p>	<p>E x 60</p>  <p>M3.5x12mm</p>
<p>F x 1</p> 	<p>G x 1</p> 	<p>H x 1</p> 	<p>I x 1</p> 	<p>J x 16</p>  <p>M4x16mm</p>
<p>K x 8</p> 	<p>L x 1</p> 	<p>M x 8</p> 	<p>N x 46</p>  <p>M3x12mm</p>	<p>O x 4</p>  <p>M5x14mm</p>
<p>P x 8</p>  <p>M5x25mm</p>	<p>Q x 6</p> 	<p>R x 4</p> 		



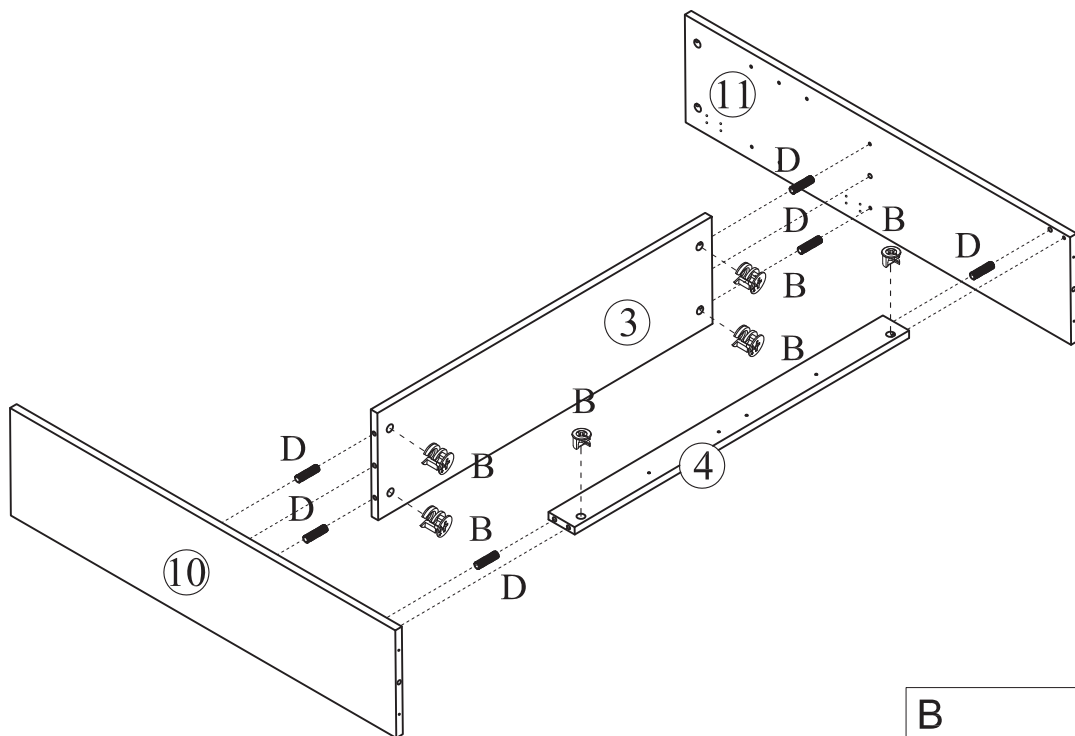

- | | | | | | | | |
|--------------------------------------------------------------------------------------------------------------|--------------------------------------------------------------------------------------------------------------|--------------------------------------------------------------------------------------------------------------|--------------------------------------------------------------------------------------------------------------|---------------------------------------------------------------------------------------------------------------|----------------------------------------------------------------------------------------------------------------|---------------------------------------------------------------------------------------------------------------|----------------------------------------------------------------------------------------------------------------|
| <p>C</p>  <p>x6</p> | <p>D</p>  <p>x1</p> | <p>E</p>  <p>x6</p> | <p>H</p>  <p>x1</p> | <p>I</p>  <p>x1</p> | <p>O</p>  <p>x4</p> | <p>B</p>  <p>x5</p> | <p>Q</p>  <p>x2</p> |
|--------------------------------------------------------------------------------------------------------------|--------------------------------------------------------------------------------------------------------------|--------------------------------------------------------------------------------------------------------------|--------------------------------------------------------------------------------------------------------------|---------------------------------------------------------------------------------------------------------------|----------------------------------------------------------------------------------------------------------------|---------------------------------------------------------------------------------------------------------------|----------------------------------------------------------------------------------------------------------------|



- | | |
|-----------------------------------------------------------------------------------------------------------------|-----------------------------------------------------------------------------------------------------------------|
| <p>B</p>  <p>x6</p> | <p>D</p>  <p>x6</p> |
|-----------------------------------------------------------------------------------------------------------------|-----------------------------------------------------------------------------------------------------------------|

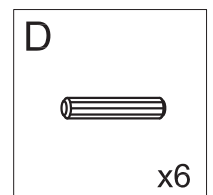
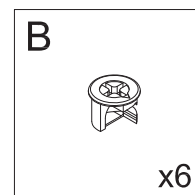
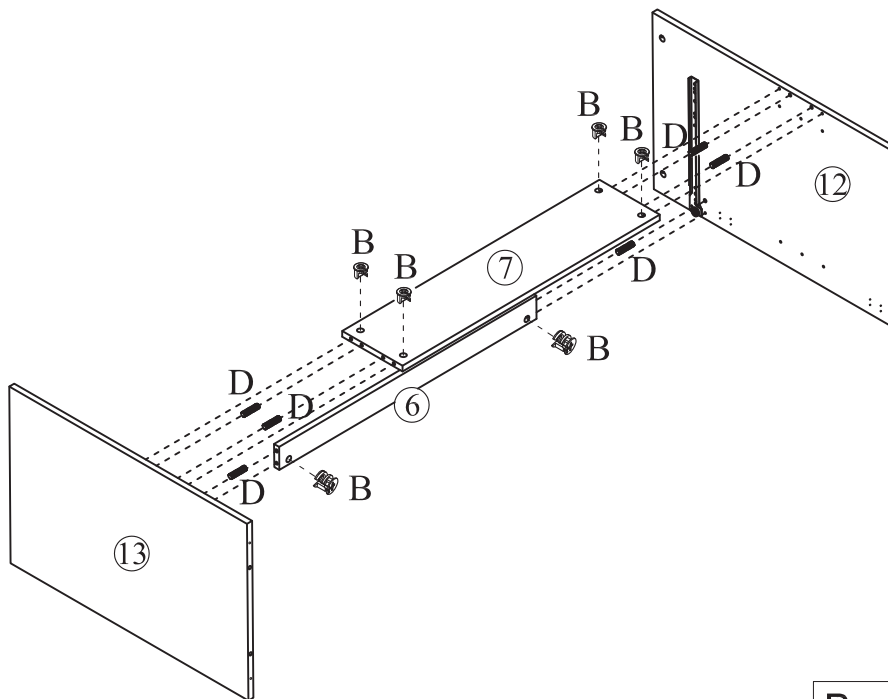
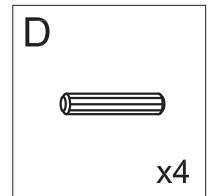
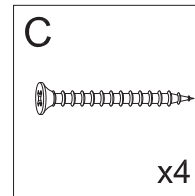
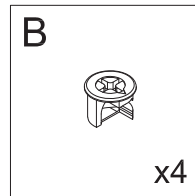
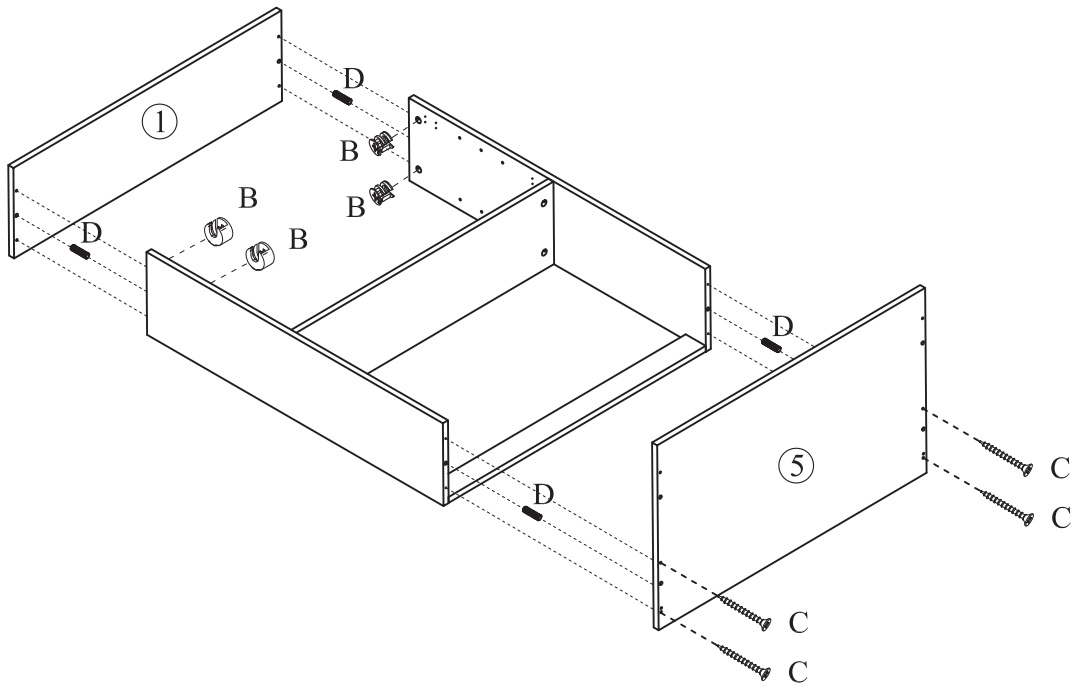

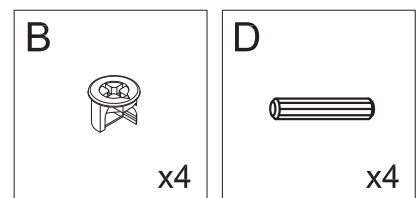
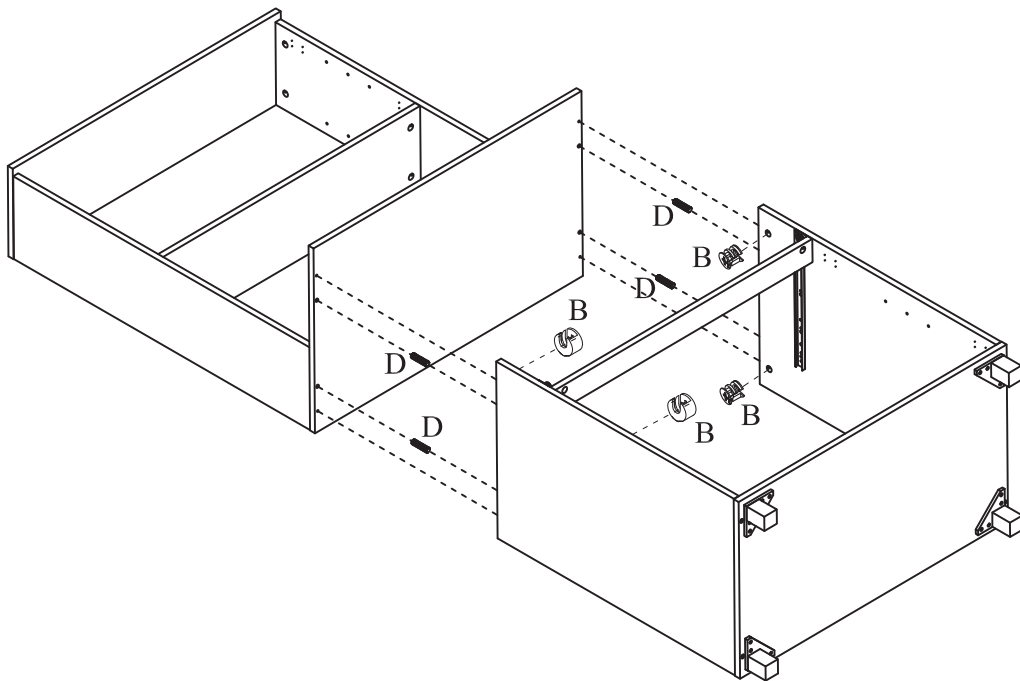
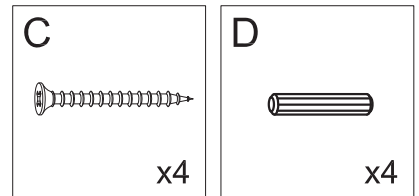
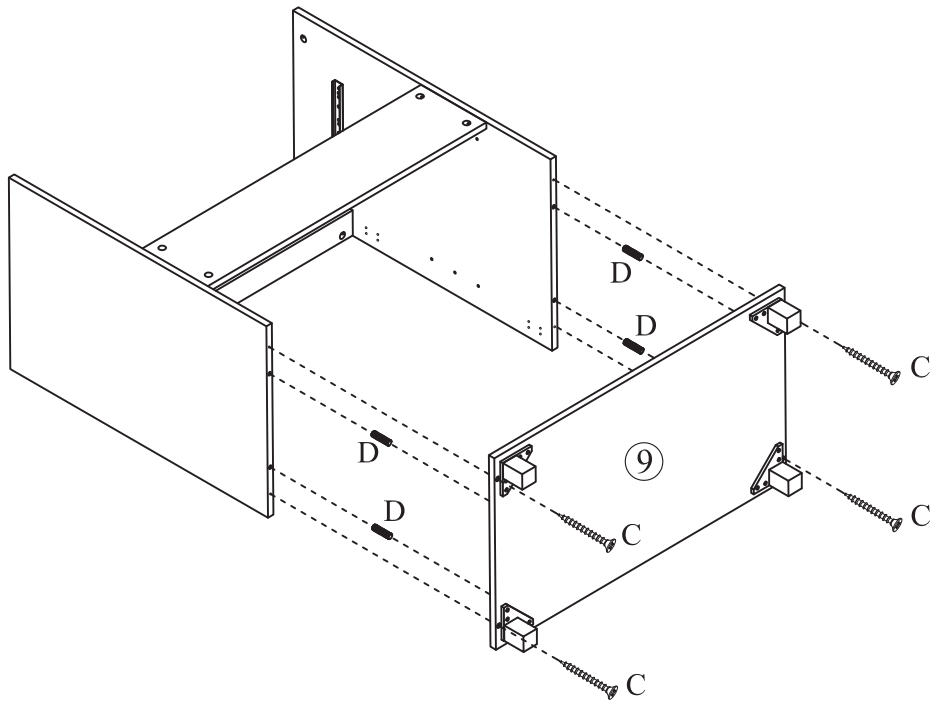

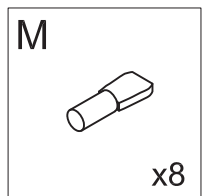
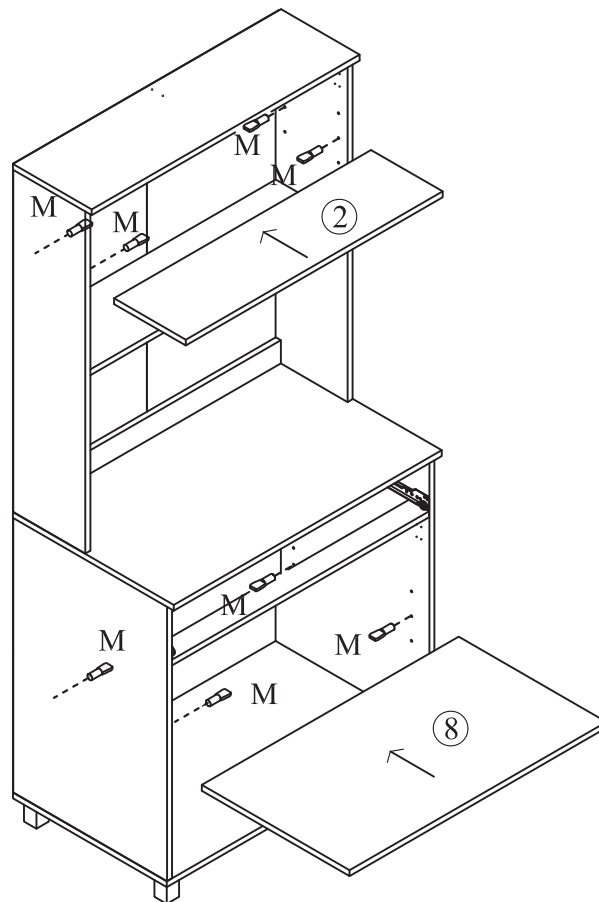
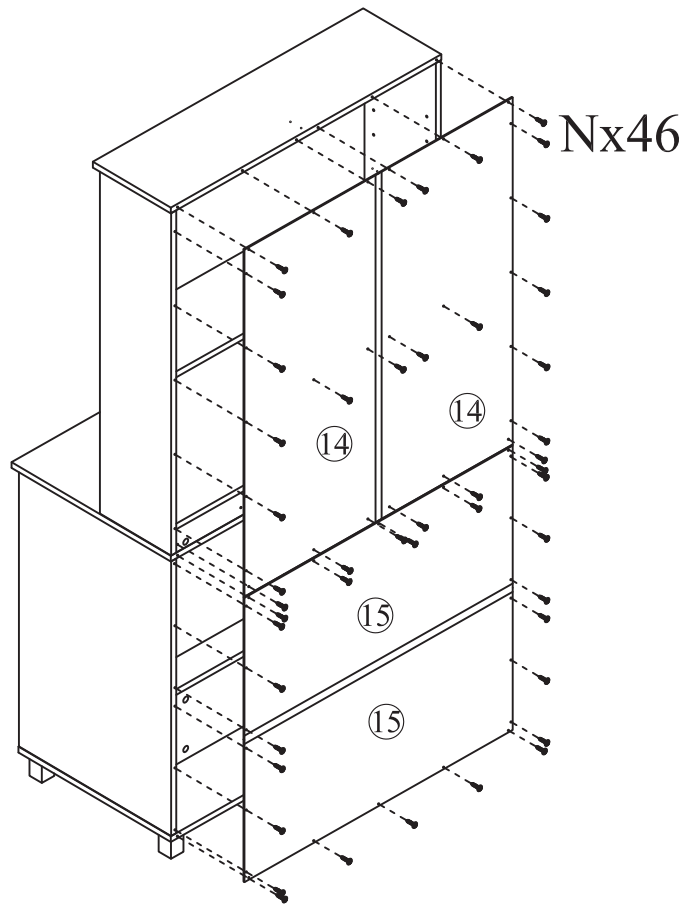

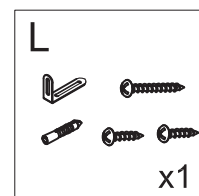
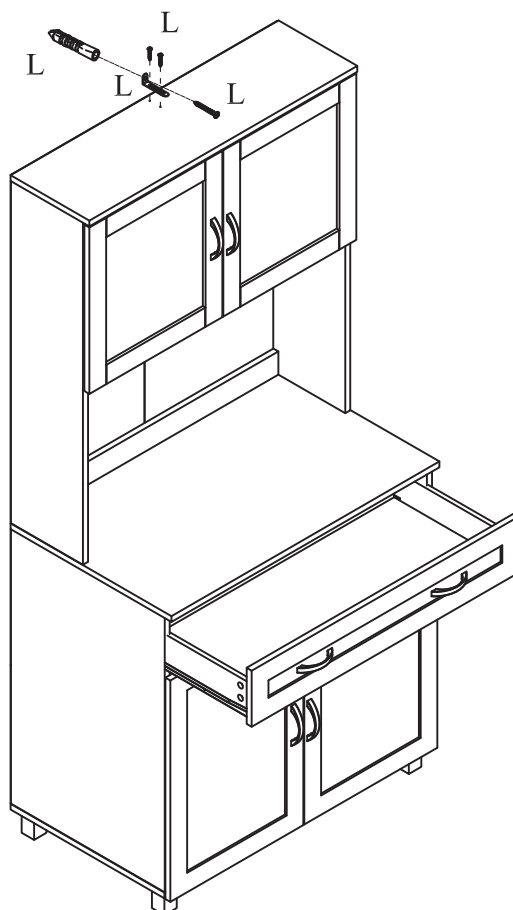
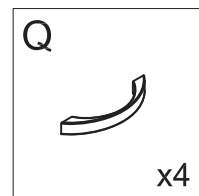
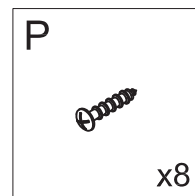
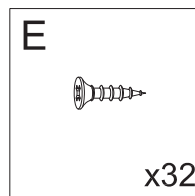
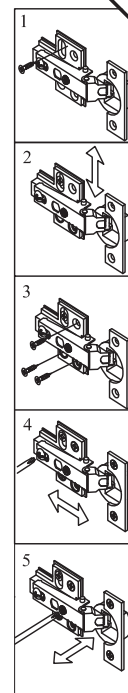
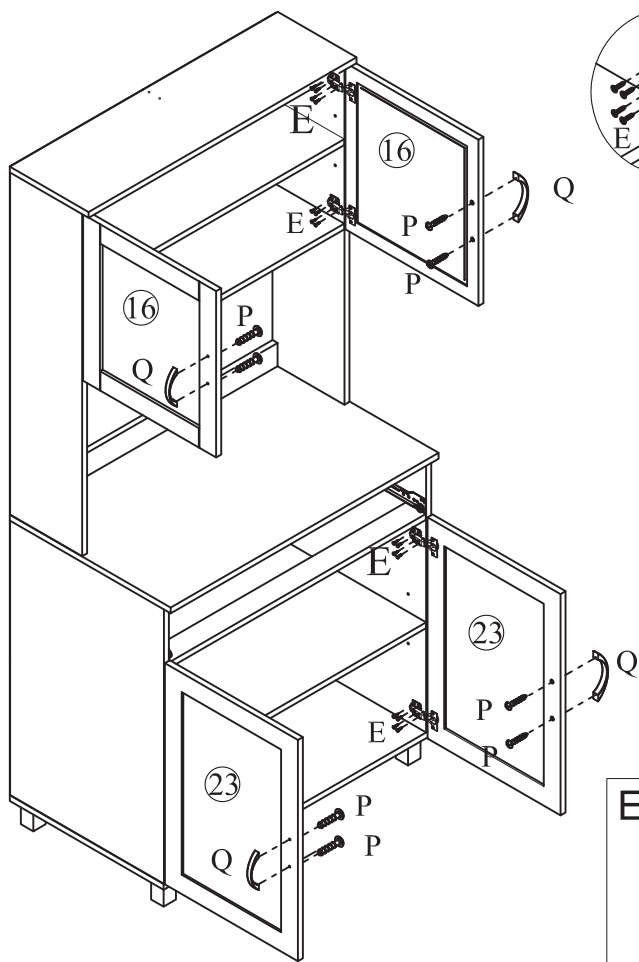



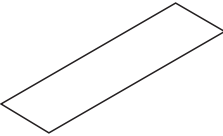
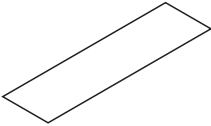
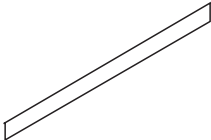
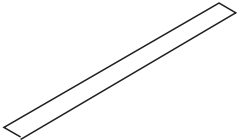
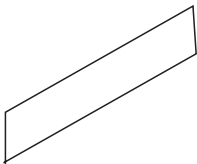
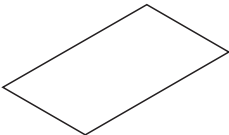



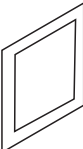

BOX-1/2

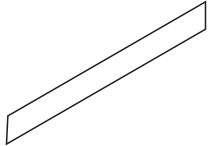
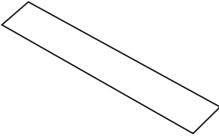
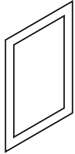
NO.	PARTS	QTY
2		1
3		1
4		1
6		1
7		1
8		1
10		1
11		1
14		2
16		2

BOX-1/2

NO.	PARTS	QTY
21		1
22		1
23		2
A ~ R		1

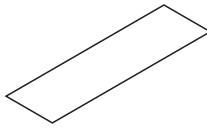
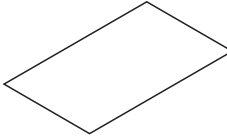
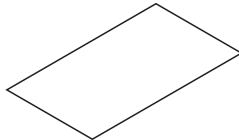
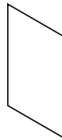
BOX-2/2

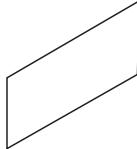
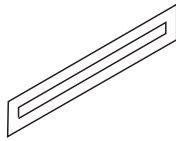
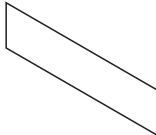
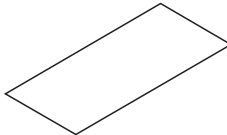
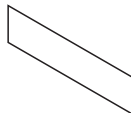
NO.	PARTS	QTY
1		1
5		1
9		1
12		1
13		1
15		1
17		1
18		1
19		1
20		1