



**USER'S MANUAL**  
**Full Size Iron Bed Frame**

THIS INSTRUCTION BOOKLET CONTAINS **IMPORTANT** SAFETY INFORMATION. PLEASE READ AND KEEP FOR FUTURE REFERENCE.

---



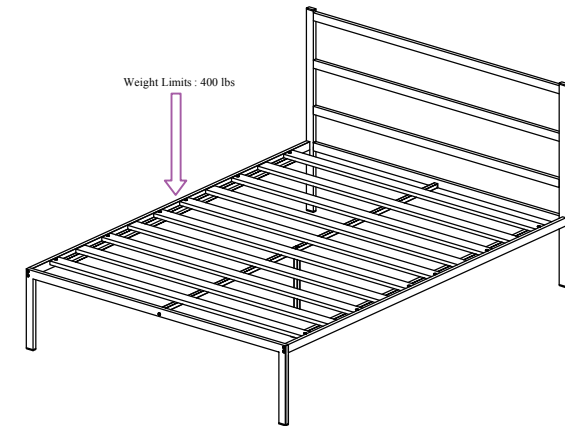

# Before You Start

- ⚠ Please read all instructions carefully.
- ⚠ Retain instructions for future reference.
- ⚠ Separate and count all parts and hardware.
- ⚠ Read through each step carefully and follow the proper order.
- ⚠ We recommend that, where possible, all items are assembled near to the area in which they will be placed in use, to avoid moving the product unnecessarily once assembled.
- ⚠ Always place the product on a flat, steady and stable surface.
- ⚠ Keep all small parts and packaging materials for this product away from babies and children as they potentially pose a serious choking hazard.

## Bushwick Platform Bed ASSEMBLY INSTRUCTIONS

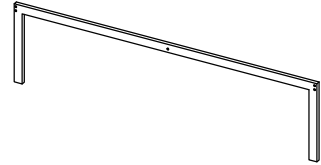
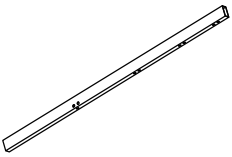
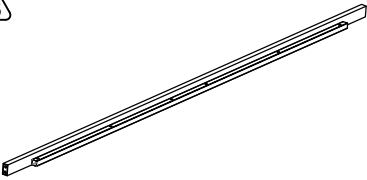

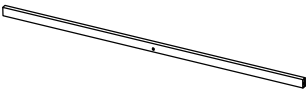



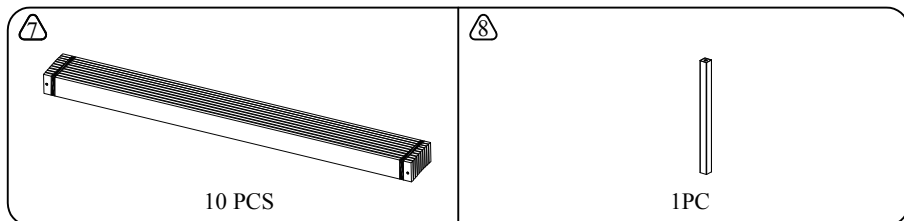

### PART LIST

 1PC	 2PCS
 2PCS	 3PCS
 1PC	 1PC





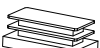





Bushwick Platform Bed  
ASSEMBLY INSTRUCTIONS



HARDWARE LIST

 1/4"*60 14 PCS	 1/4"*40 11 PCS	 1/4"*25 12 PCS
 20x20x10 1 PC	 20x40x10 6 PCS	 4*60 2 PCS

IMPORTANT SAFETY NOTICE: READ CAREFULLY BEFORE BEGINNING ASSEMBLY!

-  Hardware packs and small components should be away from the children, avoid eating and being injured
-  Please, follow with the assembly steps in order
-  Please, do not tighten any screw before each assembling unit is well placed in appropriate position
-  Please, make sure all components are fixed firmly locked without any potential safety hazard  
After assembly and before using
-  Please, use this product correctly, according to its purpose to avoid danger happened
-  Please, do not stand on any component of this product, except the ladder of this product after fixing locked safely
-  Such as the wall fastening devices are essential parts of this product. Please fix firmly locked without any potential safety hazard before using
-  Please check all contents of this product inside of carton (s) carefully, small parts may have been lost during shipment, if any! contact further with the retailer from which you purchased this product to obtain, do not use any substitute part
-  This assembly instructions booklet contains important safety information, please read and keep for further reference
-  This products is designed referring to overall loading of each set final product,  
Please avoid to load on single point of final product making damaged  
product name : Bushwick Platform Bed : 400 LBS (maximum)

Bushwick Platform Bed  
ASSEMBLY INSTRUCTIONS

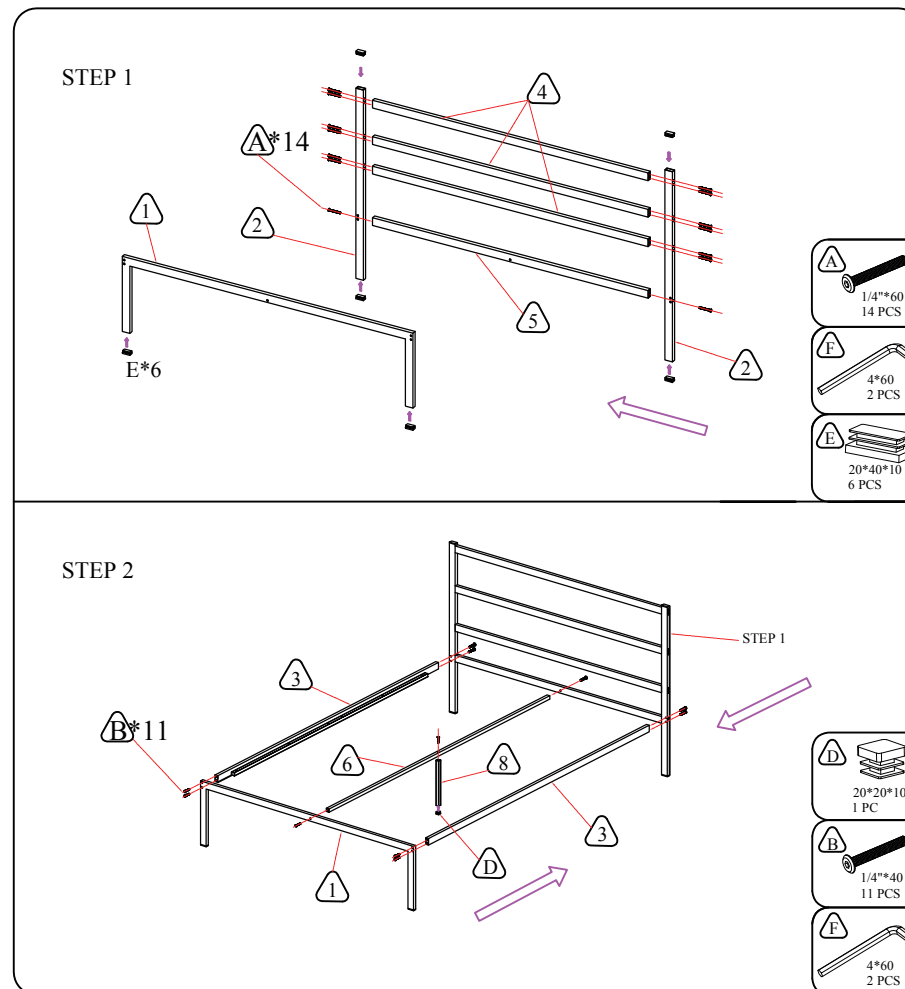

Bushwick Platform Bed  
ASSEMBLY INSTRUCTIONS

STEP 3

