

ASSEMBLY INSTRUCTION FOR ACME FURNITURE





MODEL DN06272

Thank you for purchasing the quality product. Be sure to check all packing material carefully for small part which may have some loose inside the carton during shipment. Separate, identify and count all parts and metal hardware. Compare with all part list to be sure all part are present. If any part(s) are missing or damaged, please contact your local furniture dealer. For efficient and speedy service, please indicate the model number and code letter of part(s) needed.

*** Do not fully tighten screws until fully assembled ***

DESCRIPTION	COMPONENT PART	
	PART NAME	QTY (PCS)
Ⓐ	CHAIR FRAME	1 PC
Ⓑ	CHAIR LEG (L&R)	2 PCS
Ⓒ	FRONT RAIL (LONG)	1 PC
Ⓓ	BACK RAIL (SMALL)	1 PC

HARDWARE REQUIRED

①		JCBC BOLT M6 X 60MM	4 PCS
②		JCBC BOLT M6 X 50MM	4 PCS
③		SPRING WASHER 5/16"	8 PCS
④		ALLEN KEY M4 (BALL SHAPE)	1 PC

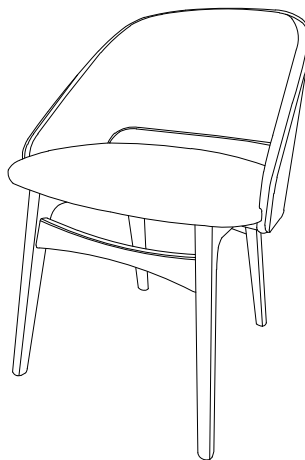

Attention

*** Some number parts listed on the instruction sheet may not be in part bag as they may already be assembled. Carefully check part and packing materials prior to ordering replacements.

How to assemble:

STEP 1

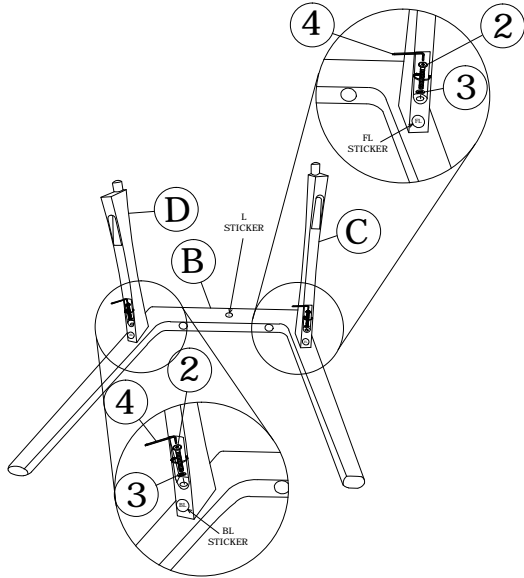

STEP 2

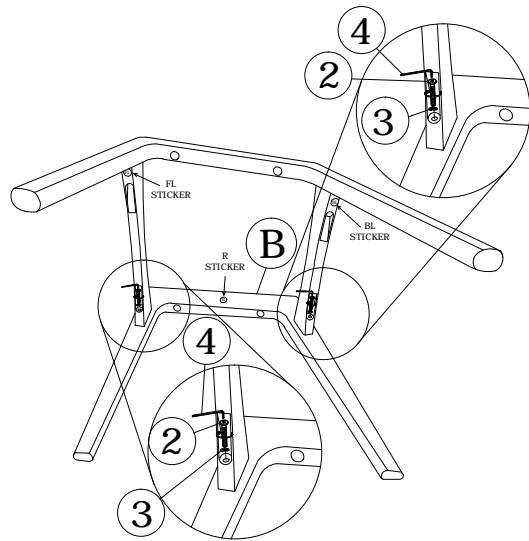

STEP 3

