

ROD SETS INSTALLATION INSTRUCTIONS

NOTE: Finial shown is for illustration purposes only. It may not represent the style of finial purchased.

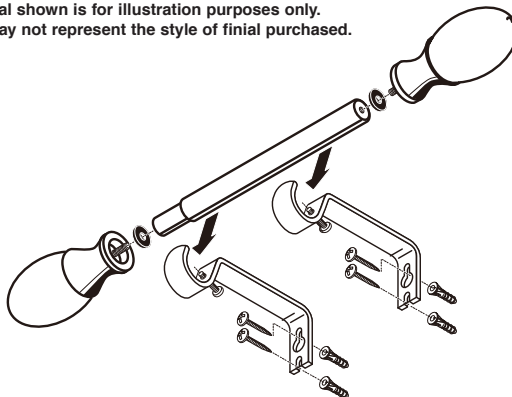

STEP 1:

Place brackets against wall at desired locations. Mark screw holes with pencil. Be sure marks are level across opening.

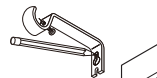
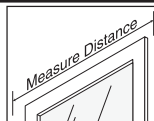

STEP 2:

If screws are going directly into wood trim or wall studs, drill a 1/8" pilot hole at pencil marks. If screwing into drywall, follow instructions on enclosed sheet.

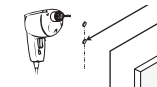

STEP 3:

Assemble rod and slide drapery treatment onto rod.

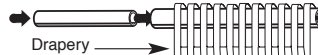

STEP 4:

Screw finials onto rod. Rotate finial on rod for proper alignment if required.

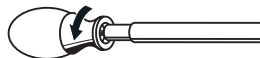

STEP 5:

Extend rod to desired width. Lift rod with drapery and drop into brackets. Adjust draperies to desired position.

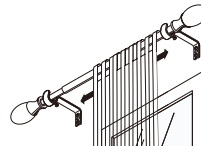

STEP 6:

Lock rods into position by tightening leveling screw by hand until finger tight. This will prevent the rod from moving.

