

parts list

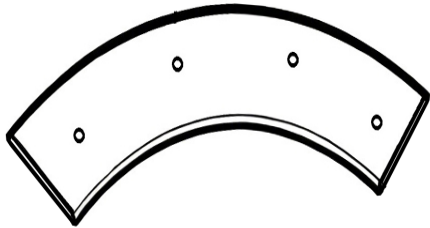

base pads 8pcs

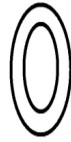

washer 16pcs

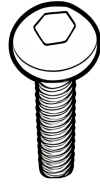

M6*30mm 12pcs

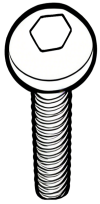

M6*35mm 4pcs

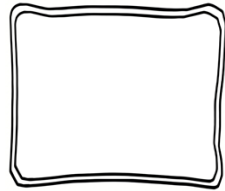

pillow 2pcs



spanner 1pc

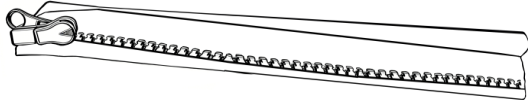

trim strip 4pcs

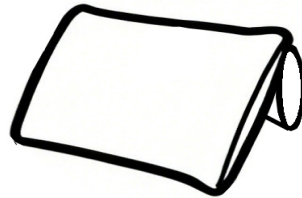

back support 1pc

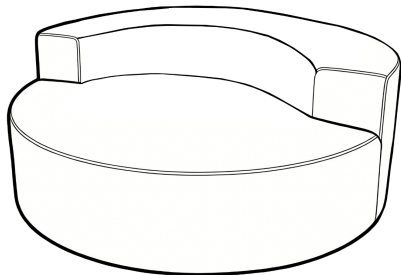

sofa body 1pc

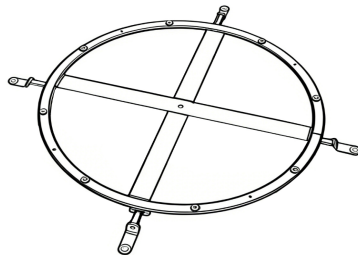

mechanism 1pc

1. Assembling the round base, using the screws: M6*30mm.

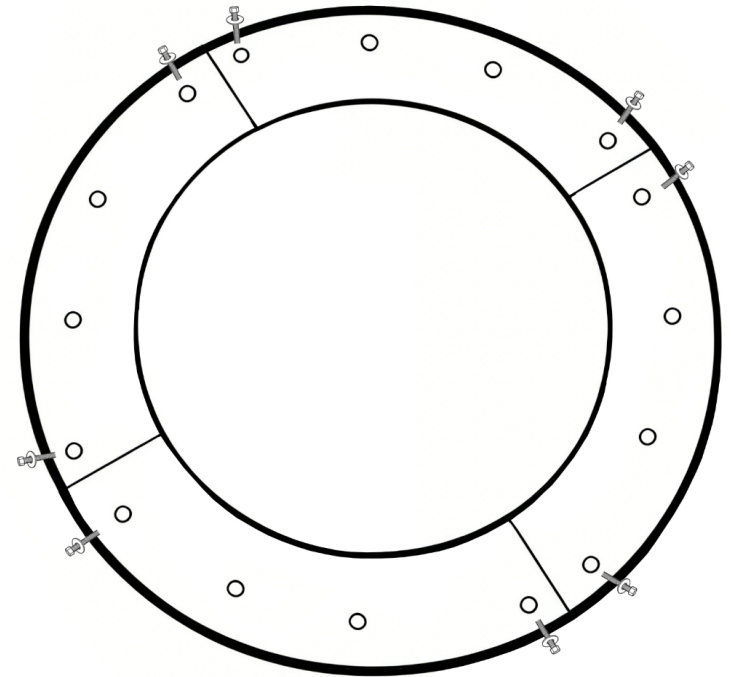
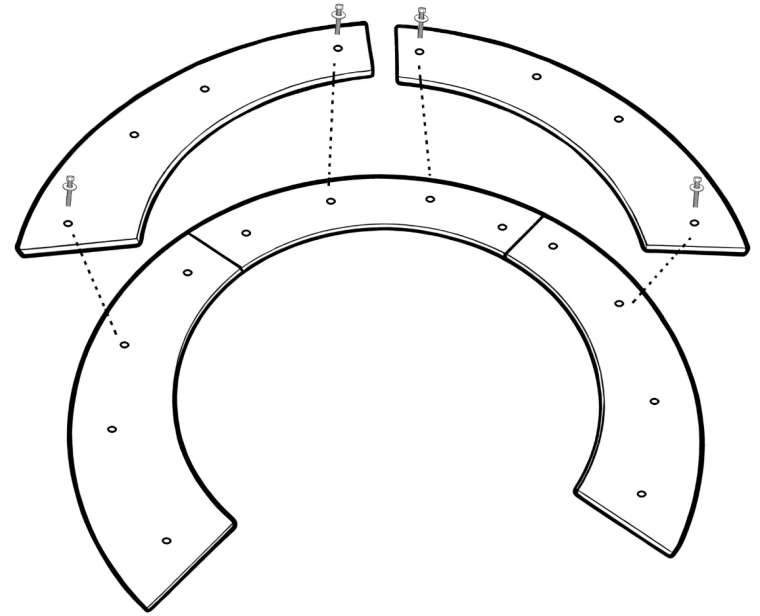

2. Turn over the base, assembling the round base and mechanism.

unlocking this 4pcs screws before assembling the mechanism, after assembling the mechanism, relocking again.

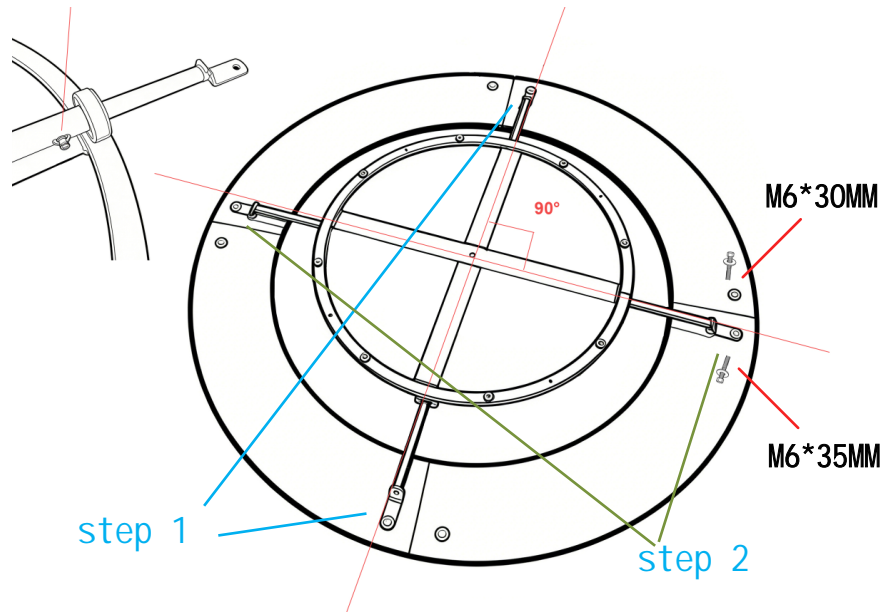

4. Assembling the base and sofa by velcro.

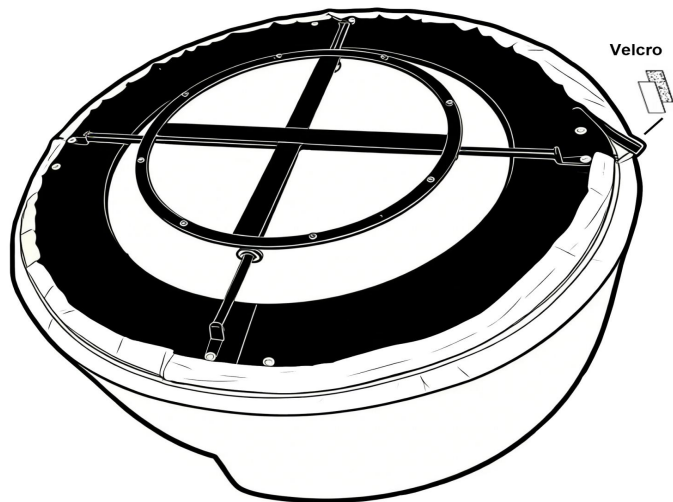

3. zippered the 4pcs trim strips with sofa body.

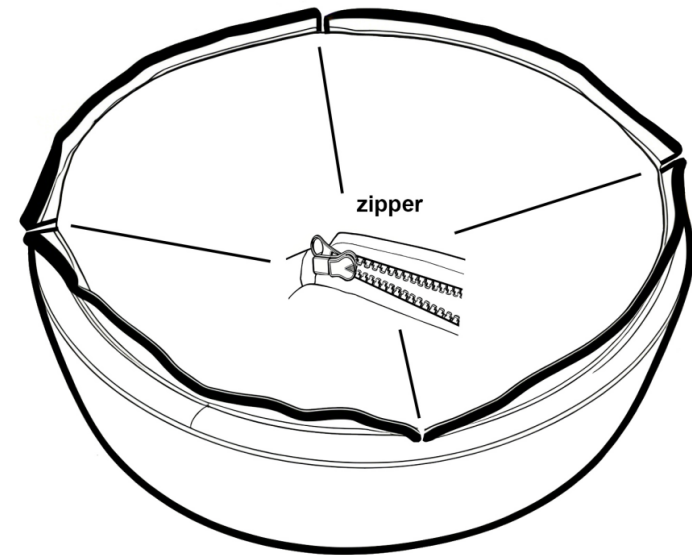

5. put the cushions on the sofa body.

