

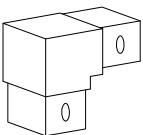

10'

1

<p><b>A</b></p>  <p><b>x 8</b></p>	<p><b>B</b></p>  <p><b>x 4</b></p>	<p><b>C</b></p>  <p>M6 x 34</p> <p><b>x 4</b></p>
---	---	--

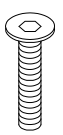
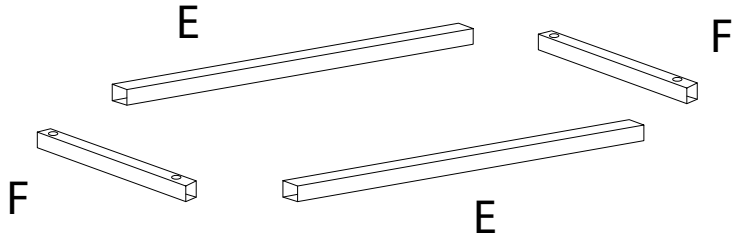
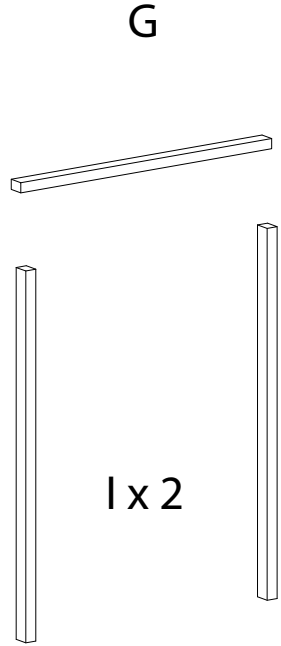
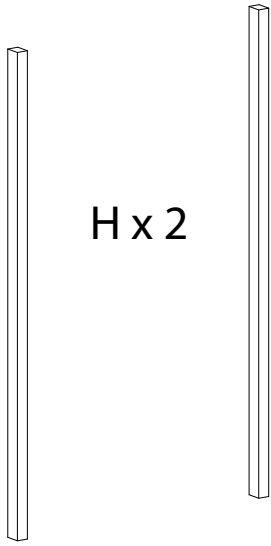
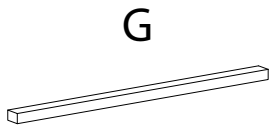

D



x 1

E

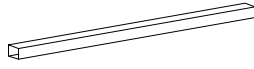

x 2

F

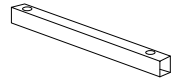

x 2

G



x 2

H



x 2

I



x 2

1

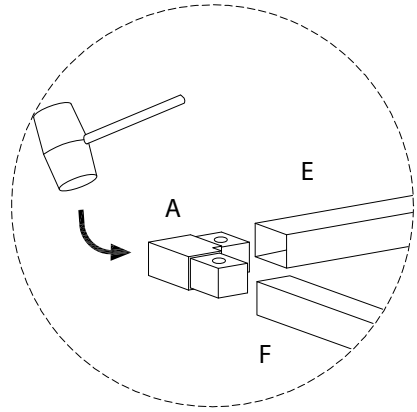
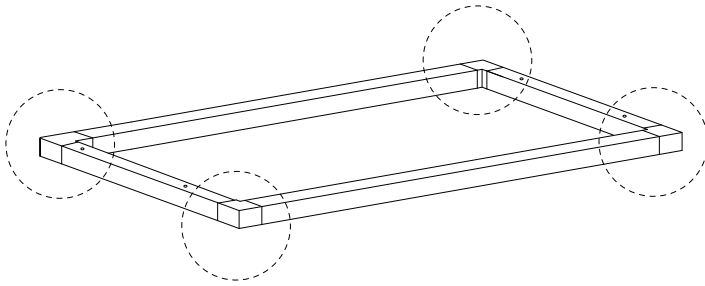
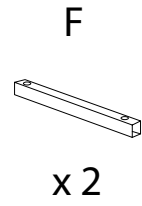
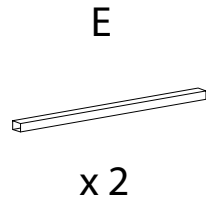
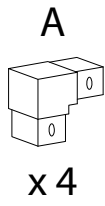

2

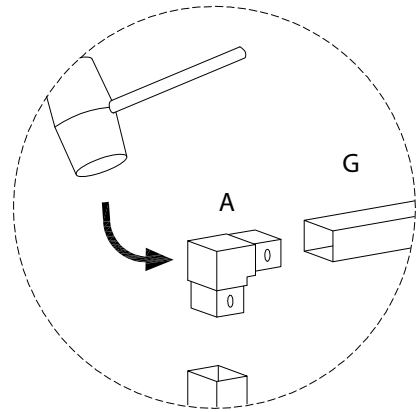
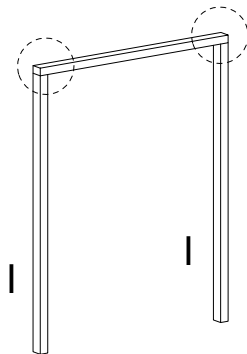
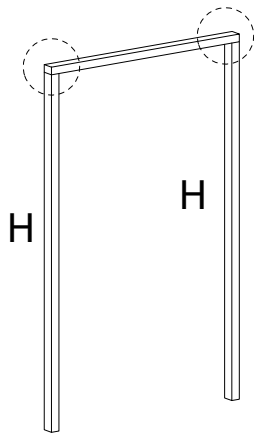
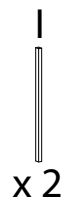
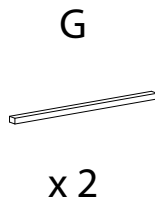
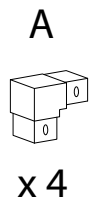

3

C



x 4

D

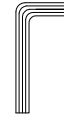

x 1

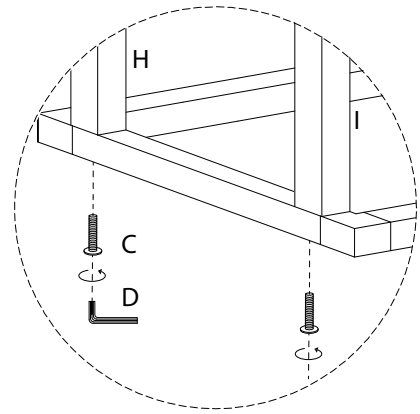
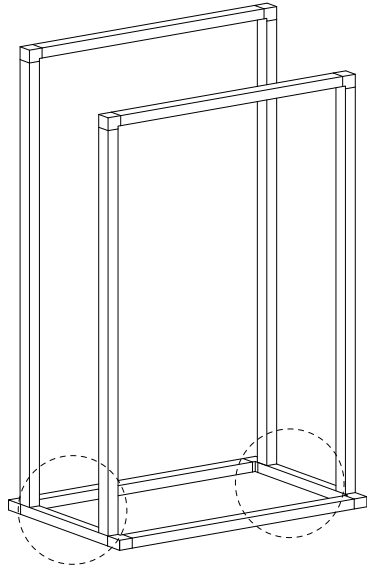

4

B



x 4

