

# Assembly Instructions

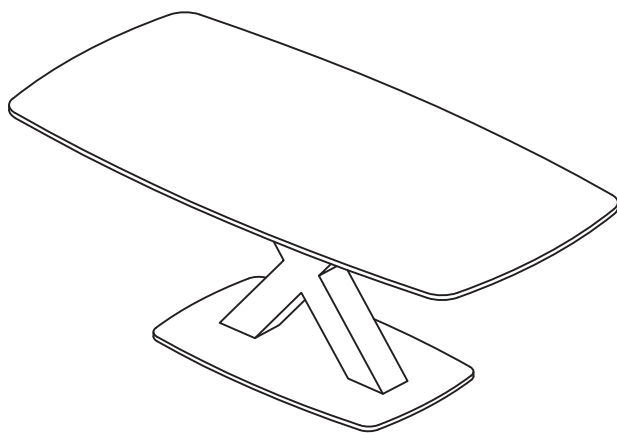

## Vermont Coffee Table



20 Minutes  
2 Persons Assembly

Assembly Tools Are Provided

# IMPORTANT! READ CAREFULLY AND RETAIN FOR FUTURE REFERENCE

Due to small parts keep children clear during assembly.

Carefully layout all the parts on a clean, flat surface and compare with the parts checklist. Please retain all packaging until you are sure no parts are missing, then once you are satisfied with the product please dispose of all packaging responsibly.

Ensure all fittings are fully tightened before use and checked regularly and re-tighten as necessary.

During assembly take care not to overtighten the bolts.

When positioning your furniture ensure the ground is firm, level and dry.

Do not position your furniture in direct sunlight or close to a source of heat.

Take care when handling or moving furniture, always lift with assistance to avoid damaging your product.

Do not stand or climb on this Table.

To maintain the appearance of your unit, regular dusting with a soft cloth will be adequate.









For grime stains, wipe with a damp cloth and mild detergent.

Do not use any solvent based or abrasive cleaning products as this could damage your furniture.

Care and maintenance of your furniture is important, so please follow the advice given in the guide provided.

If you require any additional information, replacement parts or have any queries please contact your retailer.

# Components List

<p>A-1pc</p>  <p>Top</p>	<p>B-1pc</p>  <p>Leg</p>	<p>C-1pc</p>  <p>Base</p>	<p>D-4pcs</p>  <p>Bolt</p>
<p>E-4pcs</p>  <p>Bolt</p>	<p>F-4pcs</p>  <p>Flat Washer</p>	<p>G-4pcs</p>  <p>Spring Washer</p>	<p>H-1pc</p>  <p>Allen Key</p>

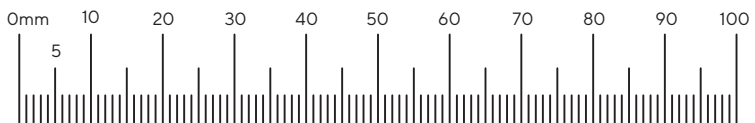

# Step-1

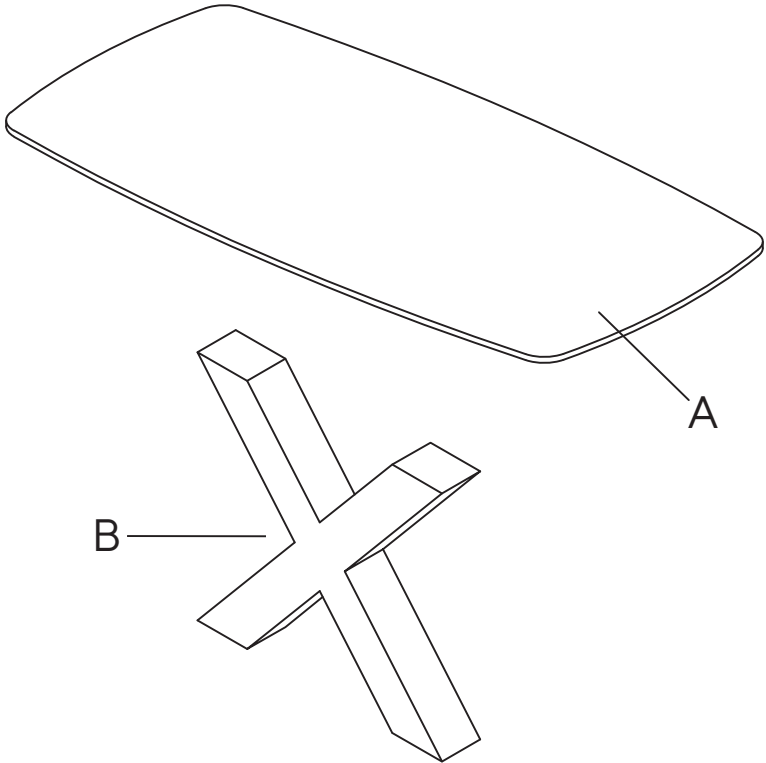

# Step-2

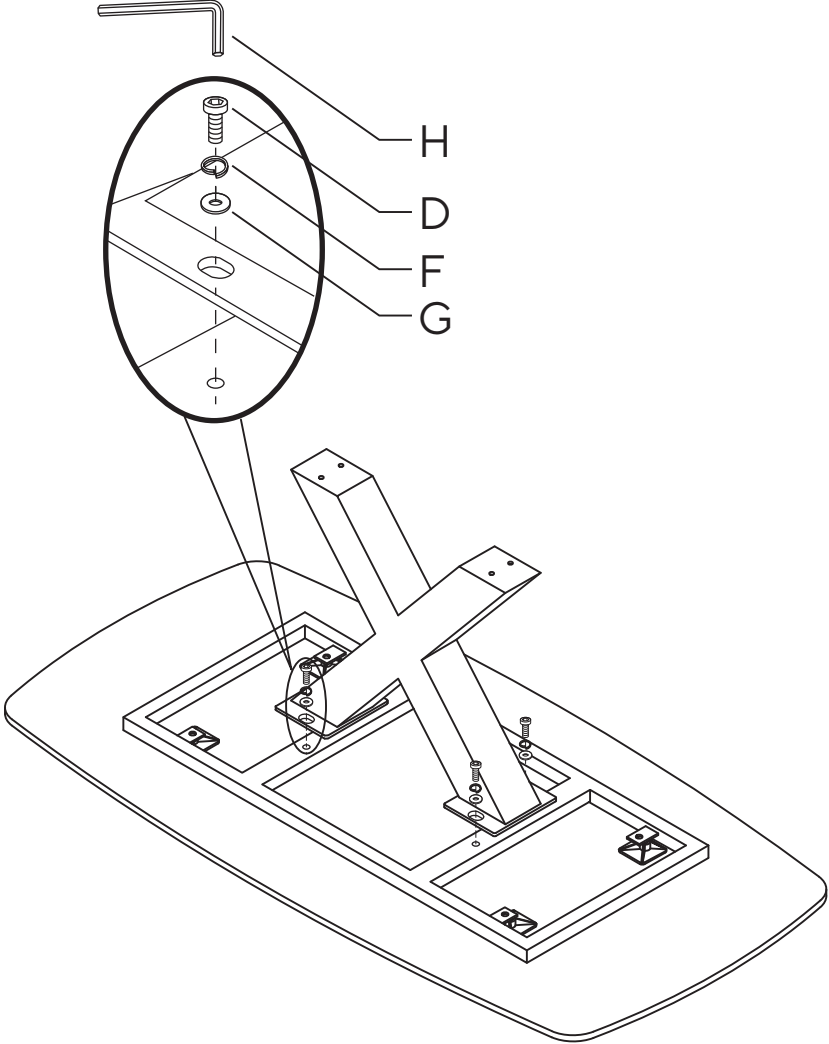

# Step-3

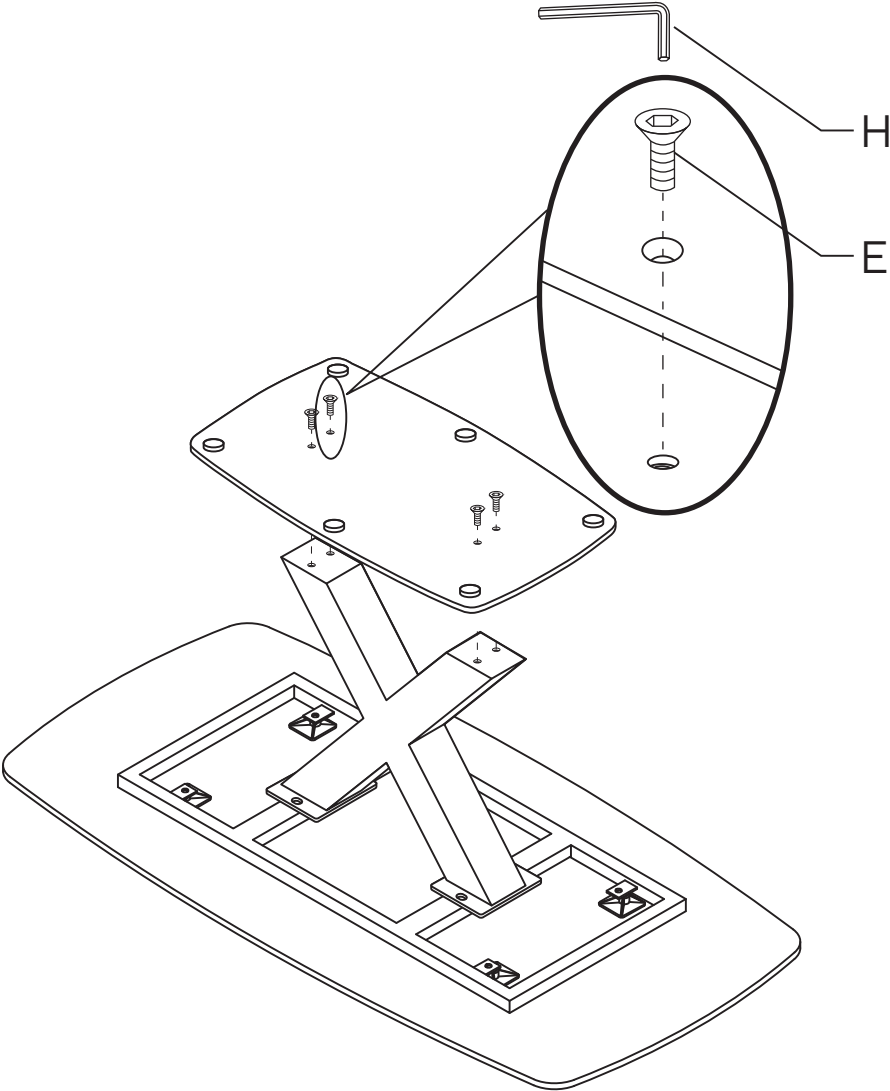

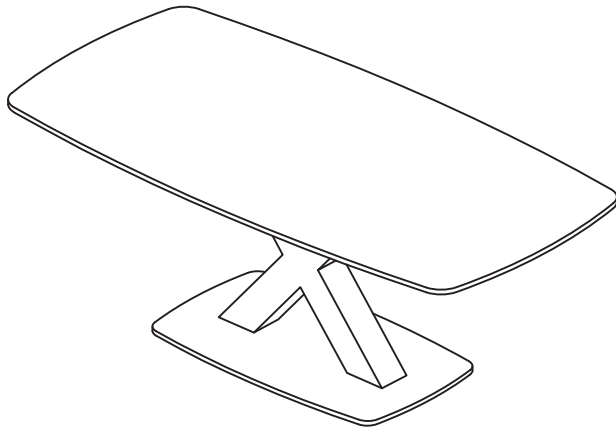

Assembly Complete

If you require any additional information,  
replacement parts or have any queries  
please contact your retailer.