

ASSEMBLY INSTRUCTIONS

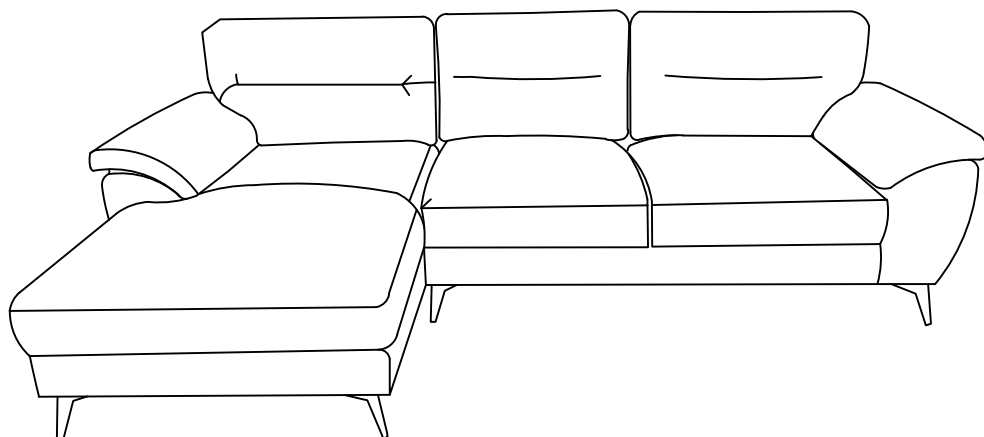

TOOLS REQUIRED



Allen Wrench

(Included)



Phillips
Screwdriver

(Not Included)



2 - People
Recommended

ASSEMBLY RATING



EASY ————— DIFFICULT

The Assembly Rating is a 5-point system that shows the degree of effort needed in assembling a specific product (with 1 being easy and 5 being difficult). For some products, two persons are recommended.



CHECK BEFORE STARTING

Are you missing anything?

Double-check all parts, hardware and accessories listed are all accounted for.

Check out our Quick Tips!

We recommend reviewing the pre-assembly handouts. Even experts need a refresher now and then!

Should we send any replacements?

Are there any irregularities or flaws in the parts? We can send replacements!

Prep Time!

Please review the assembly instructions and all diagrams prior to assembling.

PRE ASSEMBLY INTRODUCTION

We understand building ready-to-assemble furniture can be a challenging experience for some. To help avoid confusion, we have provided some helpful tips that may speed up the process.



Teamwork

ALWAYS have at least two people to help with transporting and assembling the product to avoid potential injury and/or damage.



Suitable Location

Assembling near the area of the intended location is highly recommended.



Sufficient Space

Make sure you have enough space to move around during the assembly.

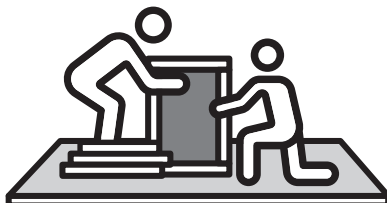

Avoid Scratches

Use cardboard, blankets or a carpeted area while assembling furniture to prevent to prevent scratches and damages.



Flat Surface

Make sure the furniture rests on a flat and level surface with each leg evenly touching the floor.

ASSEMBLY AND CARE ADVICE



FAILURE TO FOLLOW THE GUIDELINES BELOW MAY RESULT IN INJURY AND/OR PROPERTY DAMAGE.



Position each part correctly and insert screws or bolts into their respective holes.



Turn clockwise to tighten and only tighten when step is completed or when instructed to do so.



Use the appropriate hand tools or power tools for assembly. Select steps, such as tightening screws and/or bolts, may require hand tools to avoid causing damage during assembly.



Save the instructions and store any supplied tools for later maintenance.



After two weeks, check and tighten any loose hardware and repeat again every six months thereafter.

IT IS THE USER'S RESPONSIBILITY TO MAINTAIN THE FURNITURE. THE HARDWARE MAY LOOSEN OVER TIME AND MAY CAUSE THE FURNITURE TO BE WOBBLY AND UNABLE TO SUPPORT ITS INTENDED WEIGHT CAPACITY. THIS MAY LEAD TO COLLAPSE AND MAY CAUSE SERIOUS INJURY.

SOFA

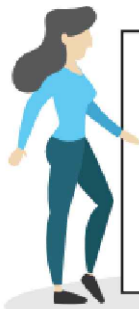

- Please keep instructions for future reference.
- Check the quantity and irregularity of parts and hardware before you start.

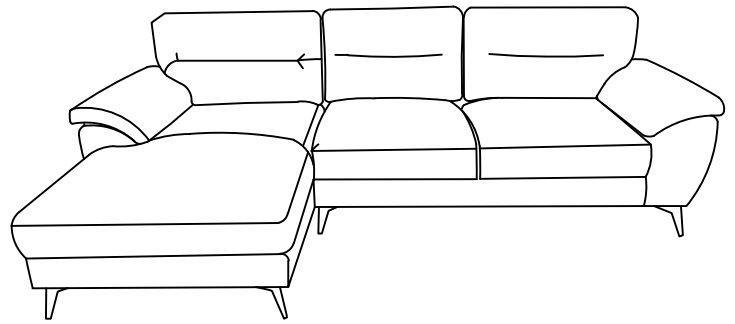

PARTS

#1 1pc

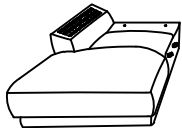

Left Chaise

#2 1pc

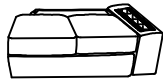

Right Loveseat

#3 1pc

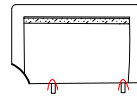

Left Backrest

#4 1pc

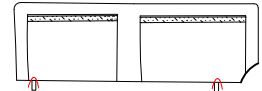

Right Backrest

#5 1pc



Left Back Cushion

#6 1pc



Middle Back Cushion

#7 1pc



Right Back Cushion

#8 2pcs

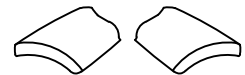

Arm (L&R)

HARDWARE

#A 36pcs



Screw M10 x 25mm

#B 9pcs



Legs

#C 18pcs



Bolt Ø5/16"x1-1/4"

#D 18pcs



Lock Washer
Ø5/16"

#E 18pcs



Flat Washer
Ø5/16" x 19mm









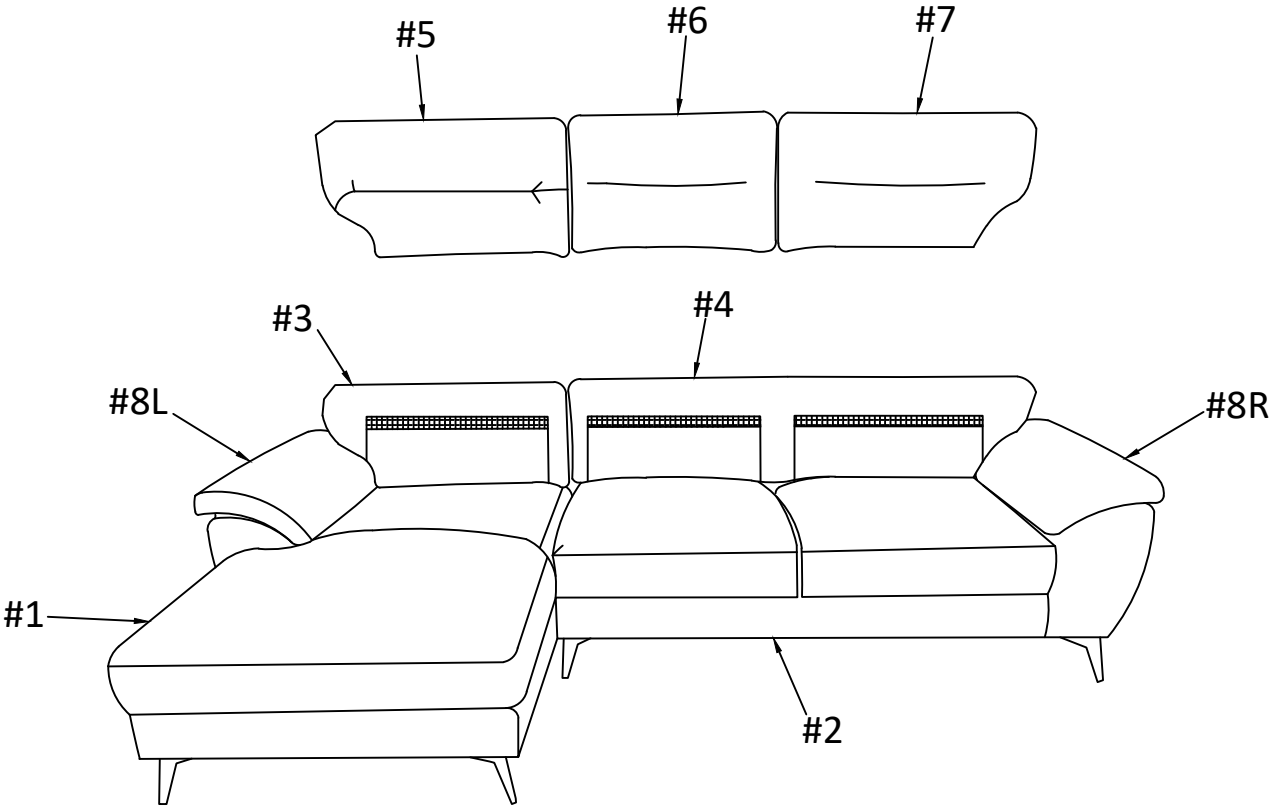

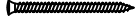

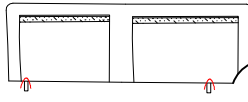





#F 2pcs

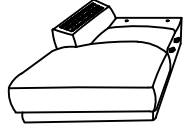

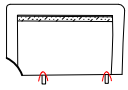
Allen wrench 5mm

Exploded View



Carton	Disignation	Part		Hardware
	Right Loveseat	#2		 #A x 16pcs  #B x 4pcs
	Right Backrest	#4		 #C x 8pcs  #D x 8pcs
	Middle Back Cushion	#6		 #E x 8pcs
	Right Back Cushion	#7		 #F x 1pc
	Arm (R)	#8R		
	Left Chaise	#1		 #A x 20pcs  #B x 5pcs
	Left Backrest	#3		 #C x 10pcs  #D x 10pcs
	Left Back Cushion	#5		 #E x 10pcs
	Arm (L)	#8L		 #F x 1pc

ASSEMBLY INSTRUCTIONS

1

Align the Legs (#B) to the pre-drilled holes on the Right Love seat (#2) and attach using Bolts (#C) with Lock Washer (#D) and Flat Washer (#E). Then use Screws(#A) to secure.

Part #2 x1pc

Hardware #A x16pcs

Hardware #B x4pcs

Hardware #C x8pcs

Hardware #D x8pcs

Hardware #E x8pcs

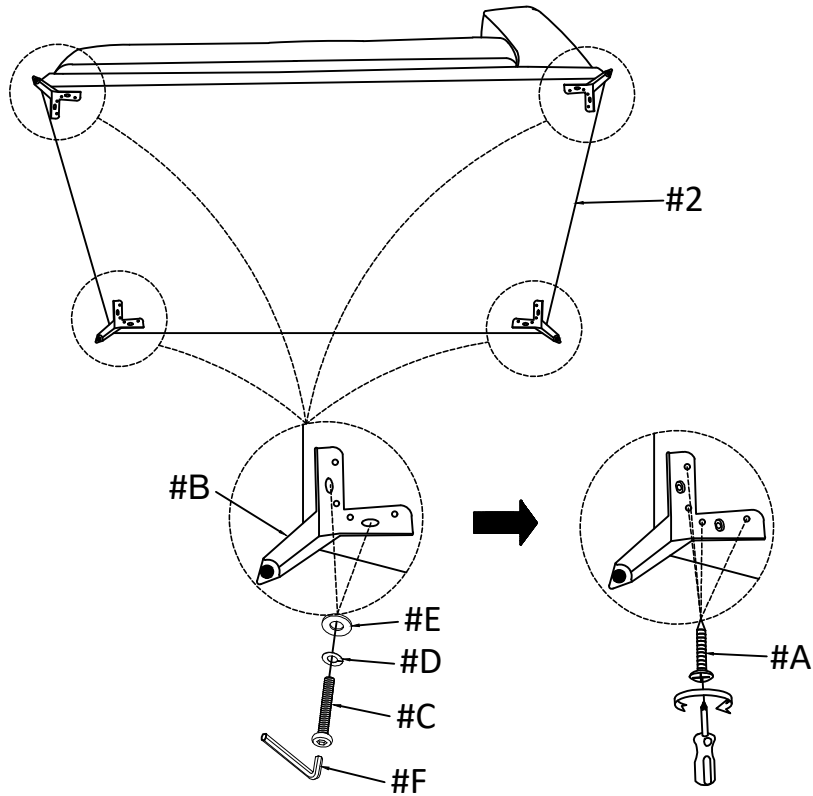

2

Align the Legs (#B) to the pre-drilled holes on the Left Chaise (#1) and attach using Bolts (#C) with Lock Washer (#D) and Flat Washer (#E). Then use Screws(#A) to secure.

Part #1 x1pc

Hardware #A x20pcs

Hardware #B x5pcs

Hardware #C x10pcs

Hardware #D x10pcs

Hardware #E x10pcs

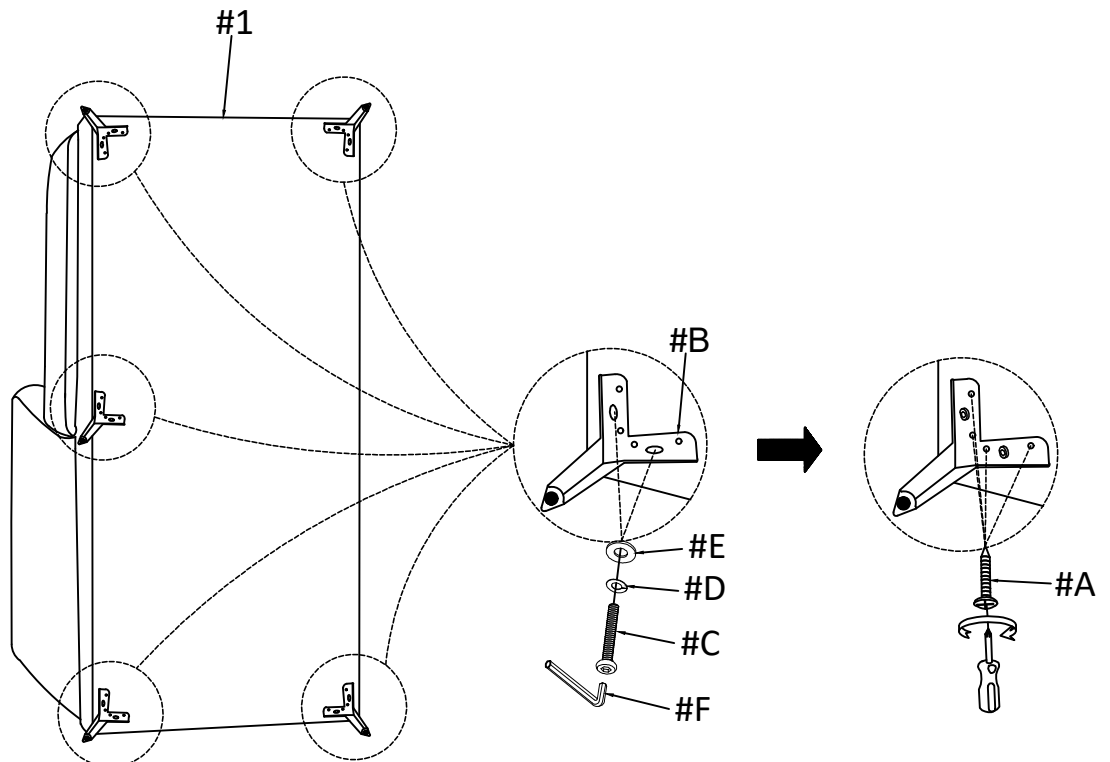

ASSEMBLY INSTRUCTIONS

3

Part ① #1 x1pc
Part ② #8 x1pc

Attach the Left Arm (#8)
to the chaise (#1)

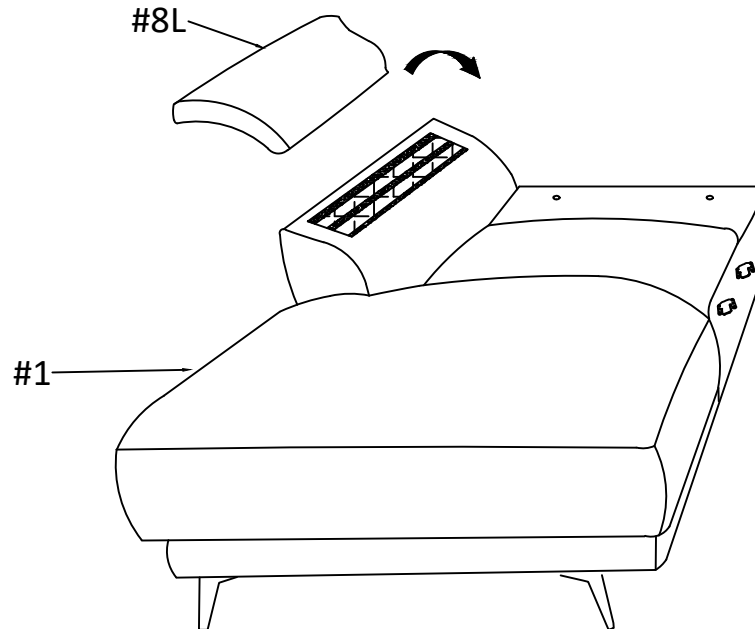

4

Part ③ #3 x1pc

Attach the Left Backrest (#3) to the left Chaise (#1).

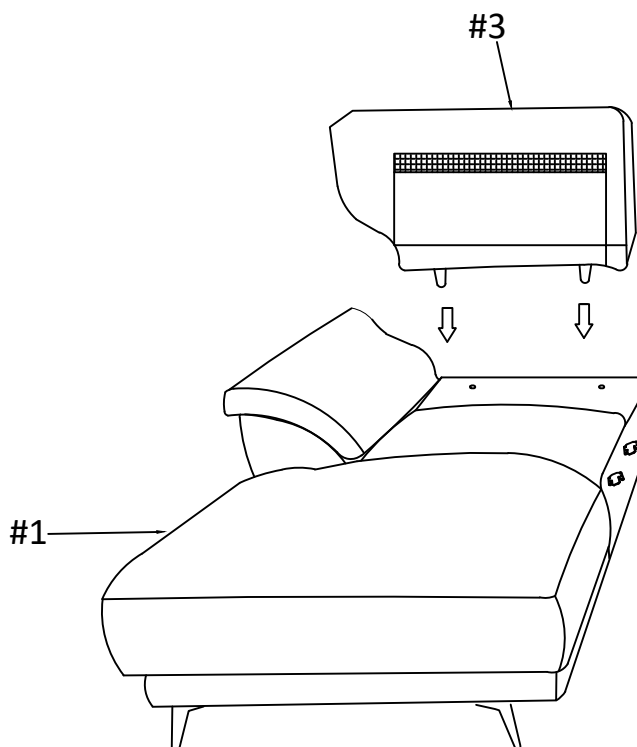

ASSEMBLY INSTRUCTIONS

5

Part #2 x1pc
Part #8 x1pc

Attach the Right Arm
(#8) to the love seat (#2)

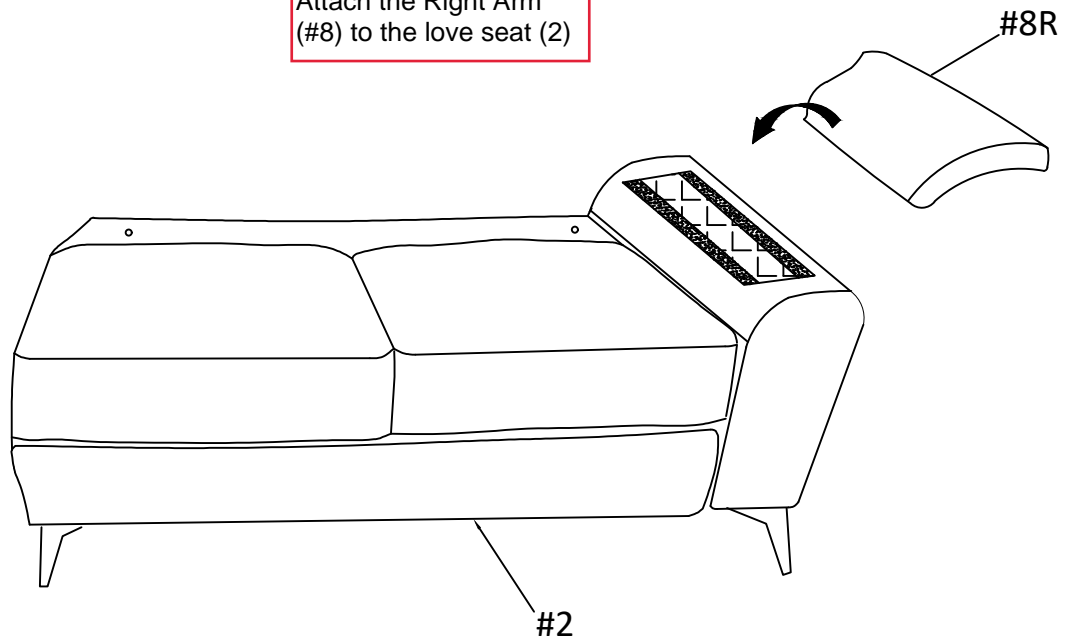

6

Part #4 x1pc

Attach the Right Backrest (#4) to the Right Loveseat (#2).

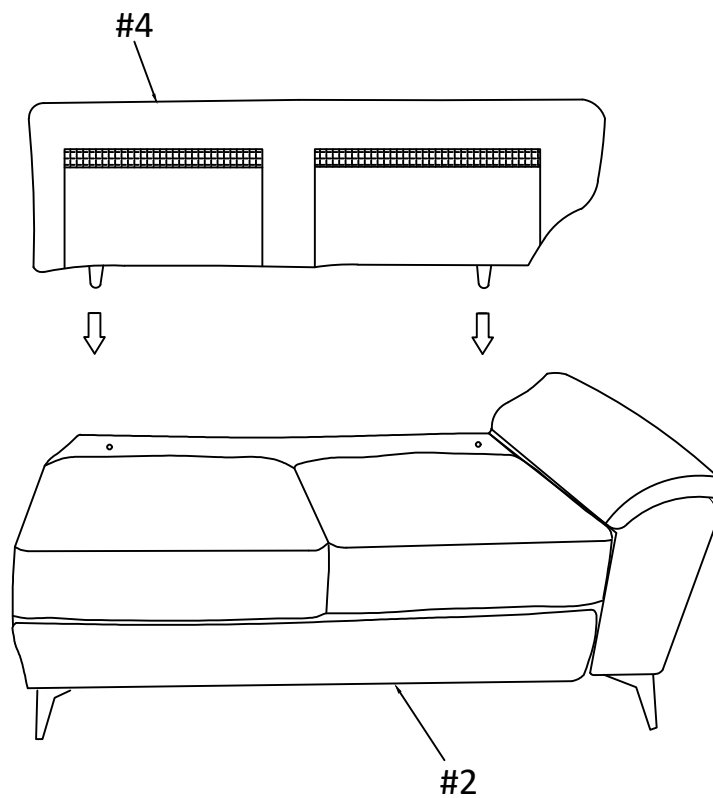

ASSEMBLY INSTRUCTIONS

7

Lift and hook metal brackets of the left chaise (#1) to the metal brackets of the Right Backrest (#2).

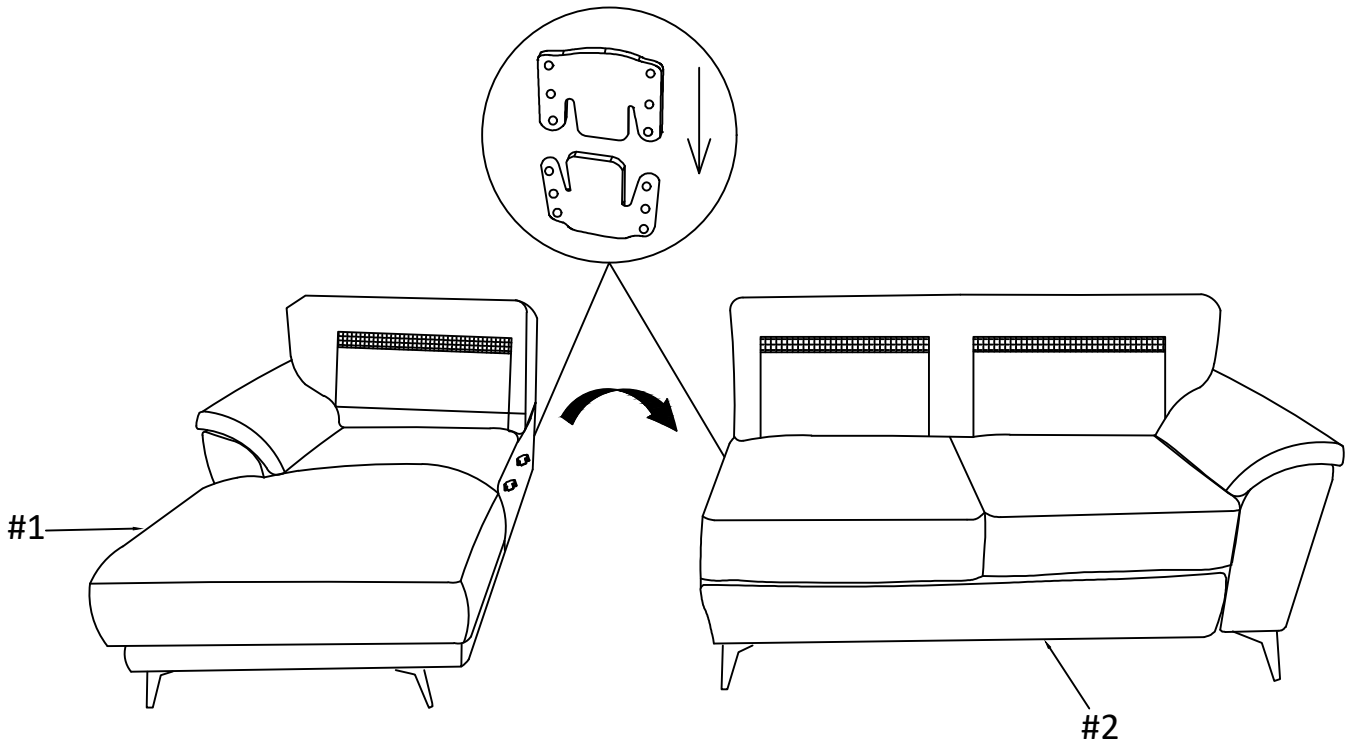

8

Place the Back Cushions.

- Part #5 x1pc
- Part #6 x1pc
- Part #7 x1pc

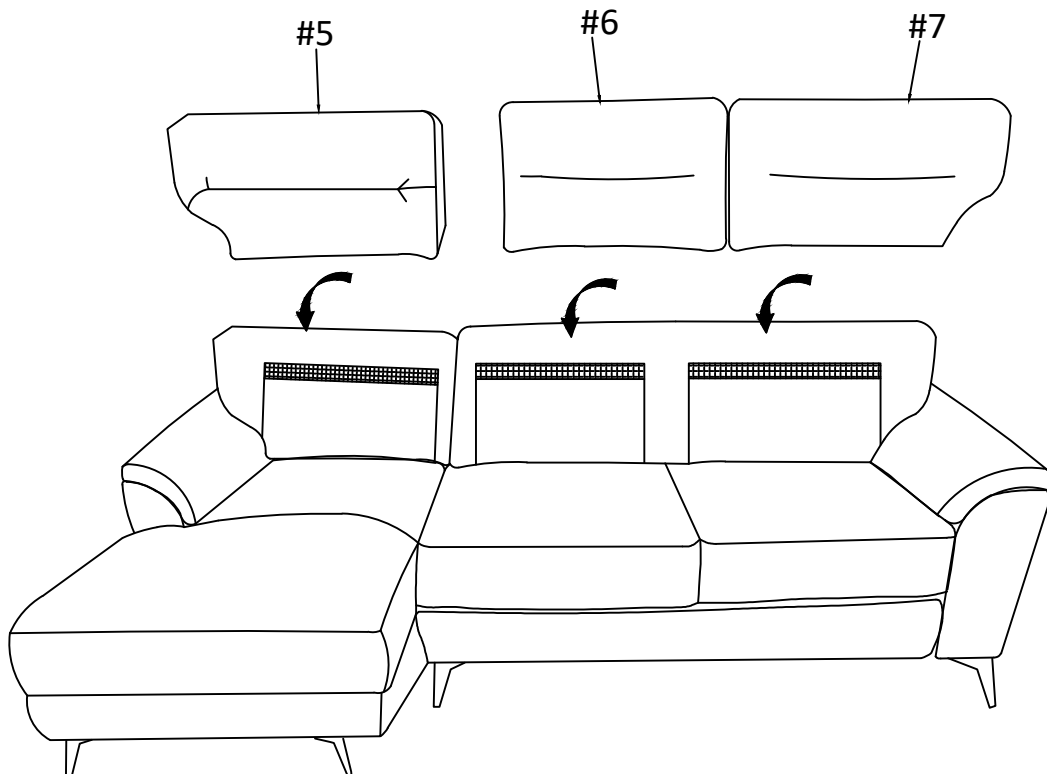

ASSEMBLY INSTRUCTIONS

9

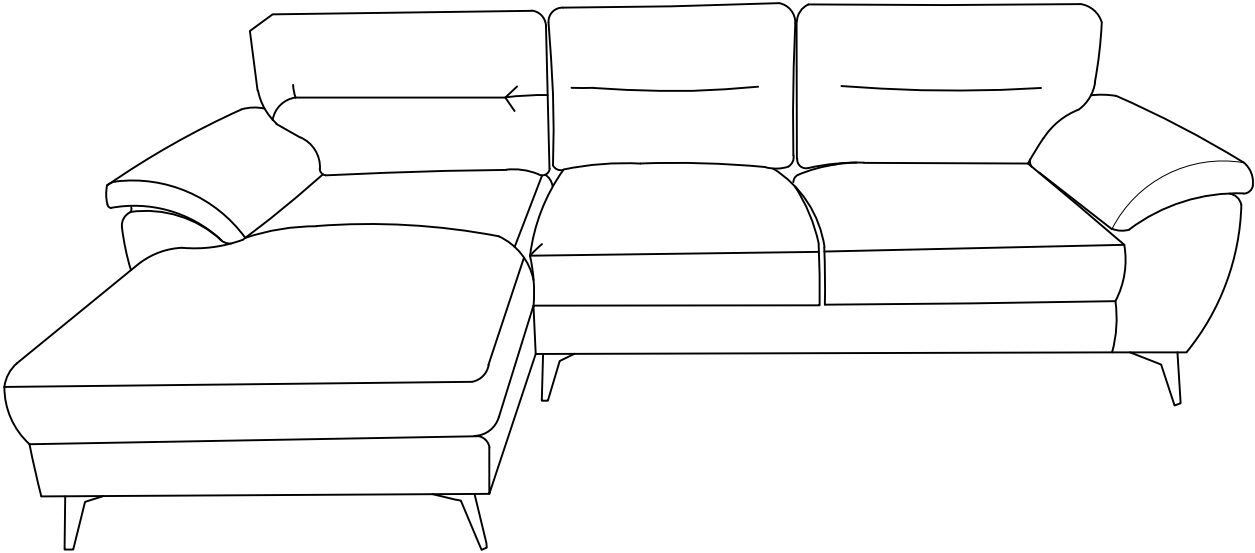

ASSEMBLY COMPLETED



Please ensure the furniture rests on an even and flat surface. If the product wobbles or feels loose, double-check all bolts and/or screws are properly tightened and secured.



Keep this handy!

Please retain this instruction manual and any order-related information for future reference.



Lift, don't drag!

To avoid damage to product please always LIFT the product when transporting or adjusting the placement.