

KINCAID

—SOLID WOOD SINCE 1946—







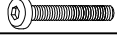

www.kincaidfurniture.com

phone :828-728-3261.

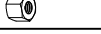
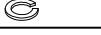
ASSEMBLY INSTRUCTION

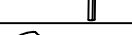
161-637 Renner Arm Chair

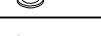
HARDWARE LIST

A		Bolt	Ø5/16"*3-1/8"	4 PCS
B		Bolt	Ø5/16"*1-3/4"	1 PCS
C		Nut	Ø5/16"	4 PCS
D		Lock Washer	Ø5/16"	9 PCS
E		Flat Washer	Ø5/16"*19D	9 PCS
F		Allen Key	100*50*4mm	1 PC
G		Spanner Wrench	12MM	1 PC
H		Bolt	Ø1/4"*1-1/8"	2 PCS
I		Lock Washer	Ø1/4"	2 PCS
K		Screw	Ø8*1-1/4"	4 PCS
L		Wood Plug		2 PCS

PART LIST

1	Chair Back	1 PC
2	Seat Frame	1 PC
3	Left Front Leg	1 PC
4	Right Front Leg	1 PC
5	Stretcher Frame	1 PC

IMPORTANT NOTES

- . Place all wooden parts on clean and smooth surface such as rug or carpet to prevent the parts from being scratched.
- . Check to be sure that you have all parts and hardware.
- . Remove all wrapping materials, including staples and packing straps before you start to assemble.
- . Do not tighten all screws and bolts until completely assembled.
- . Keep all hardware out of the reach of children

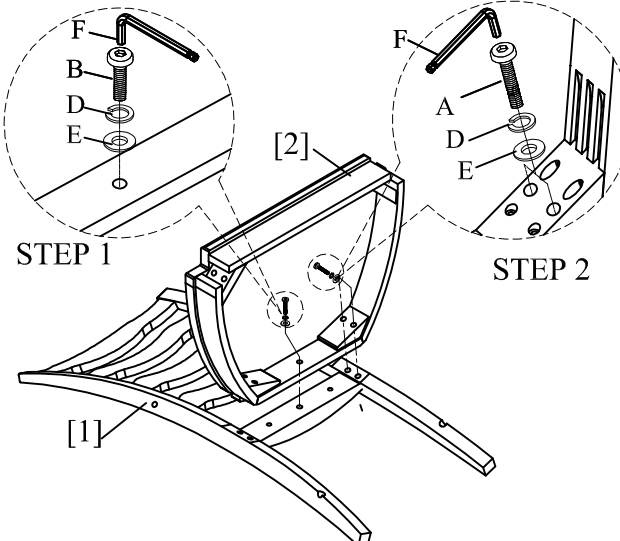

STEP 1 Place chair back (1) on a clean & padded surface then attach seat frame (2) to the chair back using bolt (B), lock washer (D), flat washer (E), and tighten with allen key (F). Important: Do not over-tighten.

STEP 2 Attach back assembly to the seat frame (2) using bolt (A), lock washer (D), flat washer (E), and tighten with allen key (F). Important: Do not over-tighten.

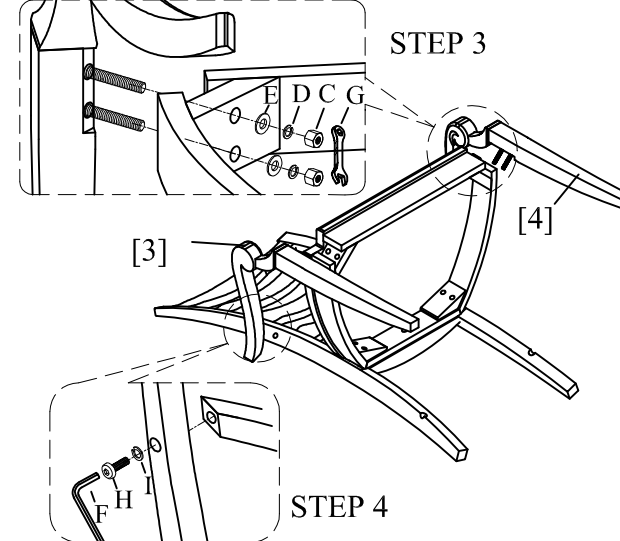

STEP 3 Attach the left front leg (3) and right front leg (4) to the seat frame (2) using nut (C), lock washer (D), flat washer (E), and tighten with spanner wrench (G). Important: Do not over-tighten.

STEP 4 Attach the left front leg (3) and right front leg (4) to chair back side, secure with lock washer (I) and bolt (H). Tighten the bolt (H) with allen key (F). Important: Do not over-tighten.

MADE IN VIETNAM

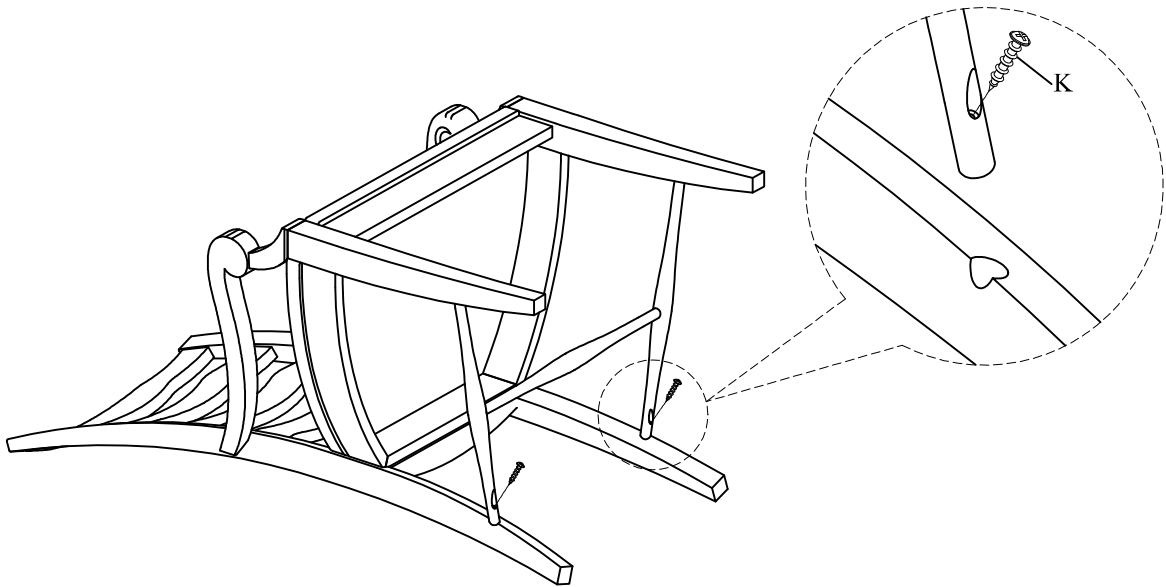

STEP 5. Attach the stretcher frame (5) to the back and front legs with screw (K) and tighten with screwdriver . Important: Do not over-tighten

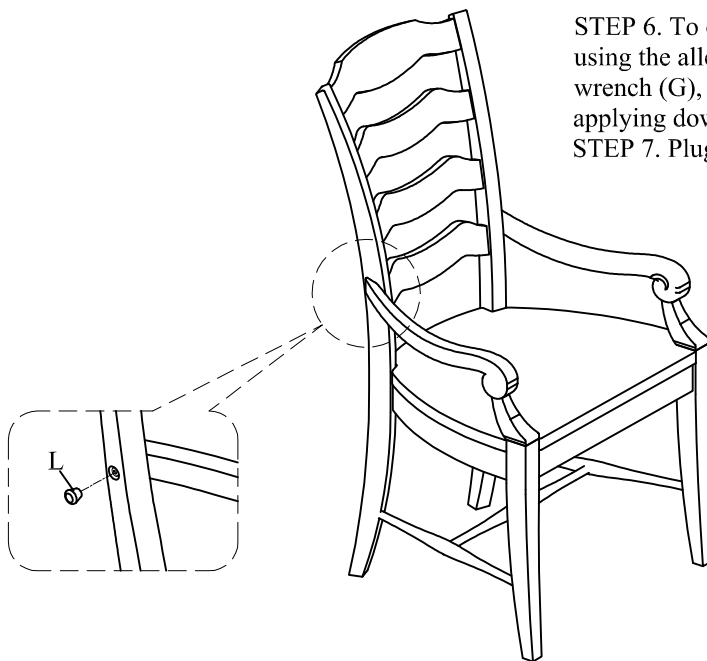

STEP 6. To ensure chair is stable, tighten bolts (A,B,H), using the allen key (F), tighten nuts (C) using spanner wrench (G), tighten screw (K) using the screwdriver while applying downward pressure to the seat.

STEP 7. Plug the wooden Plug (L) to the back leg