

WARNING

*This portable lamp has a polarized plug (one blade is wider than the other) as a safety feature to reduce the risk of electric shock. this plug will fit in a polarized outlet only one way. if the plug does not fit fully in the outlet, reverse the plug, if it still does not fit, contact a qualified electrician.

*Never use with an extension cord unless the plug can be fully inserted. do not attempt to defeat this safety feature.

CARE AND MAINTENANCE

*Unplug lamps before using any cleaning solutions. Dust shades with a feather duster or with an appropriate vacuum-brush attachment. Wipe with a soft, dry cloth and clean lamp bases with the methods appropriate to the material. Avoid the use of chemicals and household cleaners as they may damage the finish.

NOTICE& IMPORTANT SAFETY INSTRUCTIONS

* Please make sure that you have all parts indicated before you begin assembly of this item







* This item should be assembled on a soft surface to prevent scratching the finish during assembly

* To reduce the risk of fire, electrical shock or injury to persons or property, please follow the guideline below for safe use and installation

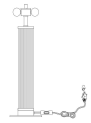
* The external flexible cable or cord of this luminaire cannot be replaced

* If the cord is damaged, the luminaire shall be destroyed

Part List and Hardware List

PIECE	DESCRIPTION	PICTURE	QUANTITY	PIECE	DESCRIPTION	PICTURE	QUANTITY
A	Lamp base		1X	D	Shade		1X
B	Tube		1X	E	Finial		1X
C	Gasket		1X	F	Bulb		2X

 **SAFAVIEH**
LIGHTING

Model# TBL4682

Product Dimensions:15"L x 15"W x 23.5"H

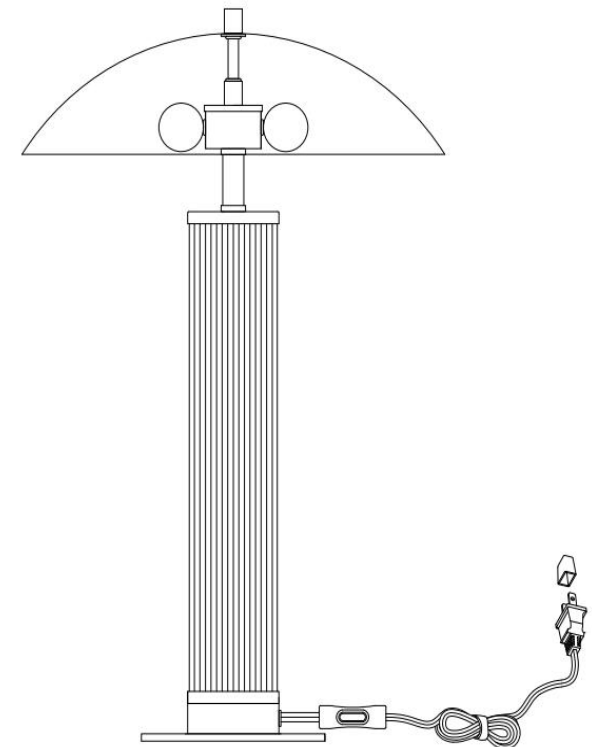

PREPARATION

- * Before beginning assembly of product, make sure all parts are present. Compare parts with package contents list and hardware contents list.
- * If any part is missing or damaged, do not attempt to assemble the product.
- * Estimated Assembly Time: 6 minutes.
- * If you are having difficulty, our friendly Customer Care team is always here to help. Please email customersupport@safavieh.com

PLEASE USE ON/OFF TYPE "A" BULB MAX 40-WATT OR LED BULB MAX 9-WATT.THERE IS LED 4-WATT BULB IN THE BOX.

1

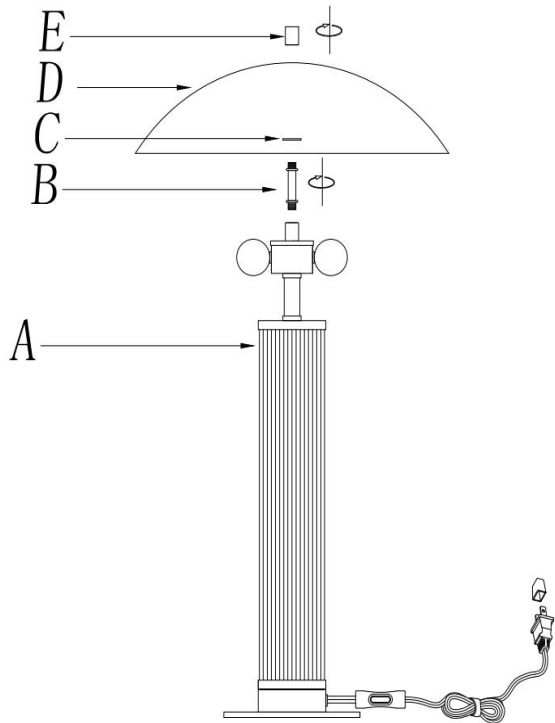

2

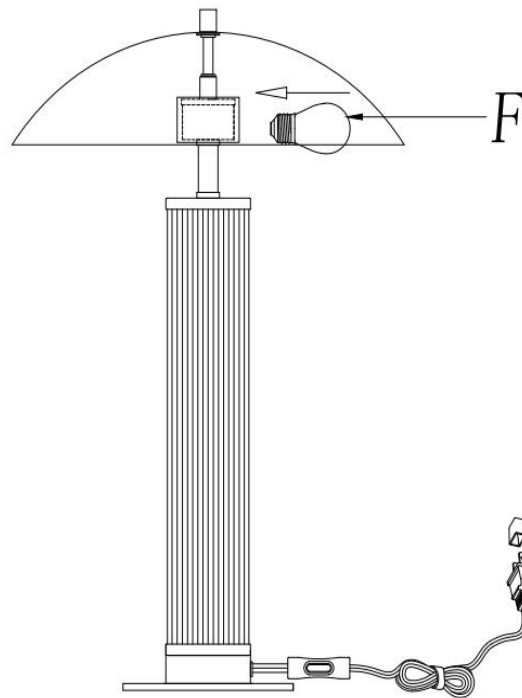

3

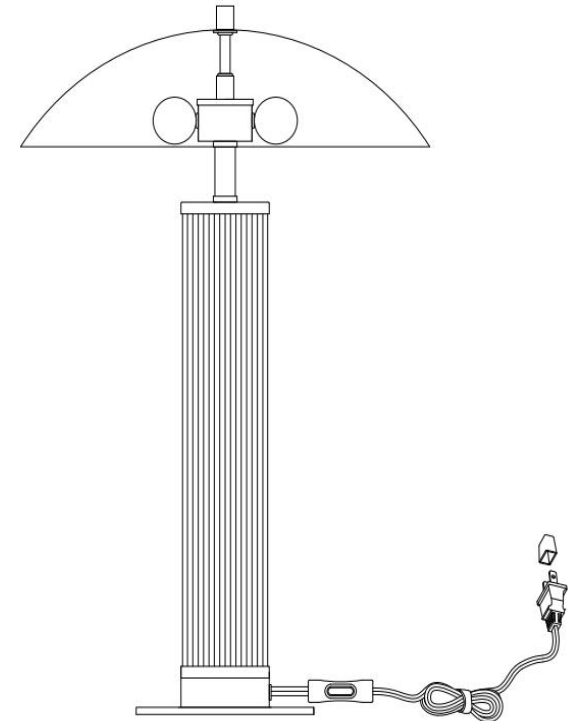

Step 1:Unpack all parts from cartons carefully.Insert the Tube (B) into the Lamp base(A).Put the Gasket(C) and shade(D) on the Tube(B), then tighten the Finial (E)into the Tube (B).

Step2:Insert the bulb(F) into the socket.

Step3:Put the light on a level surface to check if everything is stable.