

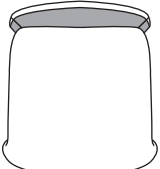

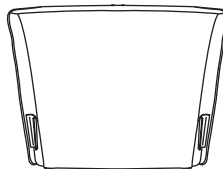

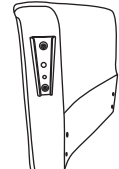
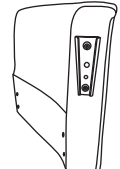
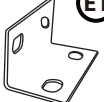

USER MANUAL
Armchair
SKU:XXXXXXX

Attention: This instruction contains important safety information, Please carefully read it and keep it for future reference.

Parts List

Make sure all the parts are in the package

<p>A x1pcs</p>  <p>Seat</p>	<p>B x1pcs</p>  <p>Backrest</p>	<p>C x1pcs</p>  <p>Left Armrest</p>	<p>D x1pcs</p>  <p>Right Armrest</p>	<p>E1 x2pcs</p>  <p>Right Angle Iron</p>
<p>F x2pcs</p>  <p>Leg-front</p>	<p>G x2pcs</p>  <p>Leg-behind</p>	<p>H x16pcs</p>  <p>M8x30mm</p> <p>Screw</p>	<p>I x2pcs</p>  <p>Foot Pad</p>	<p>E2 x2pcs</p>  <p>Obtuse Angle Iron</p> <p>J x4pcs</p>  <p>Gasket</p>

Assembly Steps

 Try not to install with 

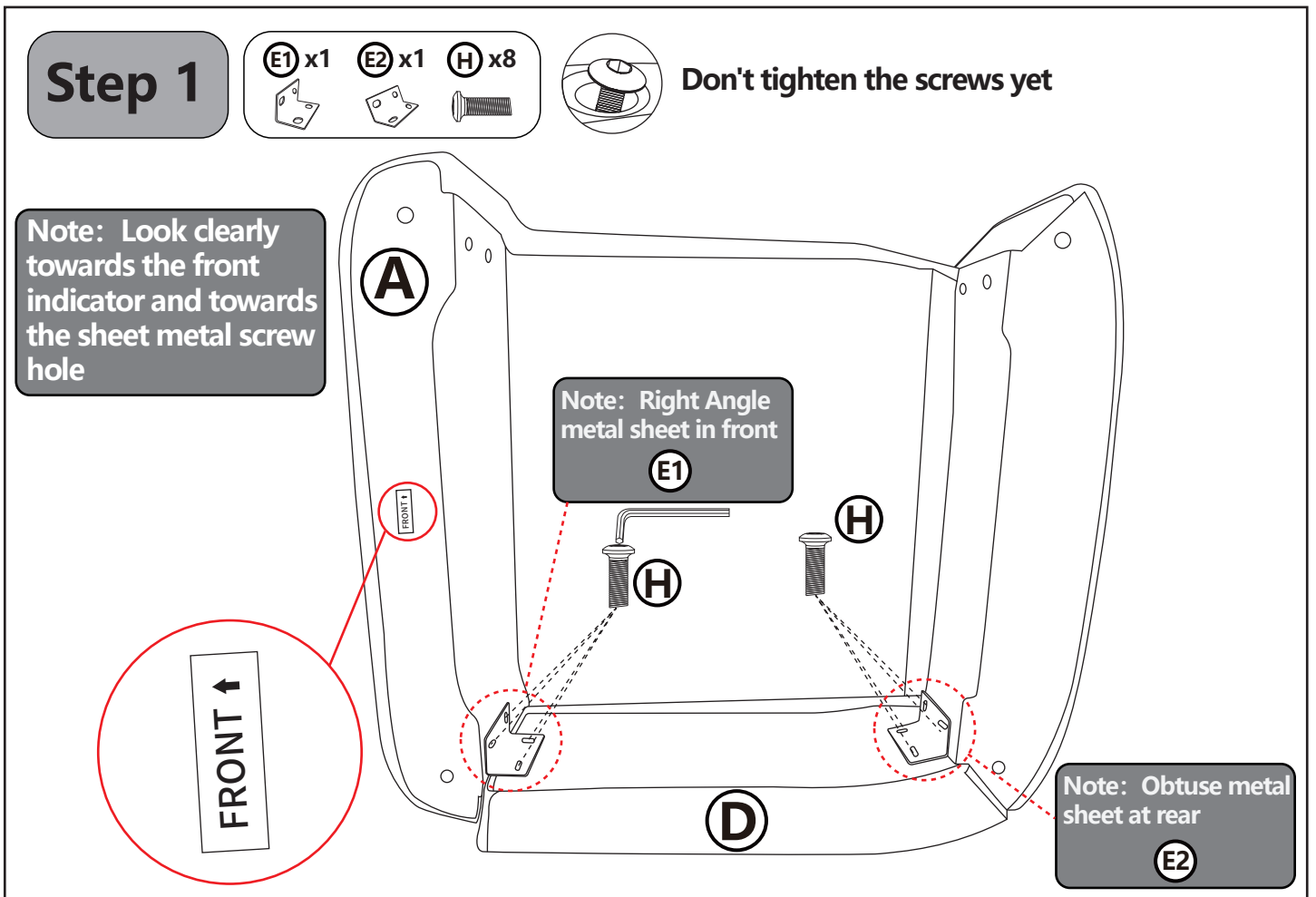

Assembly Steps

Step 2

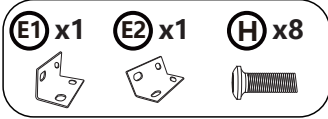

Tighten all screws

Note: The bottom of the backrest and armrest should be aligned at the same level

Note: Obtuse metal sheet at rear

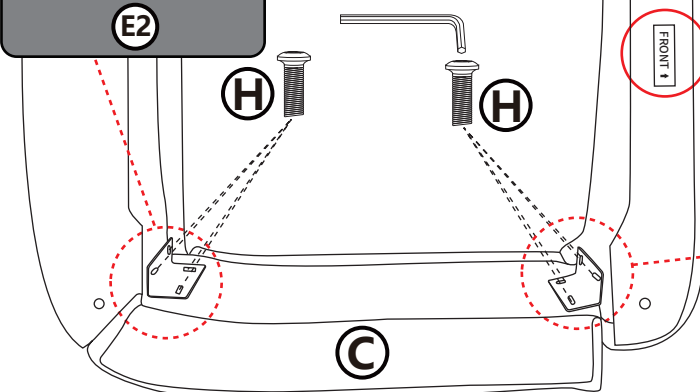

Note: Right Angle metal sheet in front

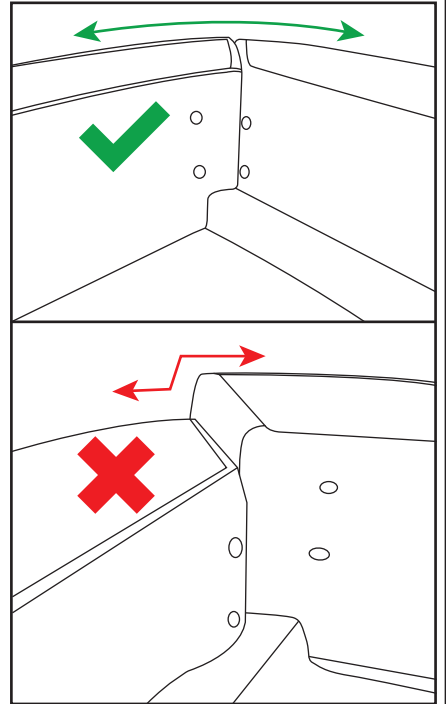

Step 3

Note: Install the back metal sheet and seat metal sheet in the same direction

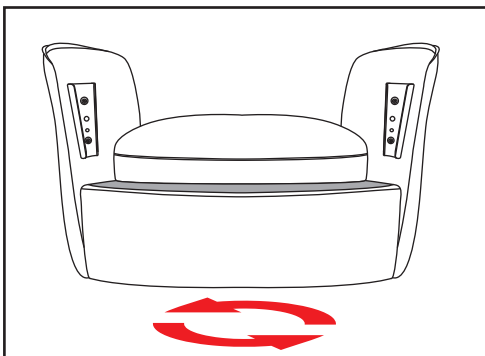

Note: Squeeze both sides of the armrest with your hands before inserting it into the backrest

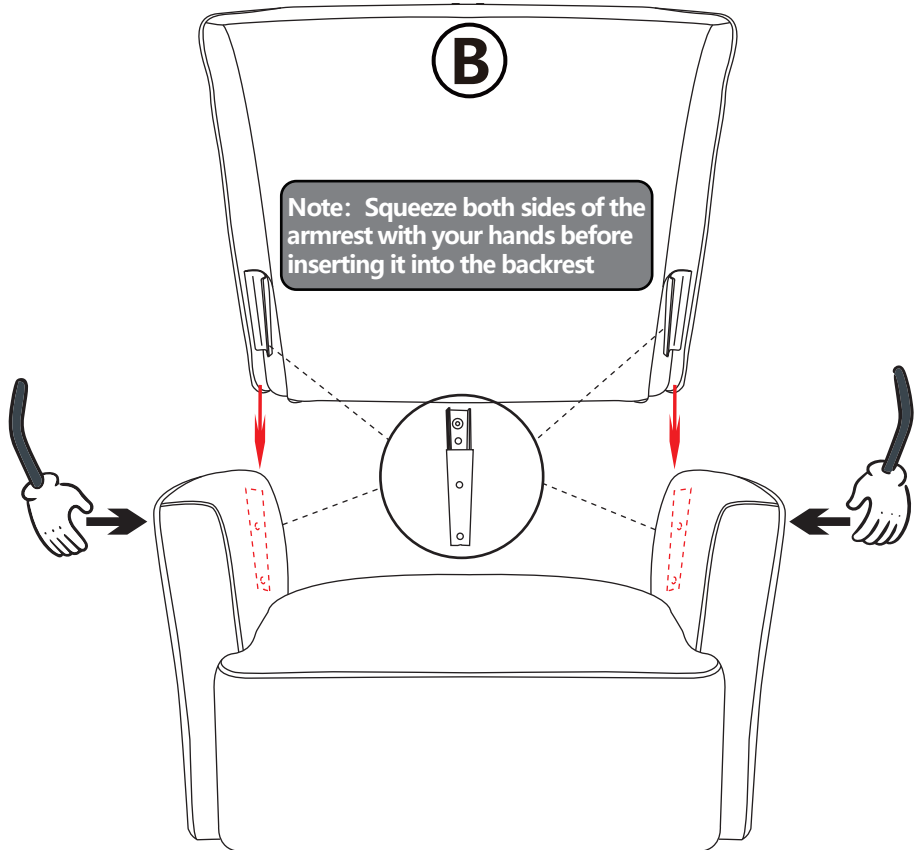

Step 4

(F) x2 (G) x2 (I) x2 (J) x4

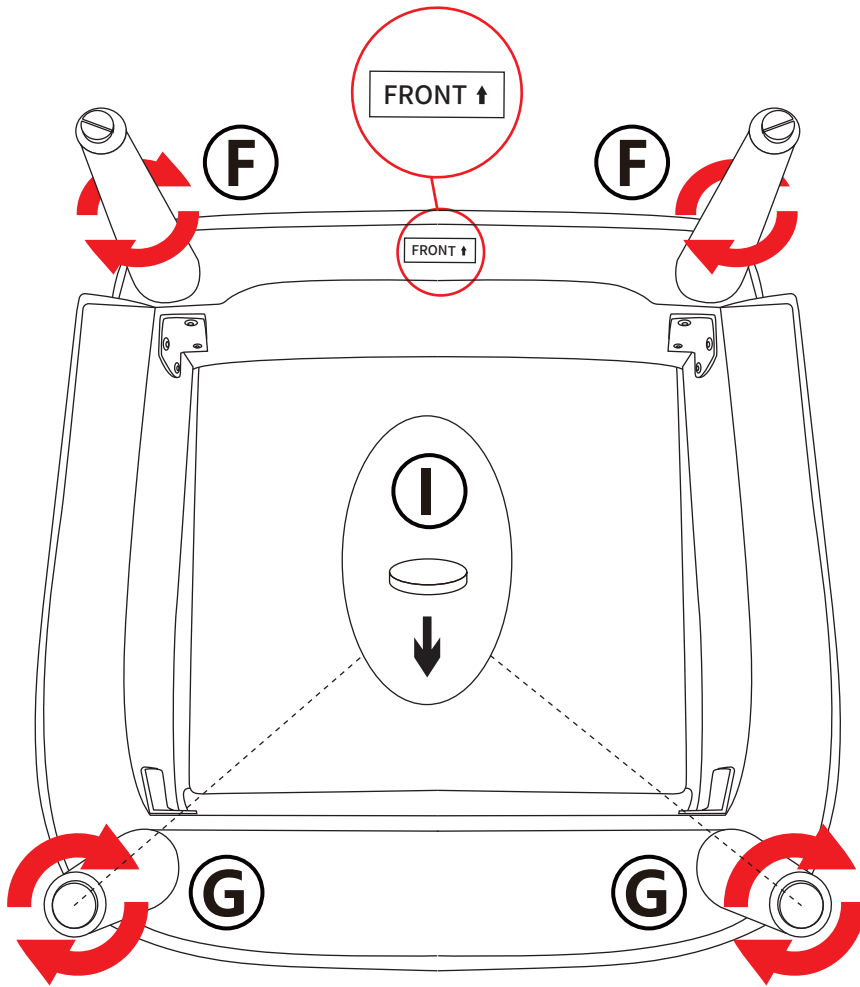

Note: Each wooden leg needs to be fitted with a gasket and then rotated

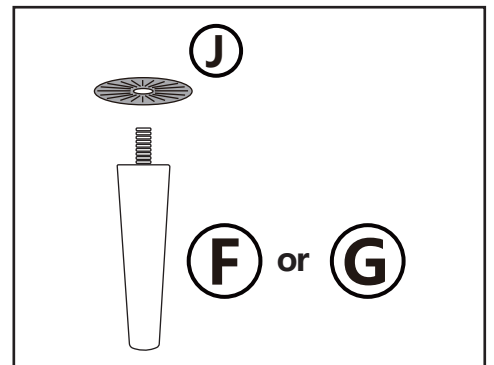

Finish

