

ASSEMBLY INSTRUCTIONS

TWIN/TWIN SIZE BUNK BED

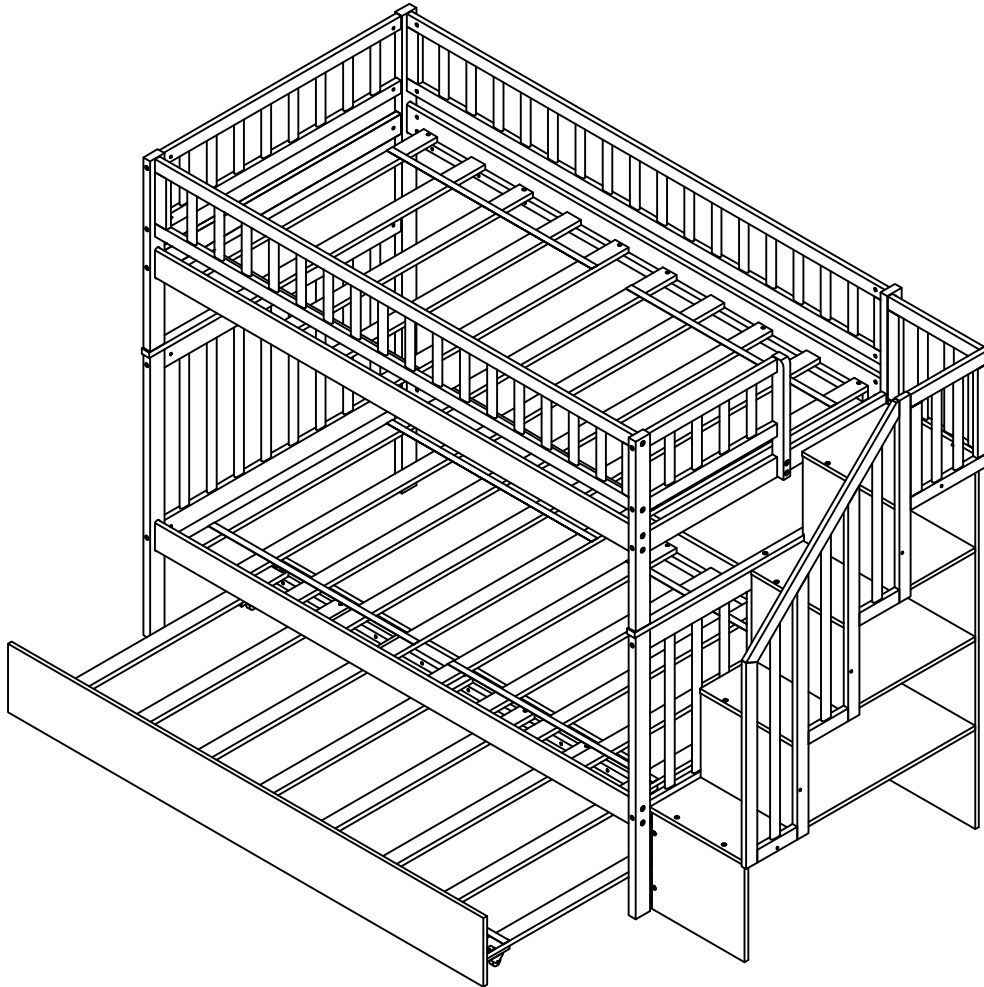





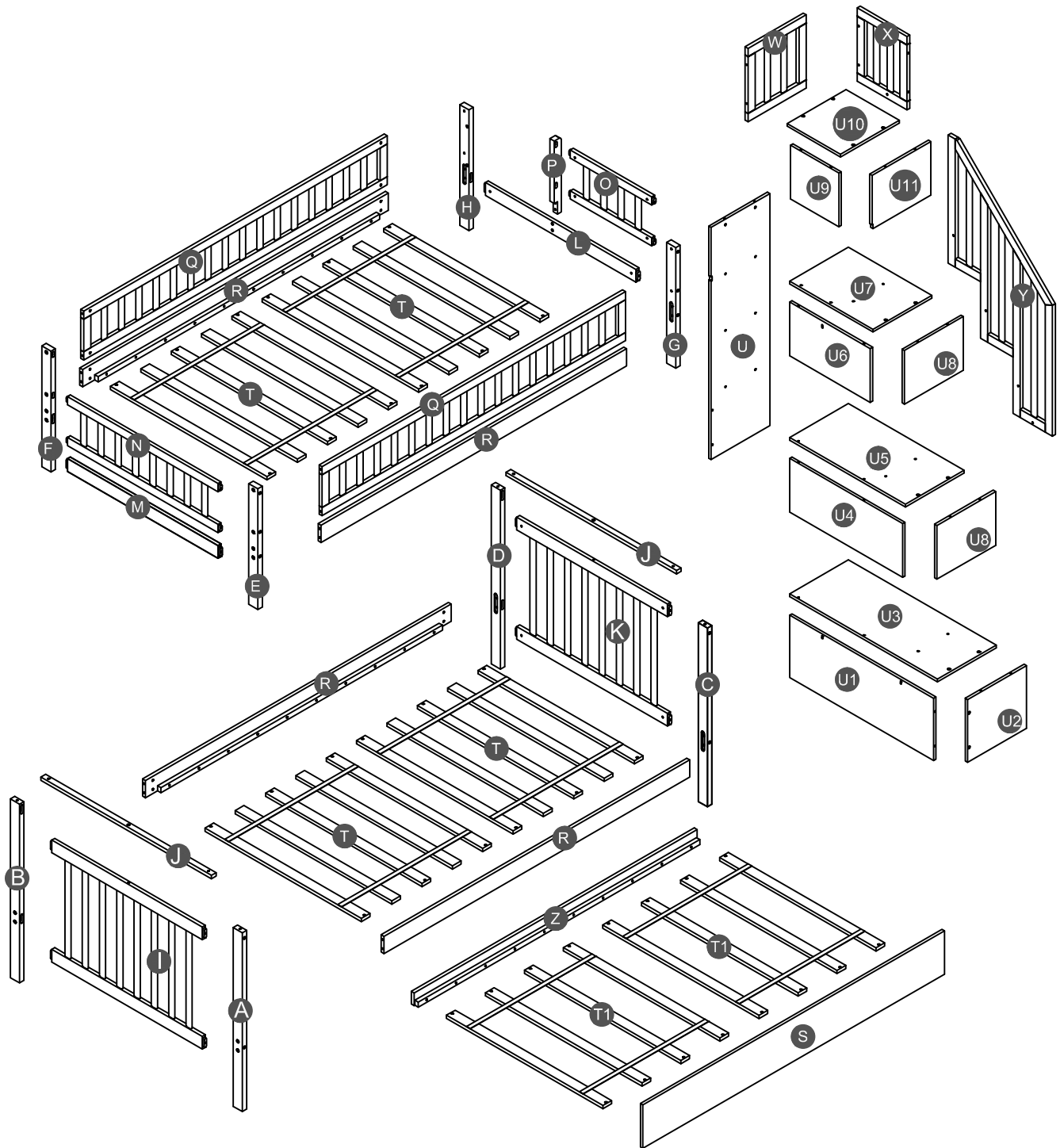



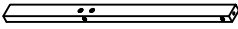
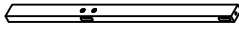
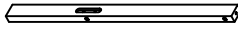
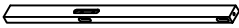

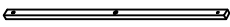
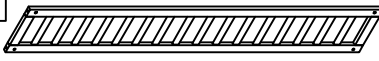

This set is included 3 boxes if don't receive full 3 boxes please contact our customer service team.

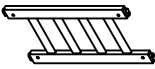
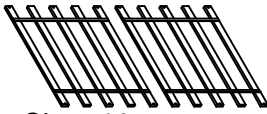
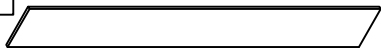
Detail View



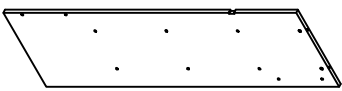
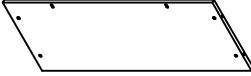
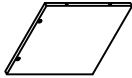
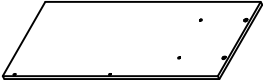

Part List

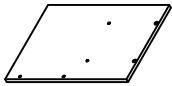
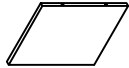
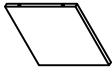
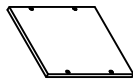
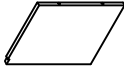



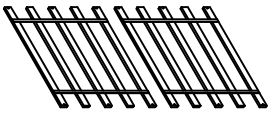
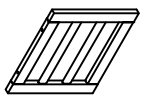
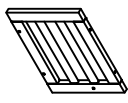
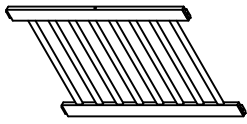
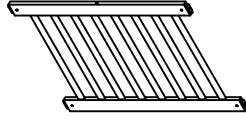

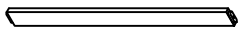
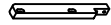
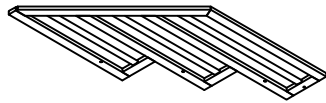
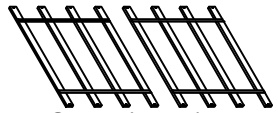



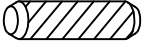
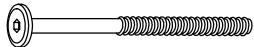
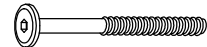
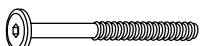



A  Lower leg(Left front) - 1pc	B  Lower leg (Right back)- 1pc	C  Lower leg(Right front) - 1pc
D  Lower leg (Left back)- 1pc	E  Upper leg(Left front) - 1pc	F  Upper leg(Right back) - 1pc
G  Upper leg (Right front)- 1pc	H  Upper leg (Left back)- 1pc	J  Cap for lower HB&FB-2pcs
Q  Upper front & back side rail-2pcs	R  Lower&upper side rail - 4pcs	N  Upper HB - 1pc
O  Upper FB - 1pc	T  Upper Slat - 10pcs	S  Trundle front panel - 1pc
Z  Trundle back panel - 1pc		

U  Back panel - 1pc	U1  Lower left side panel - 1pc	U2  Lower front panel - 1pc
U3  Lower step ladder panel - 1pc	U4  Lower left side panel - 1pc	U5  Lower step ladder panel - 1pc
U6  Lower left side panel - 1pc	U7  Lower step ladder panel - 1pc	U8  Lower front panel - 2pcs
U9  Upper left side panel - 1pc	U10  Upper step ladder panel - 1pc	U11  Upper front panel - 1pc

Part List

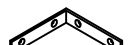
<p>T</p>  <p>Lower Slat - 10pcs</p>	<p>W</p>  <p>Upper guard back - 1pc</p>	<p>X</p>  <p>Upper guard side - 1pc</p>
<p>I</p>  <p>Lower HB - 1pc</p>	<p>K</p>  <p>Lower FB - 1pc</p>	<p>L</p>  <p>Horizontal upper bar FB-1pc</p>
<p>M</p>  <p>Horizontal upper bar HB-1pc</p>	<p>P</p>  <p>Support guard rail - 1pc</p>	<p>Y</p>  <p>Guard side - 1pc</p>
<p>T1</p>  <p>Trundle Slat - (8pcs)</p>		

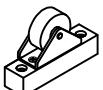
Hardware List

1  Ø8*30mm Wood dowel (12pcs)	2  (Ø15)1/4"*100mm Hex-Head bolts (18pcs)	3  (Ø15)1/4"*80mm Hex-Head bolts (24pcs)
4  (Ø12)1/4"*70mm Hex-Head bolts (2pcs)	5  (Ø12)1/4"*60mm Hex-Head bolts (37pcs)	6  (Ø12)1/4"*35mm Hex-Head bolts (2pcs)
7  (Ø12)1/4"*30mm Hex-Head bolts (3pcs)	8  1/4"*15 (9.5mm) Horizontal-Hole bolts (79pcs)	9  Ø9*90mm Connecting bar (4pcs)
10  (Ø12)1/4"*40mm Hex-Head bolts (2pcs)	11  (1/4")4.5*58mm Allen key (1pc)	12  Ø4*30mm Wood screws (48pcs)
13  Ø1/4"*19*2mm Flat Washer (3pcs)	14  95*95*18*3mm Metal bracket (2pcs)	15  Ø3.5*15mm Wood screws (16pcs)
16  100*63*20mm Wheels (4pcs)	17  40*18*18*2mm Metal bracket (2pcs)	

ASSEMBLY TOOLS REQUIRED (NOT INCLUDED)

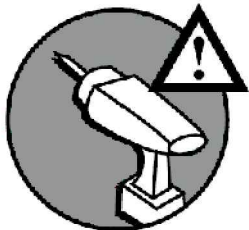
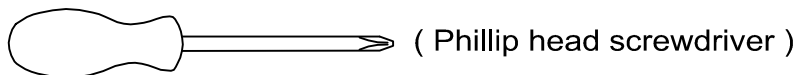



DO NOT USE POWER TOOLS TO ASSEMBLE THIS PRODUCT !

Remark: We recommend you assemble your bed in the flat ground.

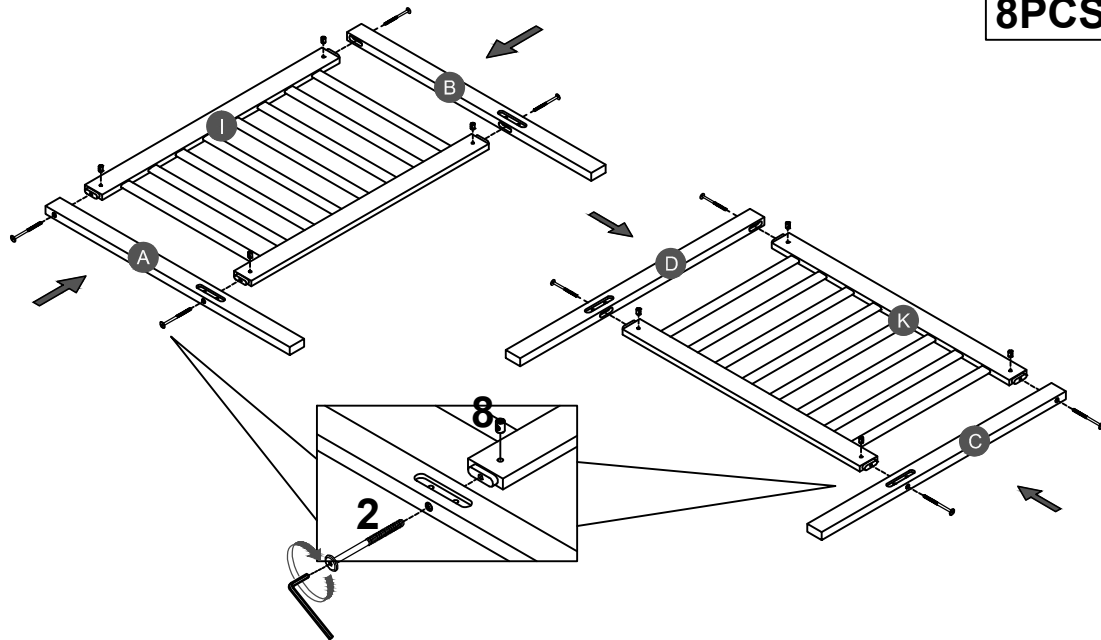

STEP 1:





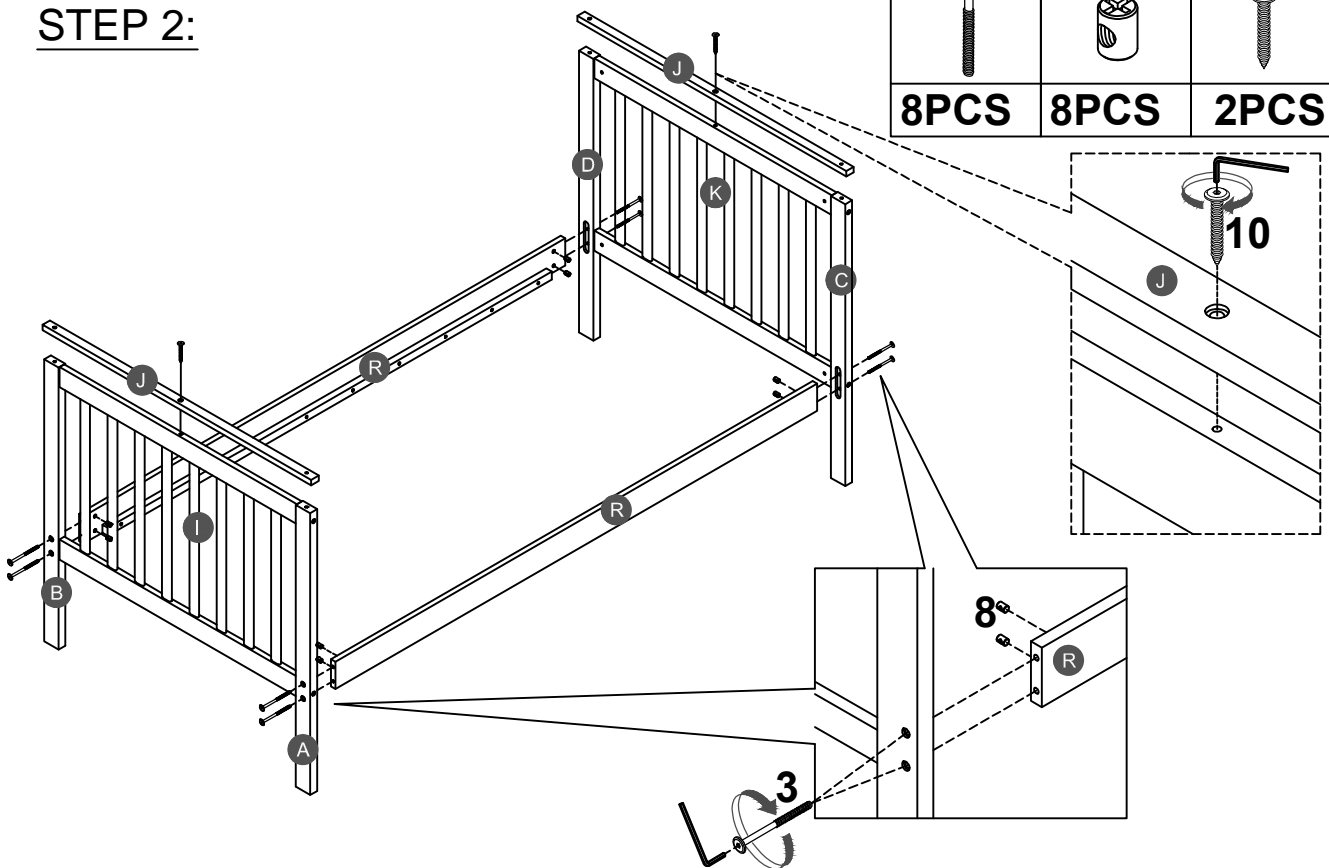

2		8	
8PCS		8PCS	

STEP 2:



3		8		10	
8PCS		8PCS		2PCS	

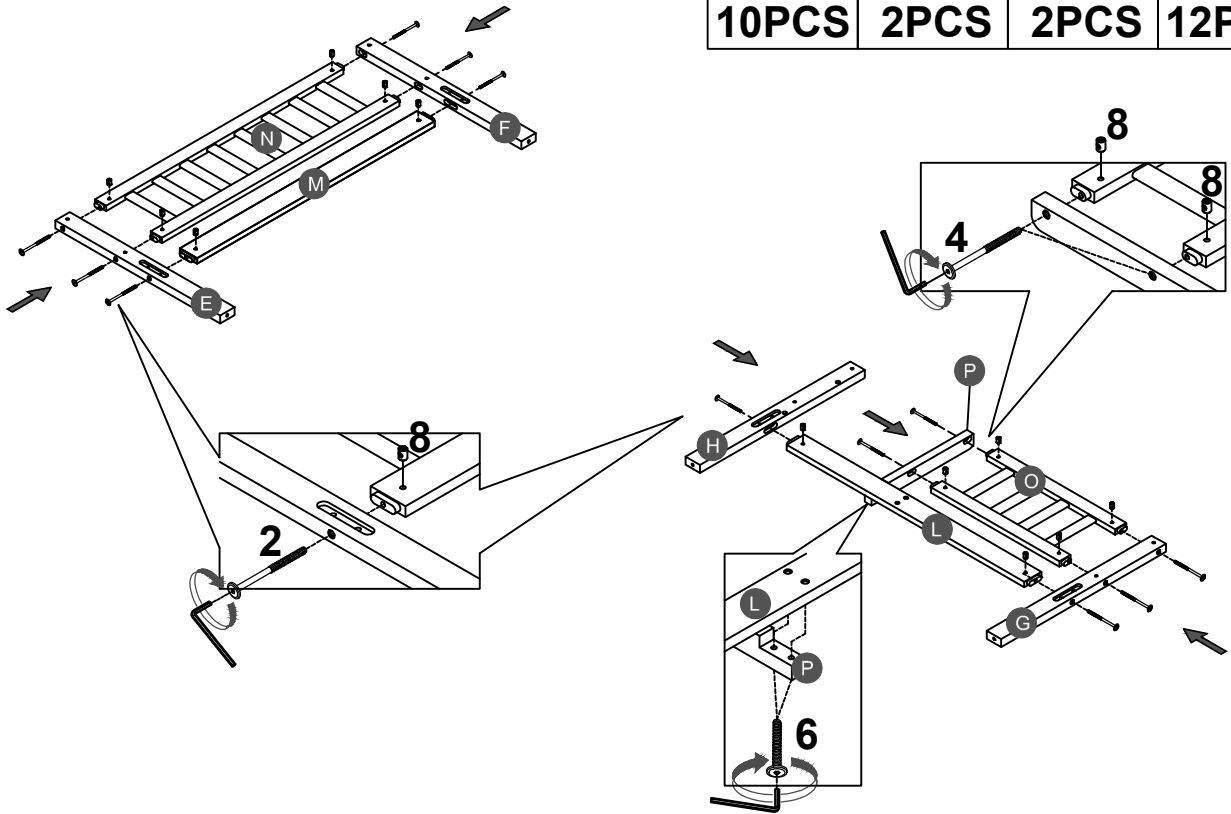

STEP 3:

2		4		6		8	
10PCS		2PCS		2PCS		12PCS	



STEP 4:

Balcony don't tighten these yet . Leave them a bit loose to make fitting the lower side rail more easily.

3		8	
16PCS		16PCS	

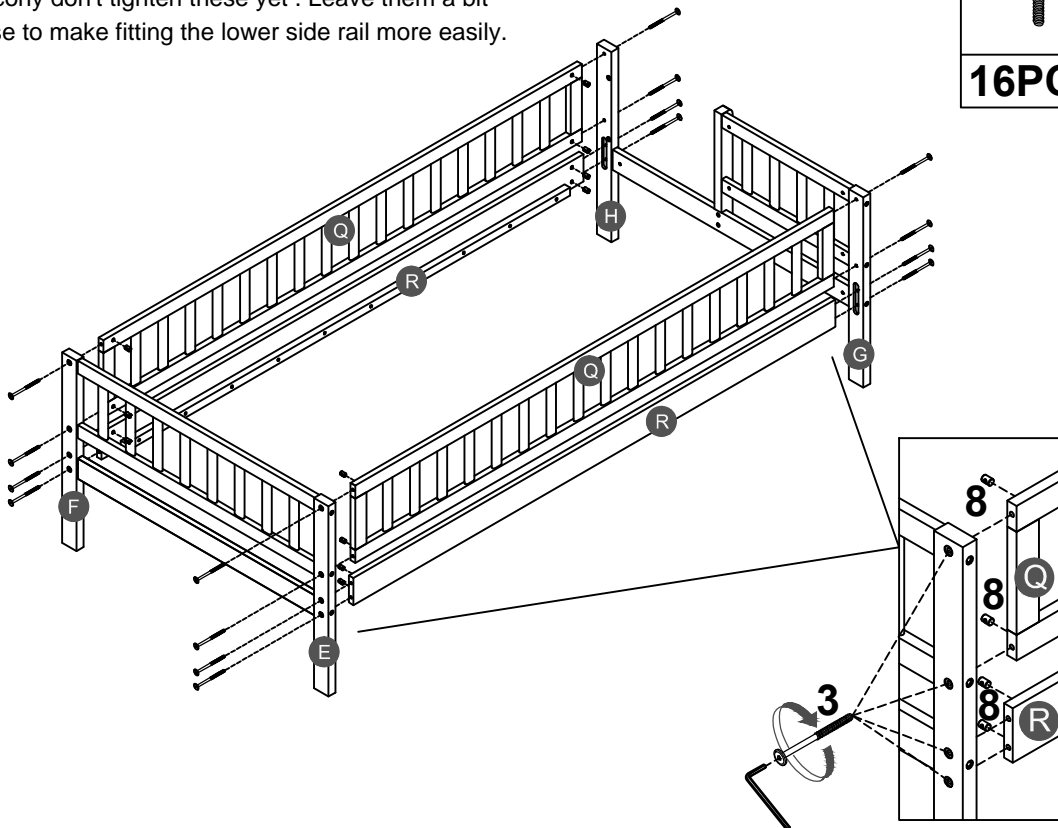

STEP 5:



9

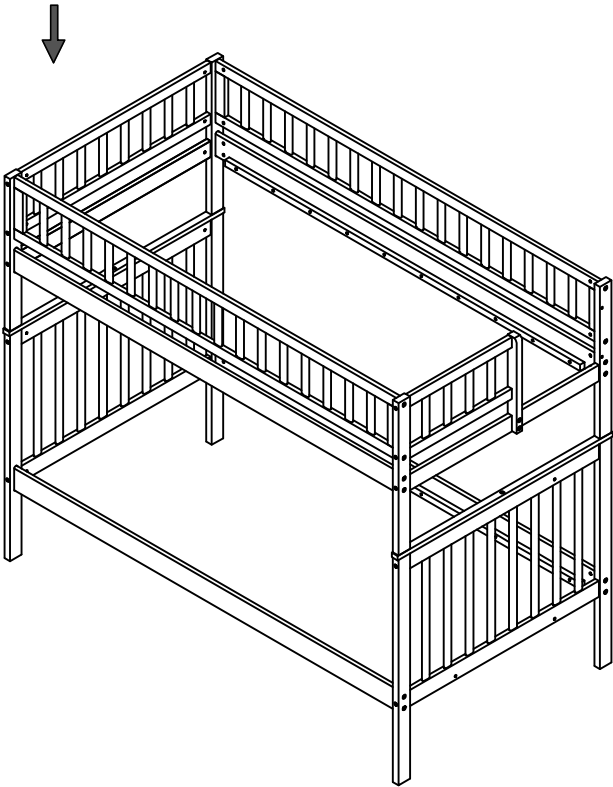
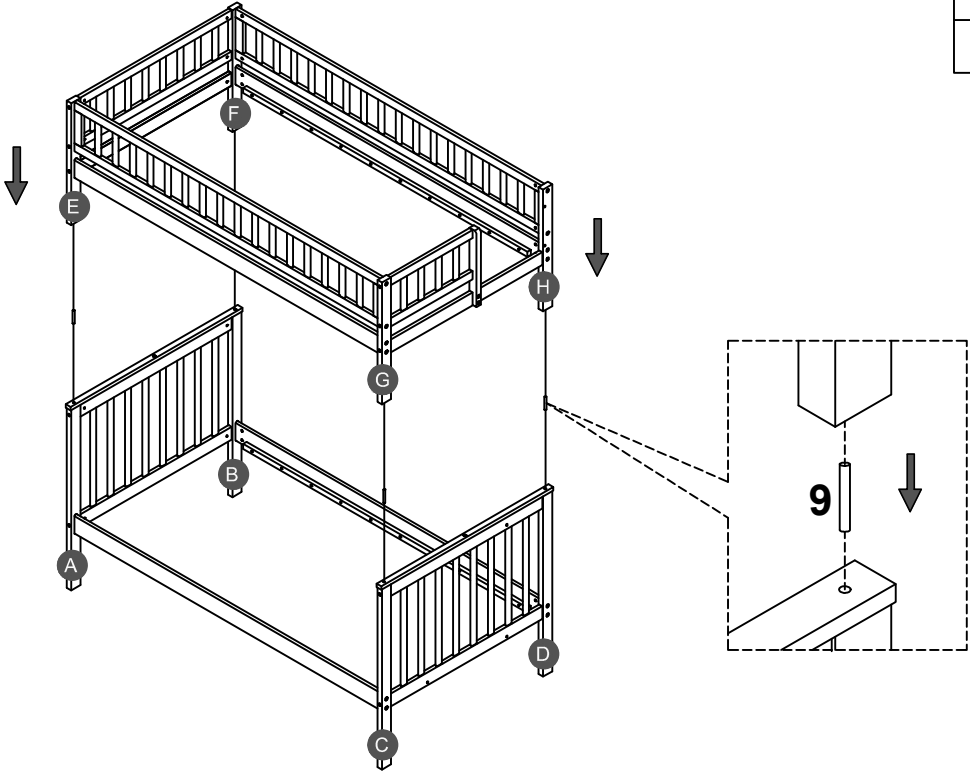

4PCS





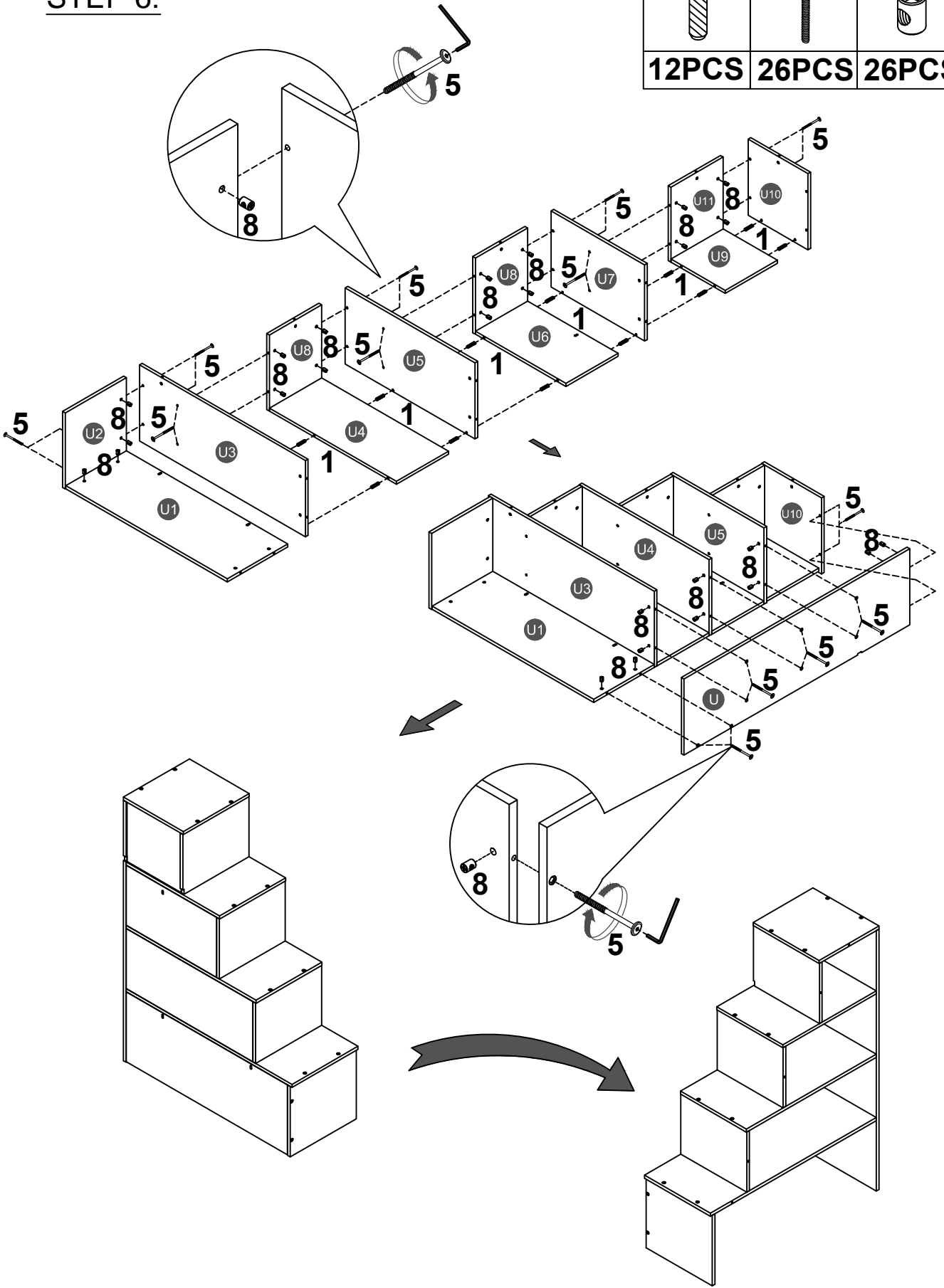

STEP 6:

1		5		8	
12PCS		26PCS		26PCS	



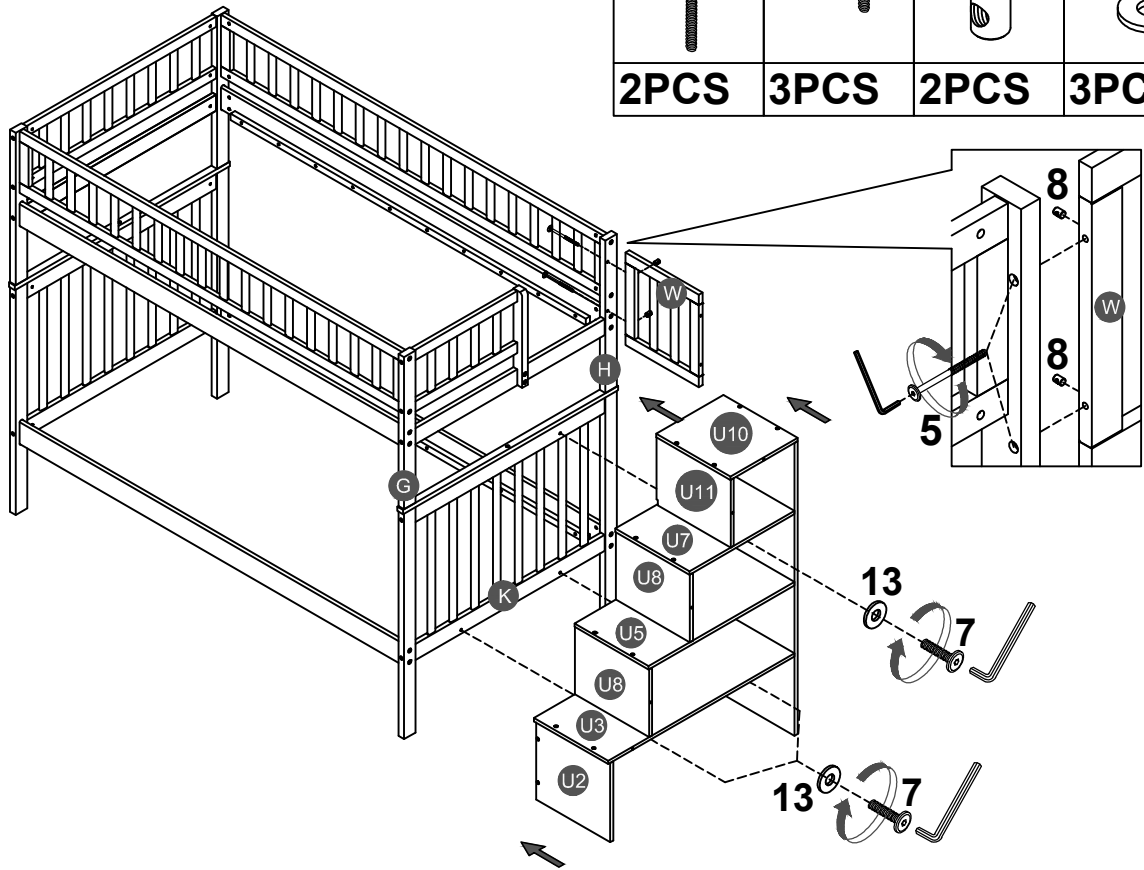

STEP 7:

5		7		8		13	
2PCS		3PCS		2PCS		3PCS	



STEP 8:

5		8	
9PCS		7PCS	

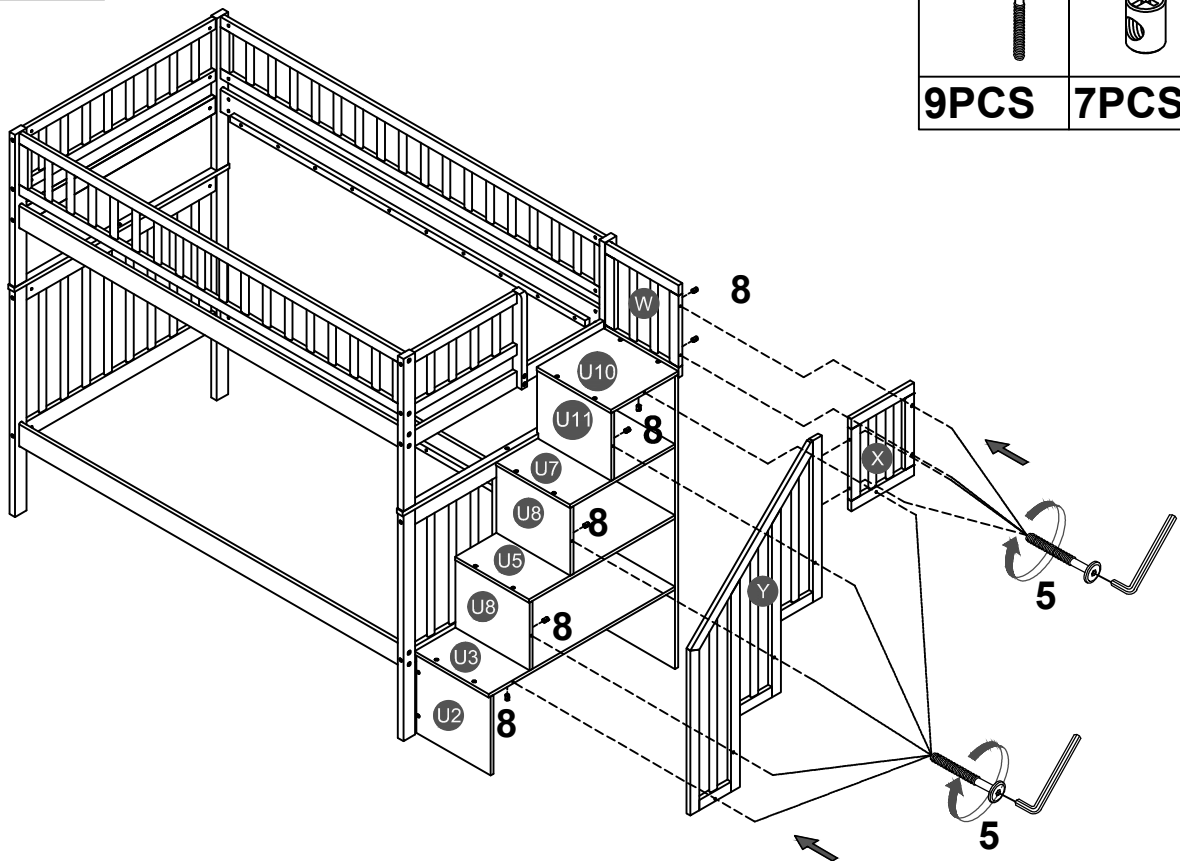

STEP 9:



12

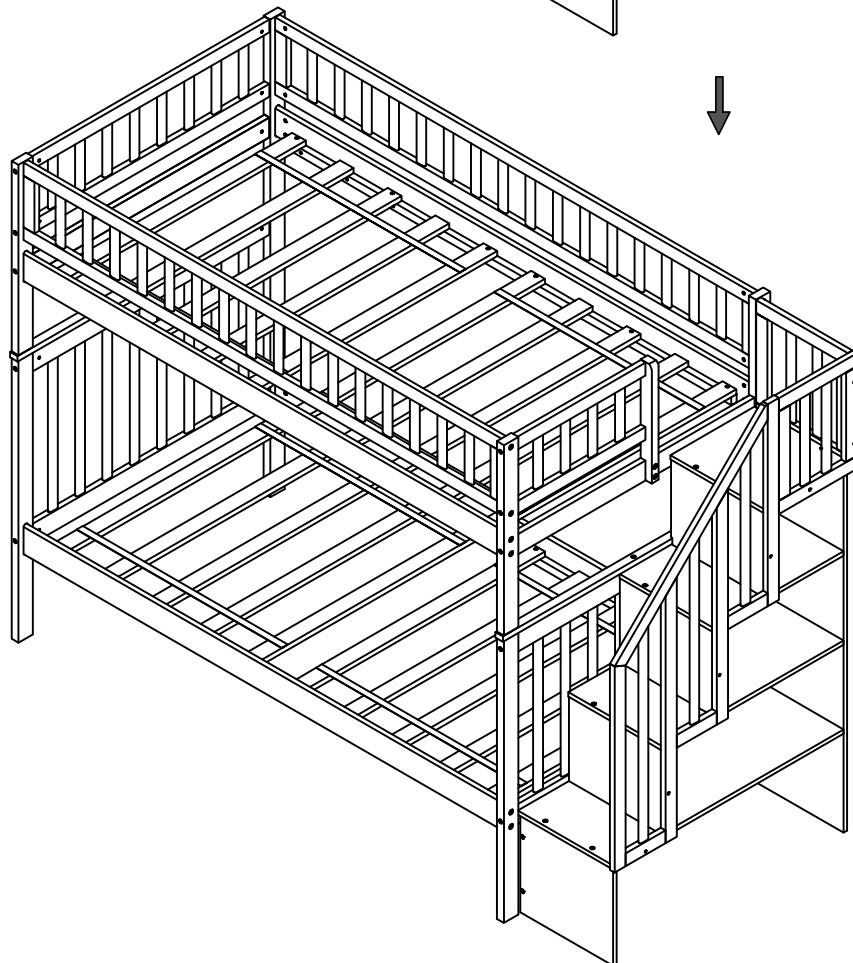
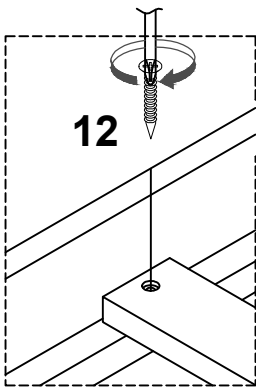
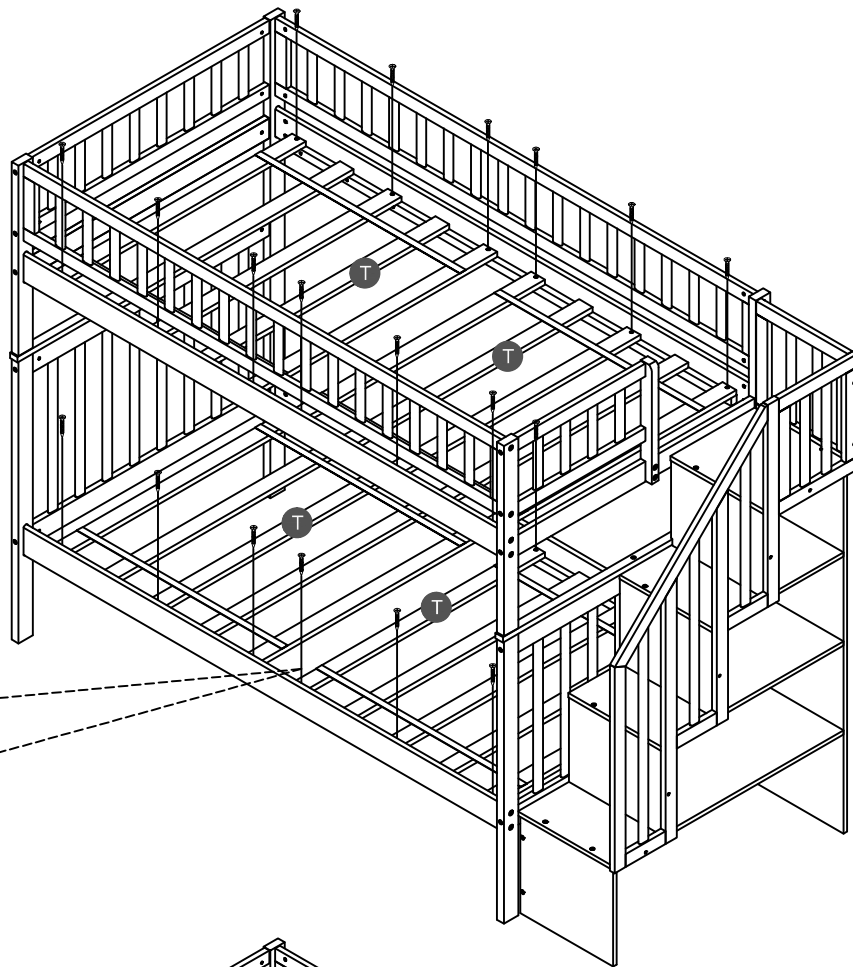

24PCS



STEP 10:

16 	12 
4PCS	8PCS

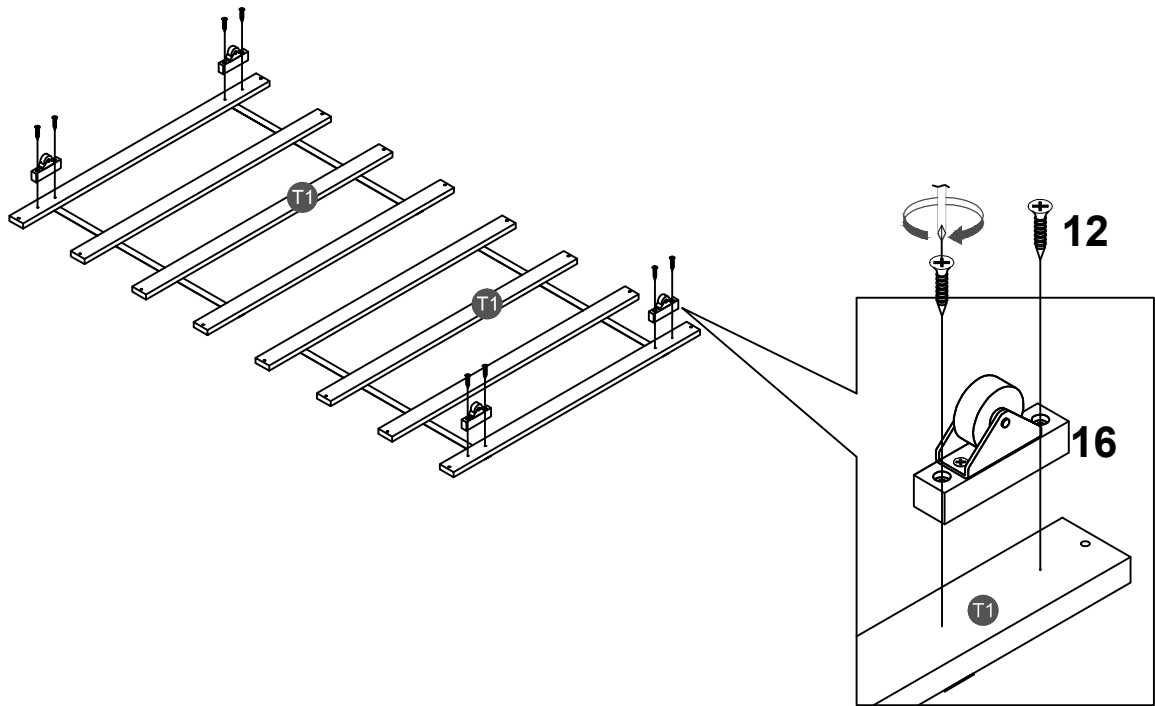

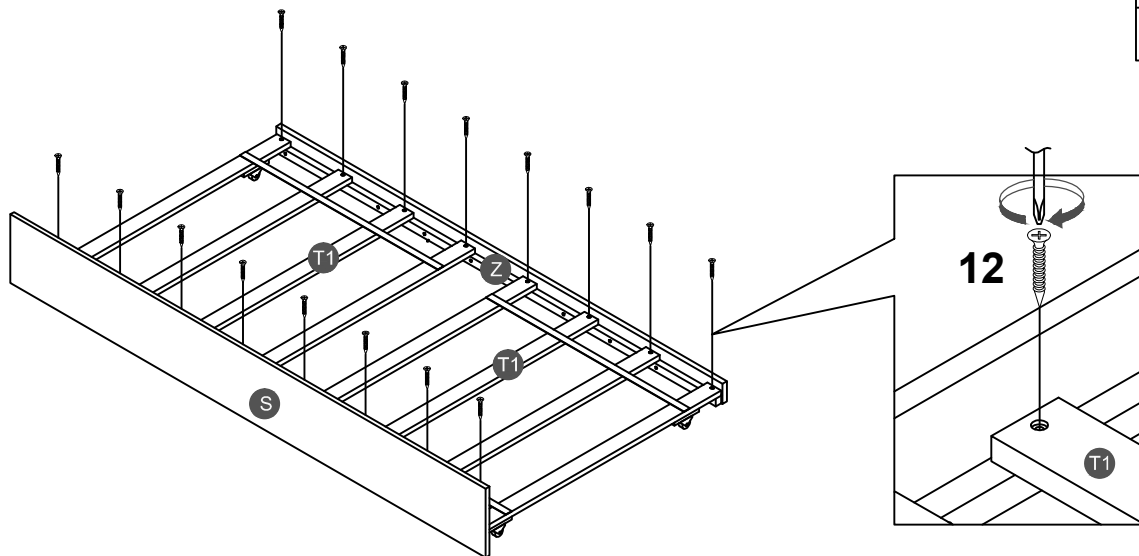

STEP 11:

12 
16PCS



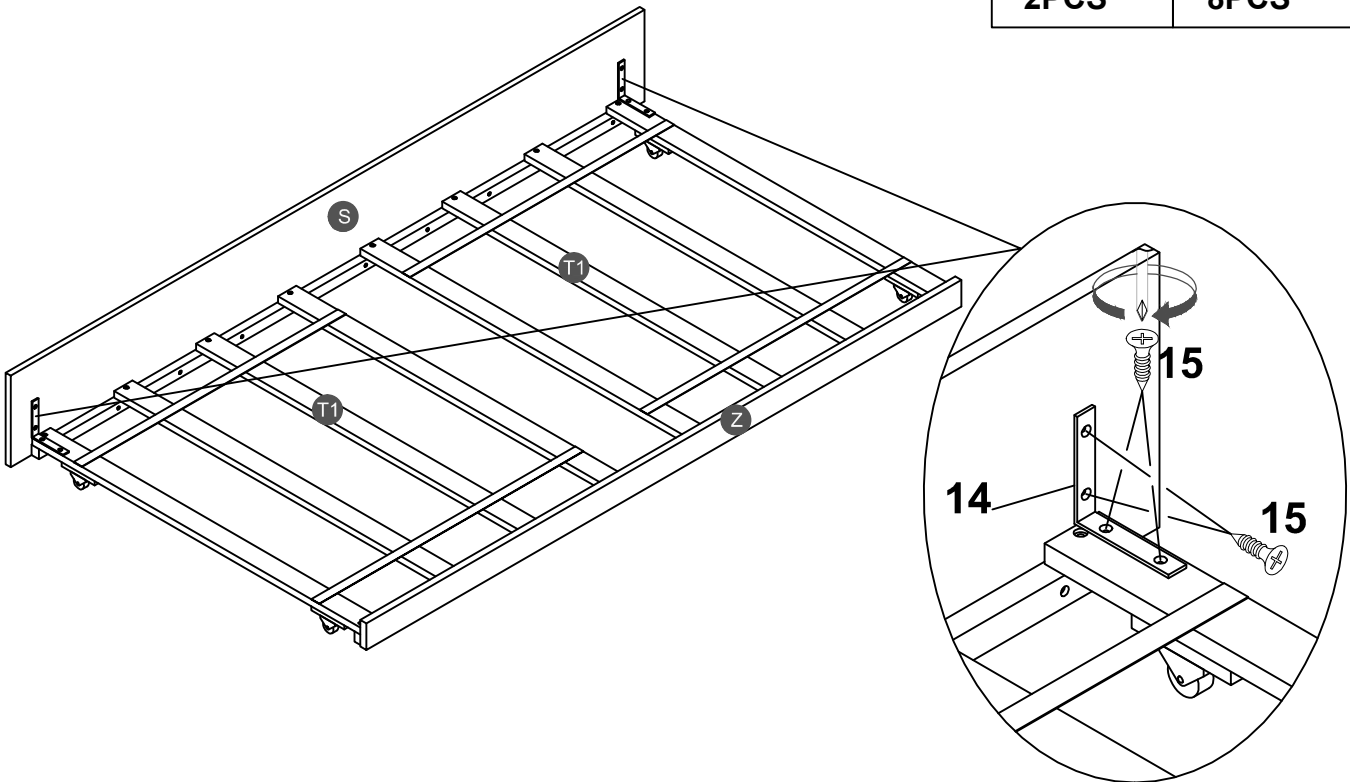

STEP 12:

14 	15 
2PCS	8PCS



STEP 13:

15 	17 
8PCS	2PCS

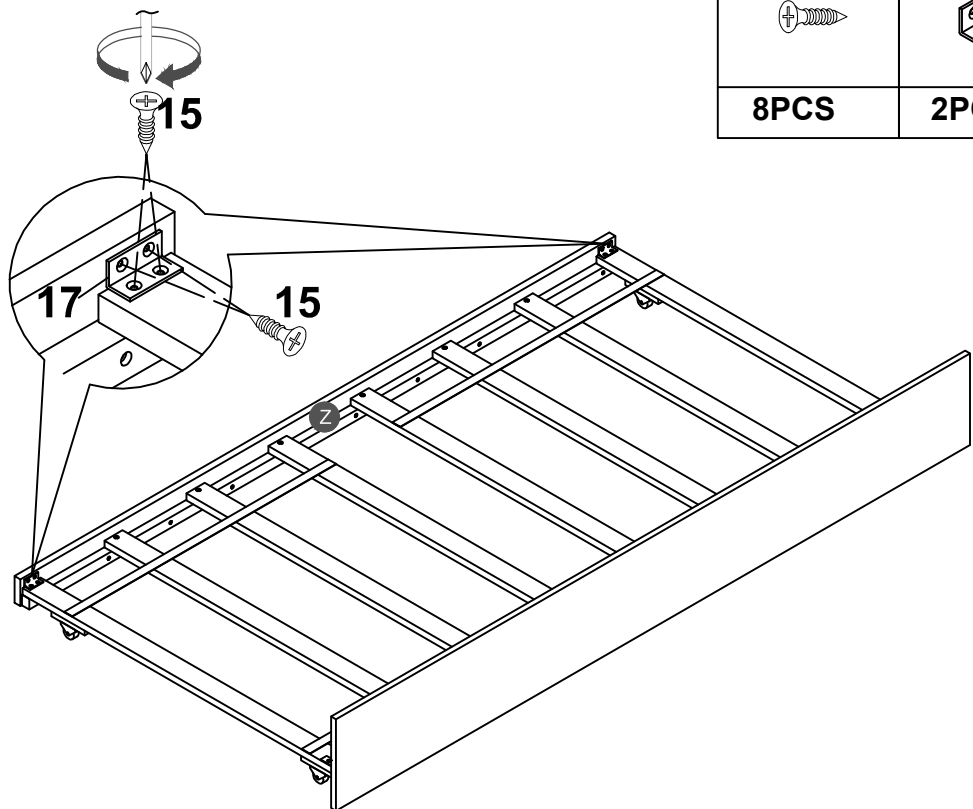

STEP 14:

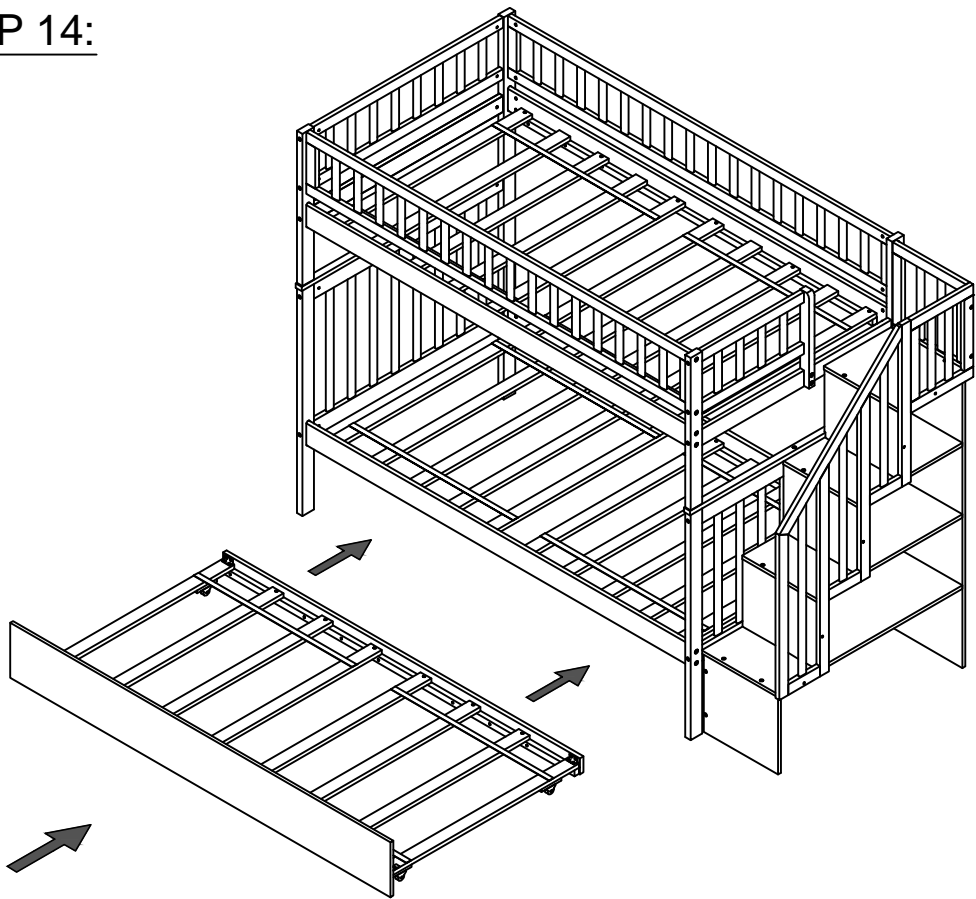

Push Trundle under the bottom of Bunkbed.

