

Glass Care and Cleaning

Label is to be removed by the consumer only.

Étiquette doit être éliminée par le seul consommateur.

If glass is chipped or broken, stop using the product and consult a retail store.

Si le verre est ébréché ou cassé, cessez d'utiliser le produit et consultez un magasin de détail.

Warning-Avertissement

- 1. Do not place very hot or cold items on glass surface(s), unless adequately thick table mats are used, to prevent such items from coming in contact with glass.**

Ne placez pas d'objets très chauds ou très froids sur la surface en verre(s), à moins que suffisamment épais tapis de table sont utilisés, pour empêcher ces éléments d'entrer en contact avec le verre.

- 2. Do not sit or stand upon horizontal glass surface(s).**

Ne restez pas assis ou debout sur la surface de verre horizontale(s).

- 3. Do not use the glass as a chipping surface. Do not strike the glass with hard or pointed items.**

N'utilisez pas le verre comme une surface à d'écaillage.

- 4. When cleaning glass, use a damp cloth. Do not use abrasive powders or any other substances containing abrasives as these can scratch the surface.**

Lorsque vous nettoyez le verre utilisez un chiffon humide. N'utilisez pas de poudres abrasives ou d'autres substances contenant des abrasifs, car elles peuvent rayer la surface.

- 5. NEVER put a TV on this product.**

Ne JAMAIS placer un téléviseur sur ce produit.

ASSEMBLY INSTRUCTIONS INSTRUCTIONS DE MONTAGE INSTRUCCIONES DE MONTAJE

END TABLE









CAUTION: PLEASE READ ALL INSTRUCTIONS BEFORE STARTING THE ASSEMBLY OF THIS PRODUCT. THESE PIECES ARE HEAVY. IN ORDER TO PREVENT PERSONAL INJURY AND ENSURE THAT THIS PRODUCT IS NOT DAMAGED DURING THE ASSEMBLY PROCESS, IT IS STRONGLY RECOMMENDED TO ENLIST THE ASSISTANCE OF ONE OR MORE PERSONS. IN CASE OF EXCESS STAIN, WIPE THE BOTTOM OF THE UNIT BEFORE PLACING ON ANY SURFACE.

ATTENTION: VEUILLEZ LIRE TOUTES LES INSTRUCTIONS AVANT DE COMMENCER L'ASSEMBLAGE DE CE PRODUIT. LES PIECES SONT LOURDES. POUR EVITER TOUTE BLESSURE ET POUR VOUS ASSURER QUE LE PRODUIT N'EST PAS ENDOMMAGE' PENDANT L'ASSEMBLAGE, NOUS VOUS RECOMMANDONS DE FAIRE APPEL A UNE OU PLUSIEURS AUTRES PERSONNES. EN CAS DE TACHE EXCESSIVE, ESSUYEZ LE FOND DE L'UNITE' AVANT LE PLACEMENT SUR N'IMPORTE QUELLE SURFACE.





CUIDADO: FAVOR DE LEER TODAS LAS INSTRUCCIONES ANTES DE ENSAMBLAR SU PRODUCTO, ESTAS. PIEZAS SON PESADAS. PARA PREVENIR HERIDAS PERSONALES Y ASEGURAR QUE SU PRODUCTO NO SEA DANADO MIENTRAS ES ENSAMBLADO. SE RECOMIENDA LA ASISTENCIA DE UNA O MAS PERSONAS.

WARNING: PROTECTIVE GLIDE IS PLACED UNDER EACH LEG OF THE FURNITURE TO RESIST SCRATCHES ON FLOOR SURFACE. SOME FLOOR SURFACES CAN BE EXTRA SENSITIVE TO SCRATCHES AND MARKINGS, IF YOU ARE NOT SURE CONSULT WITH YOUR DEALER.
AVERTISSEMENT. LES PIEDS DES MEUBLES SONT MUNIS DE PATINS DESTINES A PROTEGER LE PLANCHER. CERTAINS REVETEMENTS DE SOL PEUVENT ETRE TRES FRAGILES. EN CAS DE DOUTE. CONSULTER LE MARCHAND.

LIST OF PARTS AND HARDWARE/ LISTE DES PIÈCES ET DU MATÉRIEL/ LISTA DE PIEZAS Y HARDWARE

NO#/ NOMBRE/ NÚMERO	DESCRIPTION/ DESCRIPTION/ DESCRIPCIÓN	QUANTITY/ QUANTITÉ/ CANTIDAD
A	FLAT WASHER/ RONDELLE PLATE/ 5/16" DIAMETER x 3/4" x 1/16" 	4 PCS
B	LOCK WASHER/ RONDELLE DE BLOCAGE/ARANDELA DE BLOQUEO 5/16" DIAMETER x 1/2"x 1/16" 	4 PCS
C	BOLT/ BOULON/ TORNILLO 5/16"DIAMETER x 1-5/8 " LENGTH 	3 PCS
D	BOLT/ BOULON/ TORNILLO 5/16"DIAMETER x 1.3/8" LENGTH 	1 PC
E	BOLT/ BOULON/ TORNILLO 1/4"DIAMETER x 3/4 " LENGTH 	6 PCS
F	FLAT WASHER/ RONDELLE PLATE/ 1/4" DIAMETER x 3/4" 	6 PCS
G	LOCK WASHER/ RONDELLE DE BLOCAGE/ARANDELA DE BLOQUEO 1/4" DIAMETER x 3/8" 	6 PCS
H	PATT METAL/ PATTE MÉTAL/PATRÓN DE METAL 	1 PC
I	ALLEN KEY/ CLÉ ALLEN/LLAVE INGLESA ALLEN 5/32" 	1 PC

LIST OF PARTS AND HARDWARE/ LISTE DES PIÈCES ET DU MATÉRIEL/ LISTA DE PIEZAS Y HARDWARE

NO#/ NOMBRE/ NÚMERO	DESCRIPTION/ DESCRIPTION/ DESCRIPCIÓN	QUANTITY/ QUANTITÉ/ CANTIDAD
1	TOP GLASS/ VERRE SUPÉRIEUR/ VIDRIO SUPERIOR 	1 PC
2	LEG FRAME/ CADRE DE JAMBES/ MARCO DE PIERNAS 	1 PC
3	LEG L/ JAMBE L/ PIERNA L 	1 PC
4	STRETCHER SUPPORT GLASS/ SUPPORT DE CIVIÈRE EN VERRE / SOPORTE CAMILLA VIDRIO 	1 PC

NOTE:
ASSEMBLE UNIT ON A SOFT SURFACE.
ASSEMBLEZ L'UNITÉ SUR UNE SURFACE MOLLE.
ENSAMBLE LA UNIDAD EN UNA SUPERFICIE PLANA Y SUAWE.

DO NOT TIGHTEN BOLTS UNTIL ALL PARTS AND HARDWARE OF THE UNIT ARE ASSEMBLED.
NE SERREZ PAS LES BOULONS JUSQU'À CE QUE L'UNITÉ SOIT COMPLÈTEMENT ASSEMBLÉE.
NO APRIETE LOS TORNILLOS HASTA QUE LA UNIDAD ESTE COMPLETAMENTE ENSAMBLADA.



WARNING:
ONLY USE THE HAND
TOOLS PROVIDED

ASSEMBLY INSTRUCTIONS INSTRUCTIONS DE MONTAGE INSTRUCCIONES DE MONTAJE

END TABLE

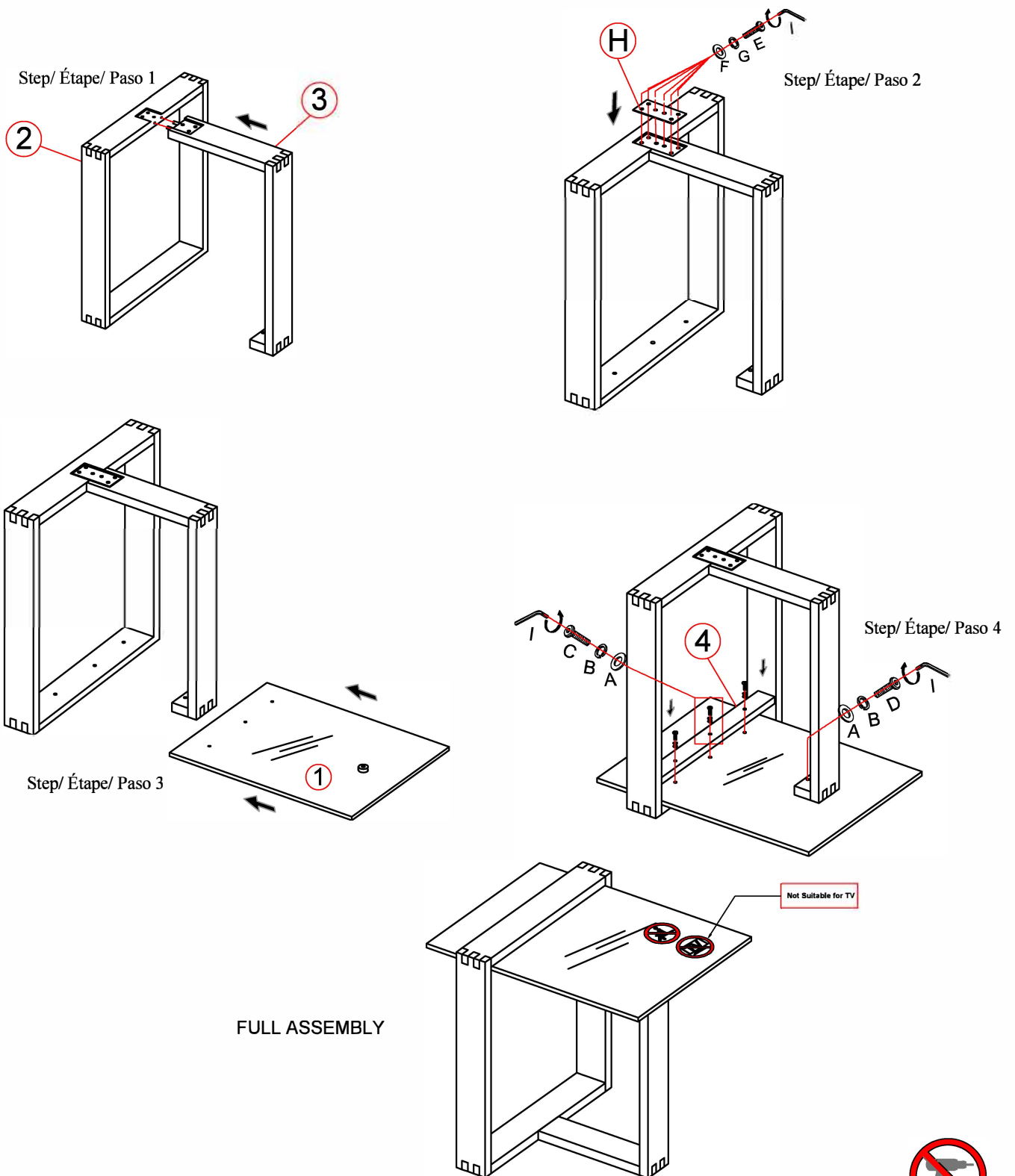

NOTE:
Spirit level not included but necessary to level product on floor.
Niveau à bulle non inclus mais nécessaire pour niveler le produit au sol.
Nivel de burbuja no incluido pero necesario para nivelar el producto en el piso.



WARNING:
ONLY USE THE HAND
TOOLS PROVIDED

ASSEMBLY INSTRUCTIONS INSTRUCTIONS DE MONTAGE INSTRUCCIONES DE MONTAJE

COCKTAIL TABLE









CAUTION: PLEASE READ ALL INSTRUCTIONS BEFORE STARTING THE ASSEMBLY OF THIS PRODUCT. THESE PIECES ARE HEAVY. IN ORDER TO PREVENT PERSONAL INJURY AND ENSURE THAT THIS PRODUCT IS NOT DAMAGED DURING THE ASSEMBLY PROCESS, IT IS STRONGLY RECOMMENDED TO ENLIST THE ASSISTANCE OF ONE OR MORE PERSONS. IN CASE OF EXCESS STAIN, WIPE THE BOTTOM OF THE UNIT BEFORE PLACING ON ANY SURFACE.

ATTENTION: VEUILLEZ LIRE TOUTES LES INSTRUCTIONS AVANT DE COMMENCER L'ASSEMBLAGE DE CE PRODUIT. LES PIÈCES SONT LOURDES. POUR ÉVITER TOUTE BLESSURE ET POUR VOUS ASSURER QUE LE PRODUIT N'EST PAS ENDOMMAGÉ PENDANT L'ASSEMBLAGE, NOUS VOUS RECOMMANDONS DE FAIRE APPEL À UNE OU PLUSIEURS AUTRES PERSONNES. EN CAS DE TACHE EXCESSIVE, ESSUYEZ LE FOND DE L'UNITÉ AVANT LE PLACEMENT SUR N'IMPORTE QUELLE SURFACE.





CUIDADO: FAVOR DE LEER TODAS LAS INSTRUCCIONES ANTES DE ENSAMBLAR SU PRODUCTO, ESTAS. PIEZAS SON PESADAS. PARA PREVENIR HERIDAS PERSONALES Y ASEGURAR QUE SU PRODUCTO NO SEA DANADO MIENTRAS ES ENSAMBLADO. SE RECOMIENDA LA ASISTENCIA DE UNA O MAS PERSONAS.

WARNING: PROTECTIVE GLIDE IS PLACED UNDER EACH LEG OF THE FURNITURE TO RESIST SCRATCHES ON FLOOR SURFACE. SOME FLOOR SURFACES CAN BE EXTRA SENSITIVE TO SCRATCHES AND MARKINGS, IF YOU ARE NOT SURE CONSULT WITH YOUR DEALER.
AVERTISSEMENT. LES PIEDS DES MEUBLES SONT MUNIS DE PATINS DESTINÉS À PROTÉGER LE PLANCHER. CERTAINS REVÊTEMENTS DE SOL PEUVENT ÊTRE TRÈS FRAGILES. EN CAS DE DOUTE. CONSULTER LE MARCHAND.

LIST OF PARTS AND HARDWARE/ LISTE DES PIÈCES ET DU MATÉRIEL/ LISTA DE PIEZAS Y HARDWARE

NO#/ NOMBRE/ NÚMERO	DESCRIPTION/ DESCRIPTION/ DESCRIPCIÓN	QUANTITY/ QUANTITÉ/ CANTIDAD
A	FLAT WASHER/ RONDELLE PLATE/ 5/16" DIAMETER x 3/4" x 1/16" 	4 PCS
B	LOCK WASHER/ RONDELLE DE BLOCAGE/ ARANDELA DE BLOQUEO 5/16" DIAMETER x 1/2" x 1/16" 	4 PCS
C	BOLT/ BOULON/ TORNILLO 5/16" DIAMETER x 1-5/8" LENGTH 	3 PCS
D	BOLT/ BOULON/ TORNILLO 5/16" DIAMETER x 1.3/8" LENGTH 	1 PC
E	BOLT/ BOULON/ TORNILLO 1/4" DIAMETER x 3/4" LENGTH 	6 PCS
F	FLAT WASHER/ RONDELLE PLATE/ 1/4" DIAMETER x 3/4" 	6 PCS
G	LOCK WASHER/ RONDELLE DE BLOCAGE/ ARANDELA DE BLOQUEO 1/4" DIAMETER x 3/8" 	6 PCS
H	PATT METAL/ PATTE MÉTAL/ PATRÓN DE METAL 	1 PC
I	ALLEN KEY/ CLÉ ALLEN/ LLAVE INGLESA ALLEN 5/32" 	1 PC

LIST OF PARTS AND HARDWARE/ LISTE DES PIÈCES ET DU MATÉRIEL/ LISTA DE PIEZAS Y HARDWARE

NO#/ NOMBRE/ NÚMERO	DESCRIPTION/ DESCRIPTION/ DESCRIPCIÓN	QUANTITY/ QUANTITÉ/ CANTIDAD
1	TOP GLASS/ VERRE SUPÉRIEUR/ VIDRIO SUPERIOR 	1 PC
2	LEG FRAME/ CADRE DE JAMBES/ MARCO DE PIERNAS 	1 PC
3	LEG L/ JAMBE L/ PIERNA L 	1 PC
4	STRETCHER SUPPORT GLASS/ SUPPORT DE CIVIÈRE EN VERRE / SOPORTE CAMILLA VIDRIO 	1 PC

NOTE:
ASSEMBLE UNIT ON A SOFT SURFACE.
ASSEMBLEZ L'UNITÉ SUR UNE SURFACE MOLLE.
ENSAMBLE LA UNIDAD EN UNA SUPERFICIE PLANA Y SUAVE.

DO NOT TIGHTEN BOLTS UNTIL ALL PARTS AND HARDWARE OF THE UNIT ARE ASSEMBLED.
NE SERREZ PAS LES BOULONS JUSQU'À CE QUE L'UNITÉ SOIT COMPLÈTEMENT ASSEMBLÉE.
NO APRIETE LOS TORNILLOS HASTA QUE LA UNIDAD ESTE COMPLETAMENTE ENSAMBLADA.



WARNING:
ONLY USE THE HAND
TOOLS PROVIDED

ASSEMBLY INSTRUCTIONS

INSTRUCTIONS DE MONTAGE

INSTRUCCIONES DE MONTAJE

COCKTAIL TABLE

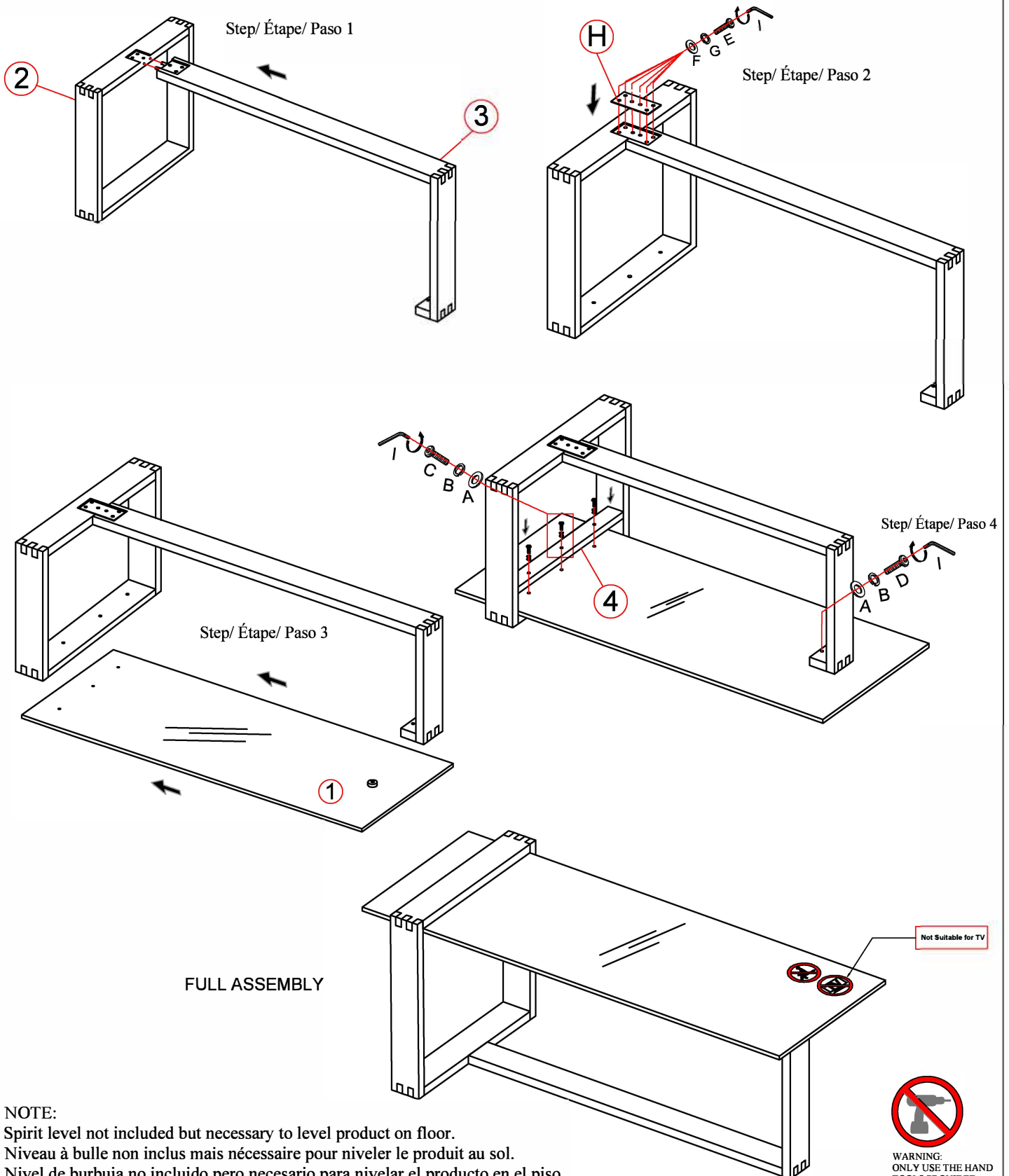

WARNING:
 ONLY USE THE HAND
 TOOLS PROVIDED

ASSEMBLY INSTRUCTIONS

INSTRUCTIONS DE MONTAGE

INSTRUCCIONES DE MONTAJE

SOFA TABLE











CAUTION: PLEASE READ ALL INSTRUCTIONS BEFORE STARTING THE ASSEMBLY OF THIS PRODUCT. THESE PIECES ARE HEAVY. IN ORDER TO PREVENT PERSONAL INJURY AND ENSURE THAT THIS PRODUCT IS NOT DAMAGED DURING THE ASSEMBLY PROCESS, IT IS STRONGLY RECOMMENDED TO ENLIST THE ASSISTANCE OF ONE OR MORE PERSONS. IN CASE OF EXCESS STAIN, WIPE THE BOTTOM OF THE UNIT BEFORE PLACING ON ANY SURFACE.

ATTENTION: VEUILLEZ LIRE TOUTES LES INSTRUCTIONS AVANT DE COMMENCER L'ASSEMBLAGE DE CE PRODUIT. LES PIECES SONT LOURDES. POUR EVITER TOUTE BLESSURE ET POUR VOUS ASSURER QUE LE PRODUIT N'EST PAS ENDOMMAGE' PENDANT L'ASSEMBLAGE, NOUS VOUS RECOMMANDONS DE FAIRE APPEL A UNE OU PLUSIEURS AUTRES PERSONNES. EN CAS DE TACHE EXCESSIVE, ESSUYEZ LE FOND DE L'UNITE' AVANT LE PLACEMENT SUR N'IMPORTE QUELLE SURFACE.





CUIDADO: FAVOR DE LEER TODAS LAS INSTRUCCIONES ANTES DE ENSAMBLAR SU PRODUCTO, ESTAS. PIEZAS SON PESADAS. PARA PREVENIR HERIDAS PERSONALES Y ASEGURAR QUE SU PRODUCTO NO SEA DANADO MIENTRAS ES ENSAMBLADO. SE RECOMIENDA LA ASISTENCIA DE UNA O MAS PERSONAS.

WARNING: PROTECTIVE GLIDE IS PLACED UNDER EACH LEG OF THE FURNITURE TO RESIST SCRATCHES ON FLOOR SURFACE. SOME FLOOR SURFACES CAN BE EXTRA SENSITIVE TO SCRATCHES AND MARKINGS, IF YOU ARE NOT SURE CONSULT WITH YOUR DEALER.
AVERTISSEMENT. LES PIEDS DES MEUBLES SONT MUNIS DE PATINS DESTINES A PROTEGER LE PLANCHER. CERTAINS REVETEMENTS DE SOL PEUVENT ETRE TRES FRAGILES. EN CAS DE DOUTE. CONSULTER LE MARCHAND.

LIST OF PARTS AND HARDWARE/ LISTE DES PIÈCES ET DU MATÉRIEL/ LISTA DE PIEZAS Y HARDWARE

NO#/ NOMBRE/ NÚMERO	DESCRIPTION/ DESCRIPTION/ DESCRIPCIÓN	QUANTITY/ QUANTITÉ/ CANTIDAD
A	FLAT WASHER/ RONDELLE PLATE/ 5/16" DIAMETER x 3/4" x 1/16" 	5 PCS
B	LOCK WASHER/ RONDELLE DE BLOCAGE/ARANDELA DE BLOQUEO 5/16" DIAMETER x 1/2"x 1/16" 	5 PCS
C	BOLT/ BOULON/ TORNILLO 5/16"DIAMETER x 1-5/8 " LENGTH 	3 PCS
D	BOLT/ BOULON/ TORNILLO 5/16"DIAMETER x 1.3/8" LENGTH 	2 PCS
E	BOLT/ BOULON/ TORNILLO 1/4"DIAMETER x 3/4 " LENGTH 	12 PCS
F	FLAT WASHER/ RONDELLE PLATE/ 1/4" DIAMETER x 3/4" 	12 PCS
G	LOCK WASHER/ RONDELLE DE BLOCAGE/ARANDELA DE BLOQUEO 1/4" DIAMETER x 3/8" 	12 PCS
H	PATT METAL/ PATTE MÉTAL/PATRÓN DE METAL 	2 PCS
I	ALLEN KEY/ CLÉ ALLEN/LLAVE INGLESA ALLEN 5/32" 	1 PC
J	TILT KIT BRACKET/ SUPPORT DE KIT D'INCLINAISON/ SOPORTE KIT INCLINACIÓN 	1 PC

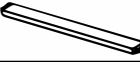
LIST OF PARTS AND HARDWARE/ LISTE DES PIÈCES ET DU MATÉRIEL/ LISTA DE PIEZAS Y HARDWARE

NO#/ NOMBRE/ NÚMERO	DESCRIPTION/ DESCRIPTION/ DESCRIPCIÓN	QUANTITY/ QUANTITÉ/ CANTIDAD
1	TOP GLASS/ VERRE SUPÉRIEUR/ VIDRIO SUPERIOR 	1 PC
2	LEFT LEG FRAME/ CADRE DE LA JAMBE GAUCHE/ MARCO DE PIERNA IZQUIERDA 	1 PC
3	RIGHT LEG FRAME/ CADRE DE LA JAMBE DROITE/ MARCO DE PIERNA DERECHA 	1 PC
4	RAIL BOTTOM/ FOND DE RAIL/ PARTE INFERIOR DEL RIEL 	1 PC
5	STRETCHER SUPPORT GLASS/ SUPPORT DE CIVIÈRE EN VERRE / SOPORTE CAMILLA VIDRIO 	1 PC

NOTE:
ASSEMBLE UNIT ON A SOFT SURFACE.
ASSEMBLEZ L'UNITÉ SUR UNE SURFACE MOLLE.
ENSAMBLE LA UNIDAD EN UNA SUPERFICIE PLANA Y SUAWE.

DO NOT TIGHTEN BOLTS UNTIL ALL PARTS AND HARDWARE OF THE UNIT ARE ASSEMBLED.
NE SERREZ PAS LES BOULONS JUSQU'À CE QUE L'UNITÉ SOIT COMPLÈTEMENT ASSEMBLÉE.
NO APRIETE LOS TORNILLOS HASTA QUE LA UNIDAD ESTE COMPLETAMENTE ENSAMBLADA.



WARNING:
ONLY USE THE HAND
TOOLS PROVIDED

ASSEMBLY INSTRUCTIONS

INSTRUCTIONS DE MONTAGE

INSTRUCCIONES DE MONTAJE

SOFA TABLE

Step/ Étape/ Paso 1

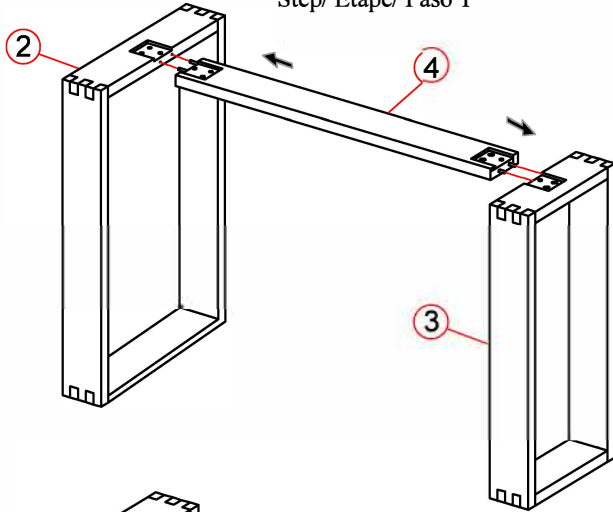

Step/ Étape/ Paso 2

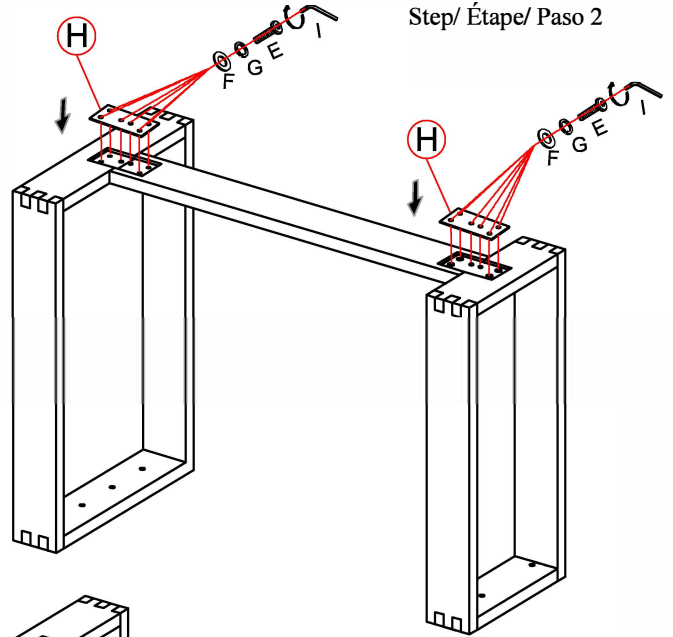

Step/ Étape/ Paso 3

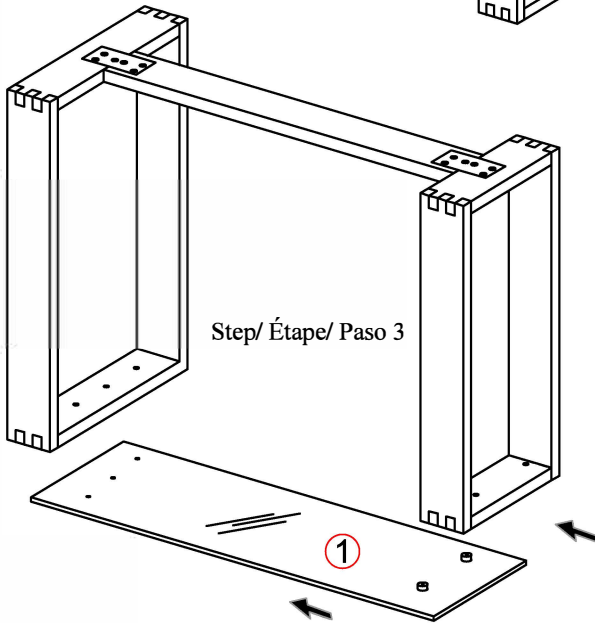

Step/ Étape/ Paso 4

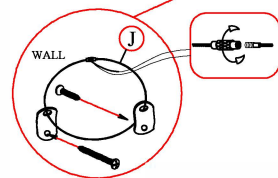
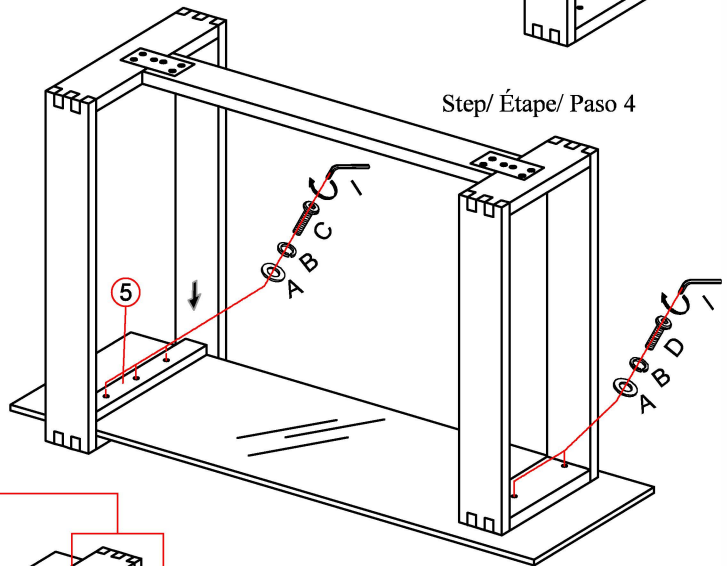

FULL ASSEMBLY

Not Suitable for TV

NOTE:
 Spirit level not included but necessary to level product on floor.
 Niveau à bulle non inclus mais nécessaire pour niveler le produit au sol.
 Nivel de burbuja no incluido pero necesario para nivelar el producto en el piso.



WARNING:
 ONLY USE THE HAND
 TOOLS PROVIDED