

1. Insert the nuts into the holes in the table legs, then place the spring washer and washers on the threaded rods of the seat base, align the table legs with the threaded rods and tighten.

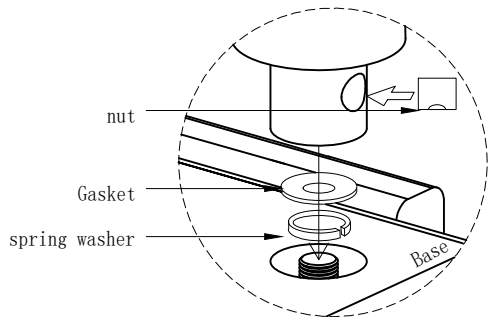

2. The installation is complete

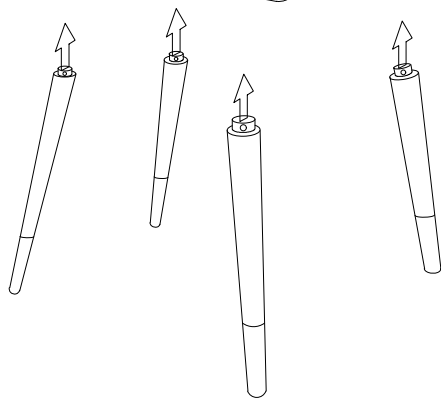

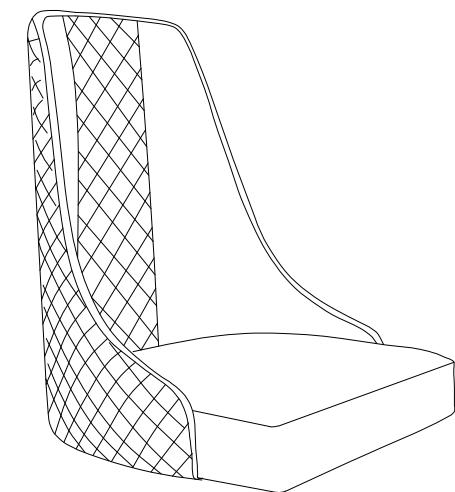
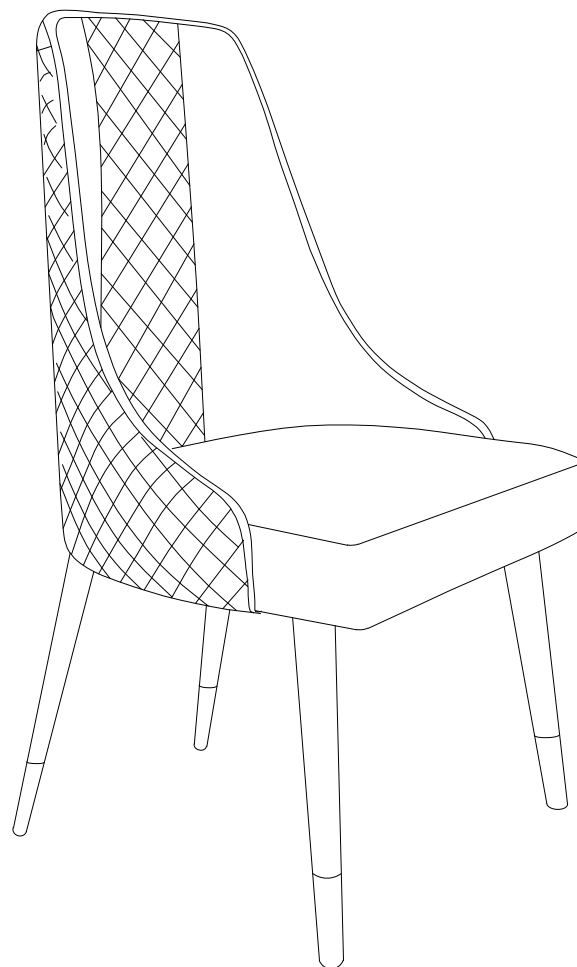

Installation instruction



Installation

The number of people needed for installation: 2

- ① Please read the manual carefully before installing this product. And strictly follow the installation process
- ② Please take good care of this manual for your next installation
- ③ Note: Before installation, screw all the screws to 1/2 of the length of the installation. After all screws are half screwed in, tighten them all together.

Parts list		On a red ribbon are furniture installation accessories		
Serial number	Shape	Name	Quantity required for installation	Spare quantity
A		nut (M8*15mm)	8	1
B		spring washer (ø20)	8	0
C		Gasket (ø8-ø30)	8	0
D				
E				
F				
G				