

Assembly Instructions

Short Tiered Shelf

450

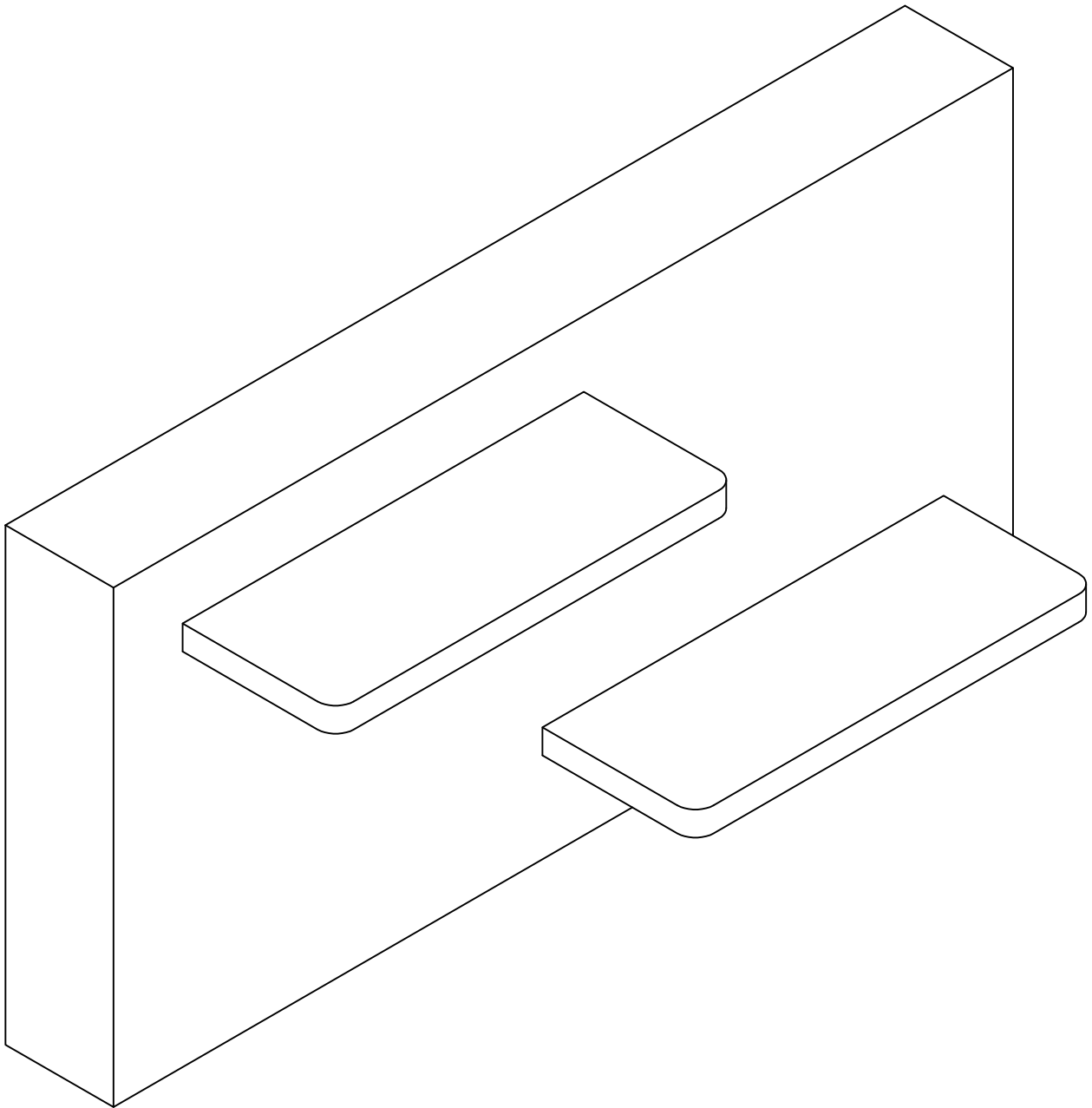

Board and Hardware Identification

Not actual size

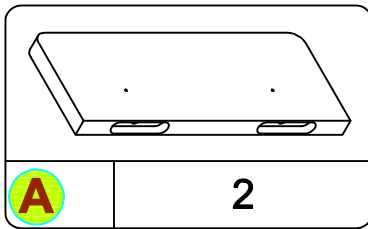

Tiered shelf

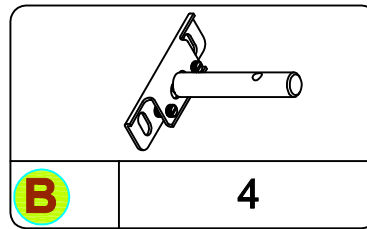

Invisible laminate support

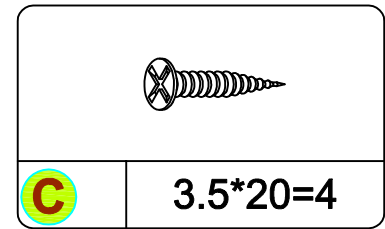

Screw

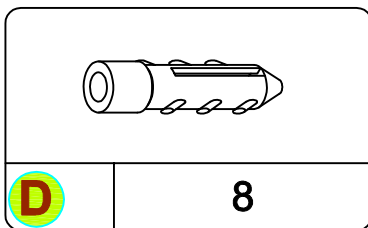

Expansion Nut

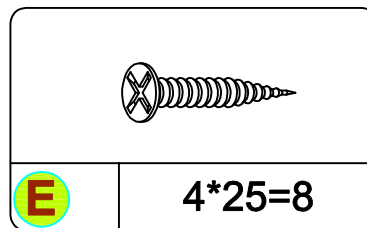

Screw

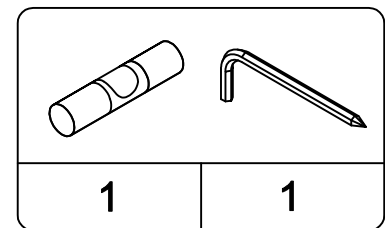

level screwdriver

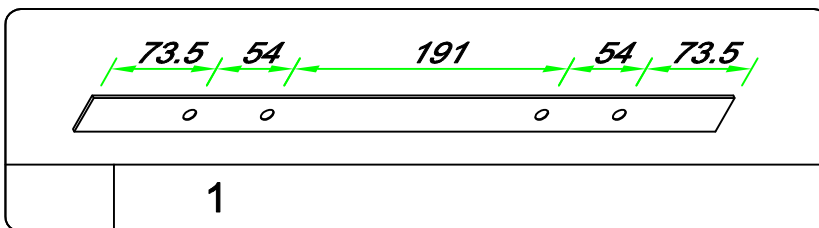

Installation template

Step 1

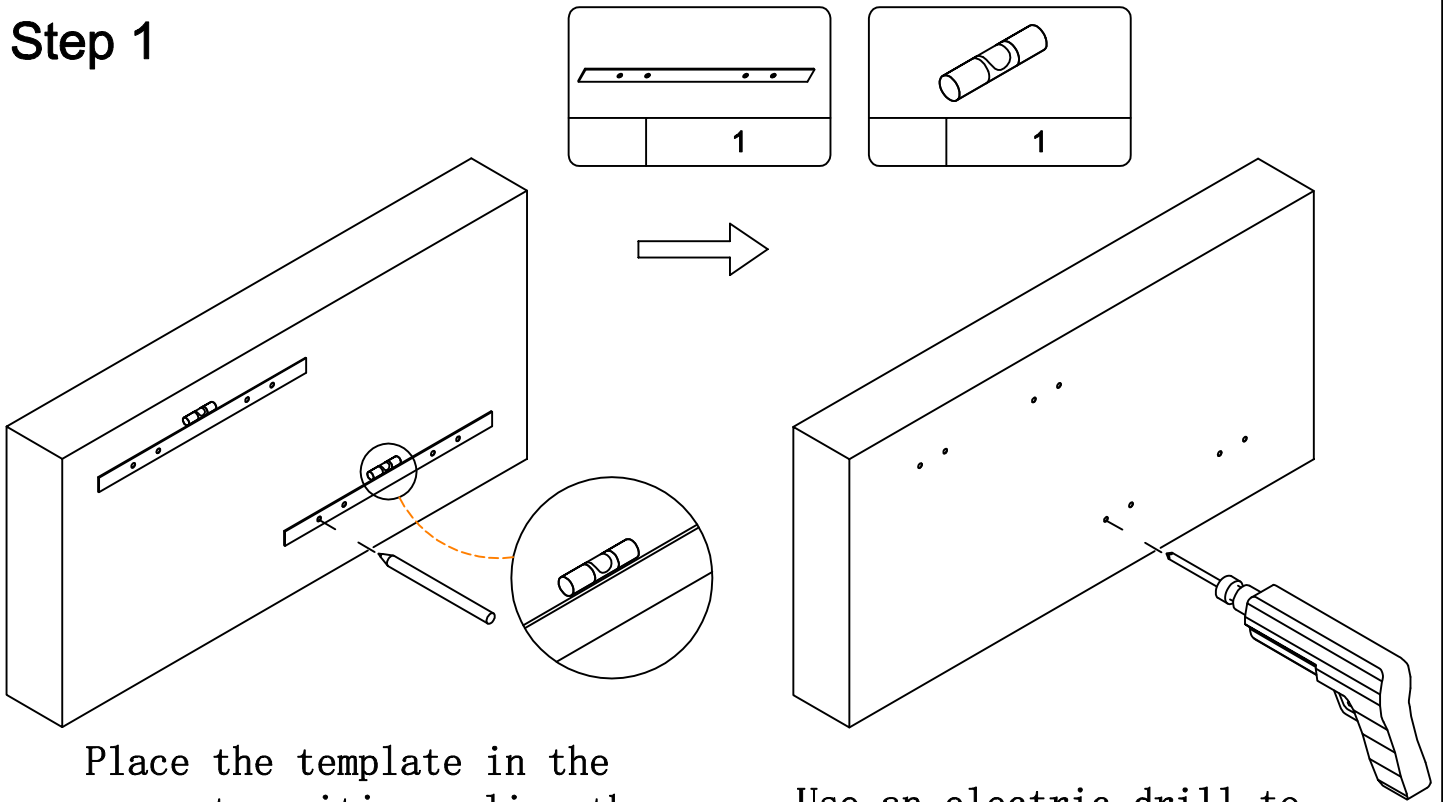

Place the template in the correct position, align the level, and draw the holes on the template

Use an electric drill to drill the drawn hole to the appropriate depth

Step 2

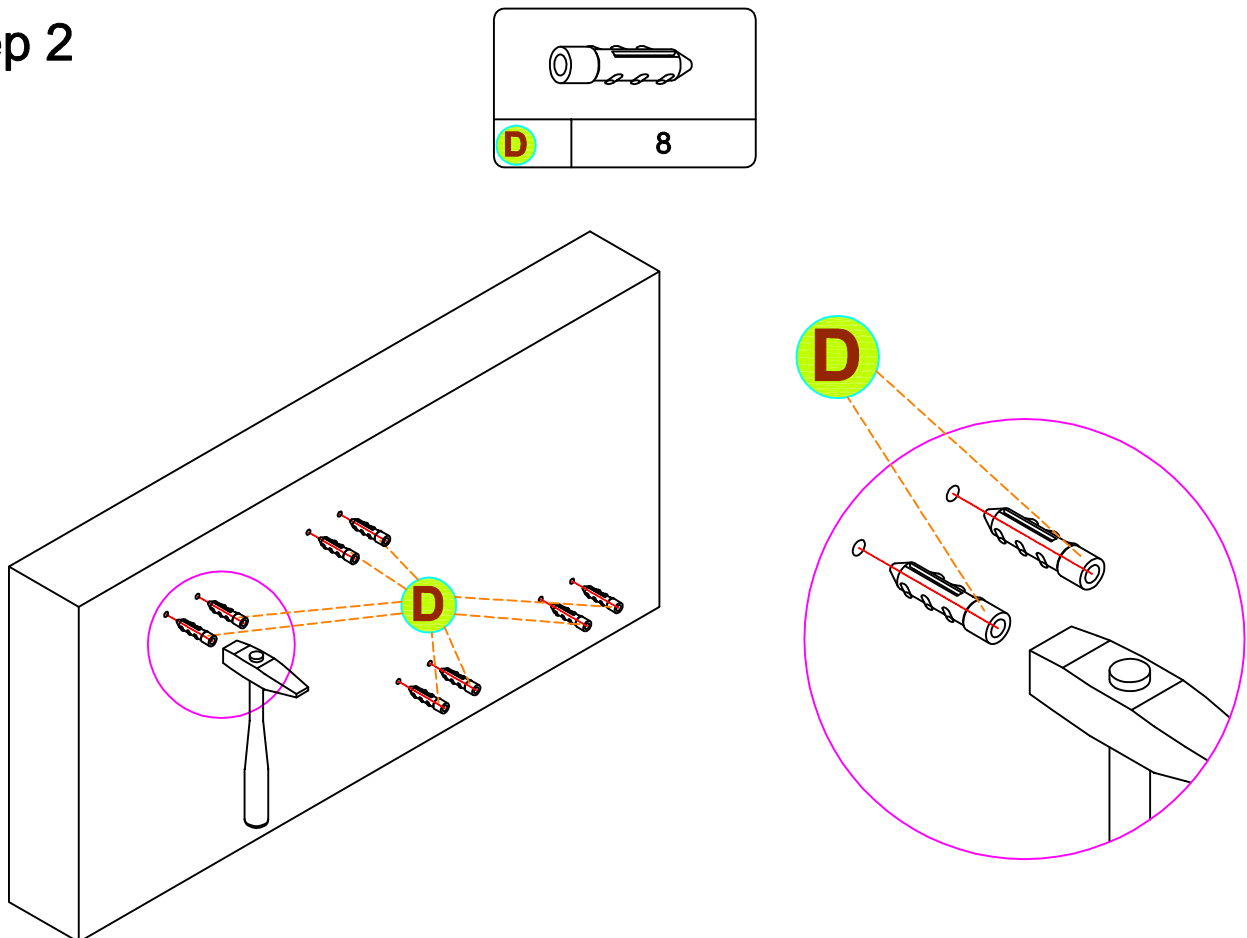

Step 3

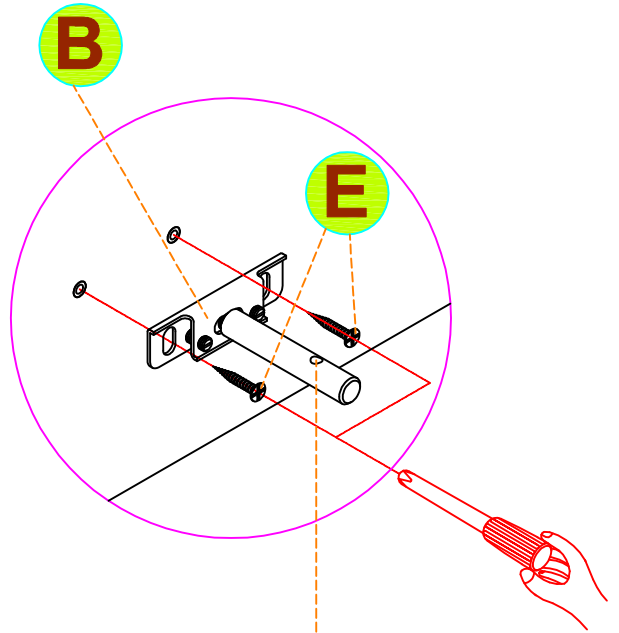
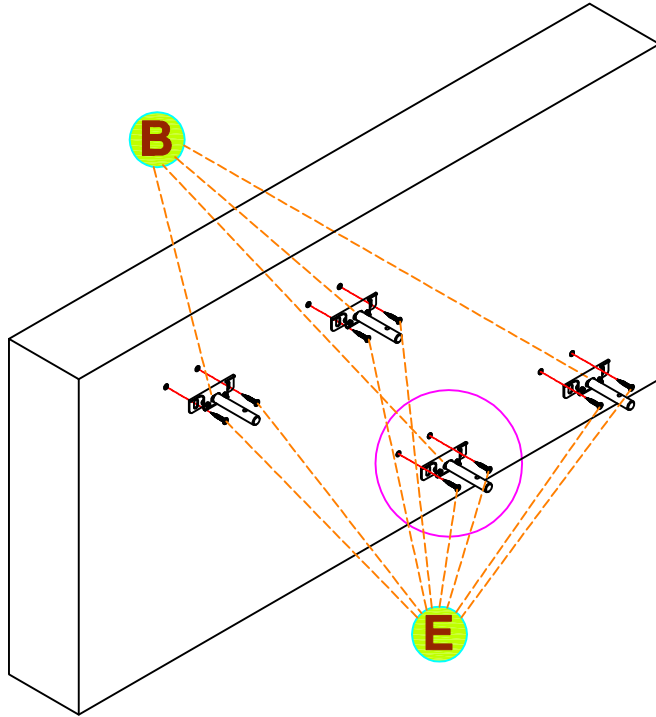
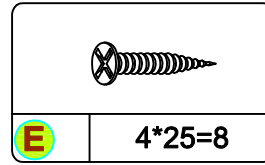
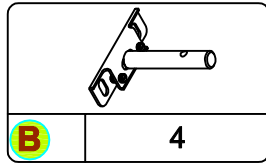

Vertical in the middle of the hole

Step 4

