







Please place all bamboo parts onto a clean, dry, and soft surface to avoid scratching during the assembly of your furniture.

Assembly Instructions

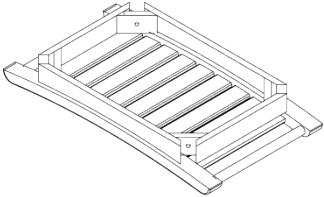
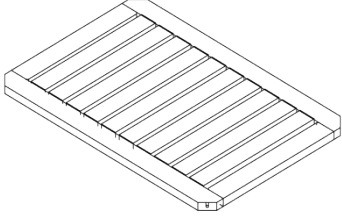
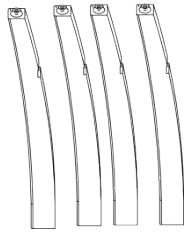

- Renewable resource – Bamboo has the Fastest Growing Cycle of any furniture raw material – 5 years sprout to harvest.
- Bamboo also has superior structural strength as well as the lowest moisture expansion/contraction displacement of any furniture raw material 50% lower than Oak or Pine
- Environmentally desirable UV activated finish – virtually 100% of the finish is utilized without spray or runoff waste and it dries instantly when exposed to UV Light without heat.

PART	DRAWING	DESCRIPTION	QTY
A			1
B			1
C			4
D			4
E			4
F			1

Step 1

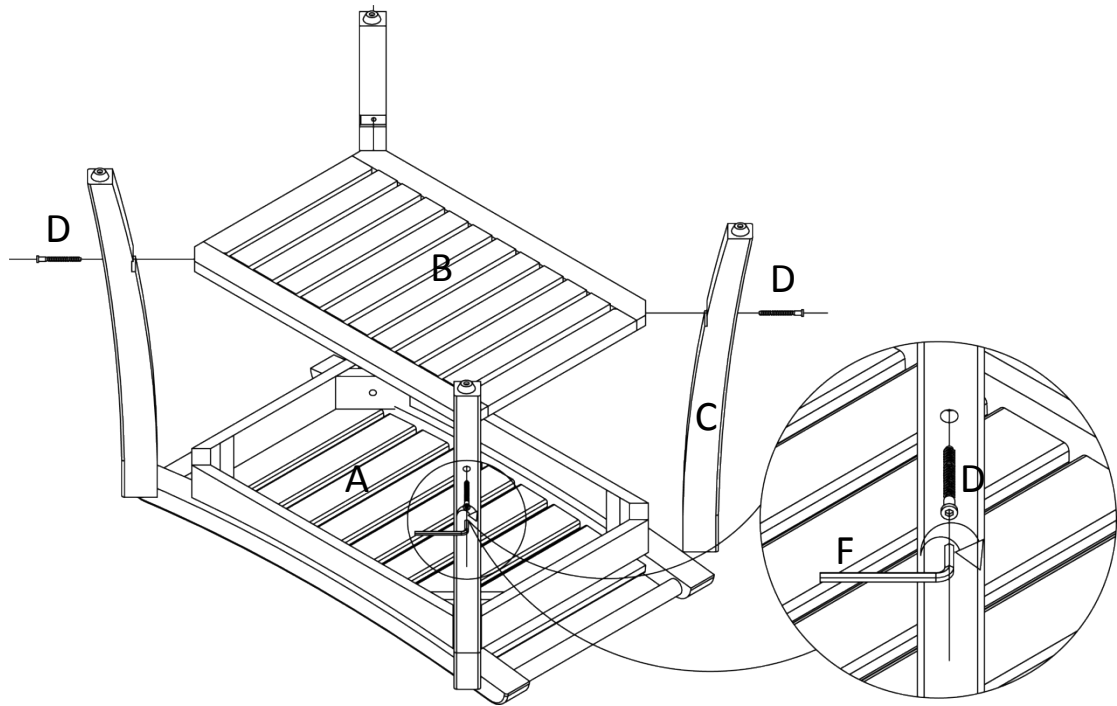

Step 2

