

COFFEE TABLE

Assembly Instructions - Please keep for future reference

CT-001

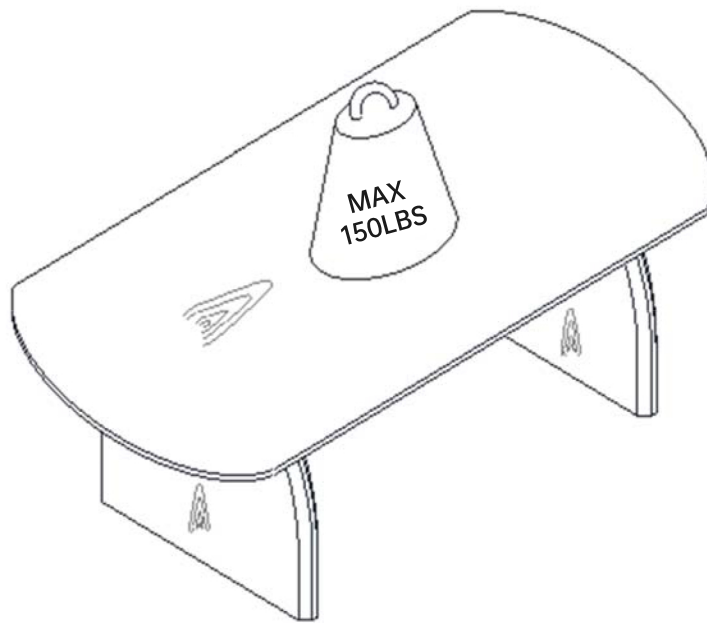

Dimensions

Width-47.24inch

Depth-23.62inch

Height-15.75inch

Important-Please read these instructions fully before starting assembly



Safety and Care Advice

Important – Please read these instructions fully before starting assembly

- Check you have all the components and tools listed on the following pages.
- Remove all fittings from the plastic bags and separate them into their groups.
- Keep children and animals away from the work area, small parts could choke if swallowed.
- Make sure you have enough space to layout the parts before starting.

- During assembly do not stand or put weight on the product, this could cause damage.
- Assemble the item as close to its final position (in the same room) as possible.
- Assemble on a soft level surface to avoid damaging the unit or your floor.
- Parts of the assembly will be easier with 2 people.



- To reduce the likelihood of damaging your product please ensure that your power drill is set on a low torque setting.

Care and maintenance

- Only clean using a damp cloth and mild detergent, do not use bleach or abrasive cleaners.
- From time to time check that there are no loose screws on this unit.
- This product should not be discarded with household waste. Take to your local authority waste disposal centre.









Handy Hints

- Assemble all parts and bolts loosely during assembly, only once the product is complete should you fully tighten the bolts
- Regularly check and ensure that all bolts and fittings are tightened properly.

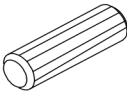
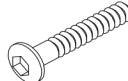
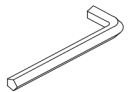
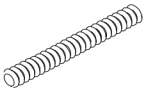
Components - Fittings

Please check you have all the panels listed below

Note: The quantities below are the correct amount to complete the assembly. In some cases more fittings may be supplied than are required.

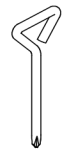
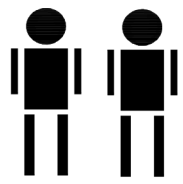
<p>A</p>  <p>35MM x2+1</p>	<p>B</p>  <p>∅14.5 x2+1</p>	<p>C</p>  <p>∅8*30 x6+1</p>	<p>D</p>  <p>M6*60 x3</p>	<p>E</p>  <p>M4 x1</p>
<p>F</p>  <p>M8*70 x4</p>	<p>G</p>  <p>M8 x4</p>	<p>H</p>  <p>M8 x4</p>	<p>I</p>  <p>x1</p>	<p>J</p>  <p>∅50 x4</p>
<p>K</p>  <p>∅22 x2</p>	<p>L</p>  <p>x1</p>	 <p>Person x2</p>		

Step 1

Connect the male camlock as directed in the assembly instructions using a screwdriver.

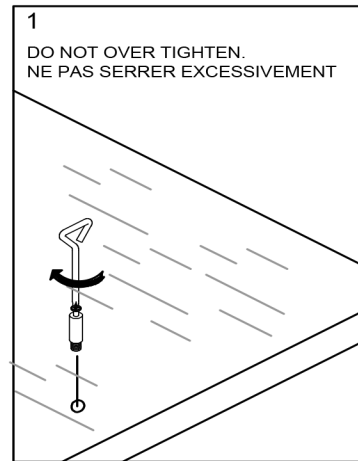

Step 2

Push the male camlock into the entry hole.

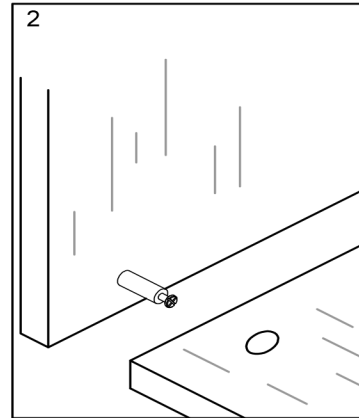

Step 3

Insert the female camlock as shown in the instruction.

Note: ensure that the arrow on the top of the camlock points towards the entry hole for the male camlock.

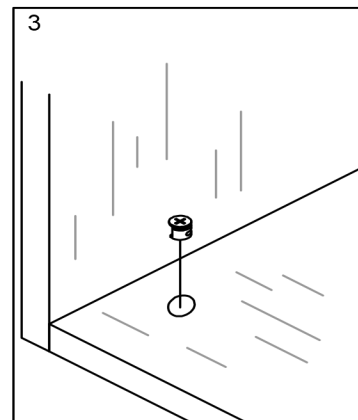

Step 4

Turn the female camlock clockwise with a screwdriver.

You should feel a click when the camlock is locked in place.

The joint is now secure.

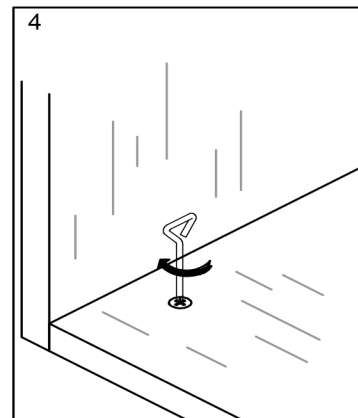

Using Camlocks 4 in 1

Step 1

Push the male camlock into the entry hole.

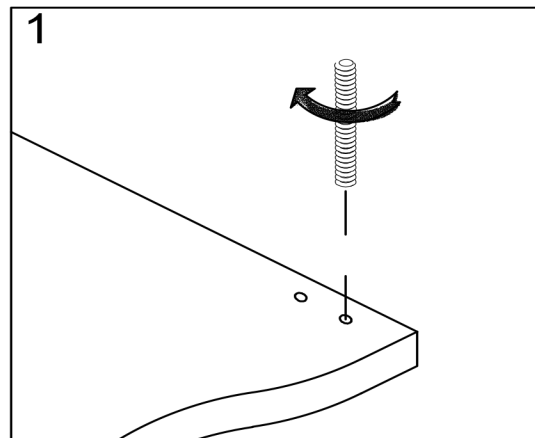

Step 2

Push the male camlock into the entry hole.

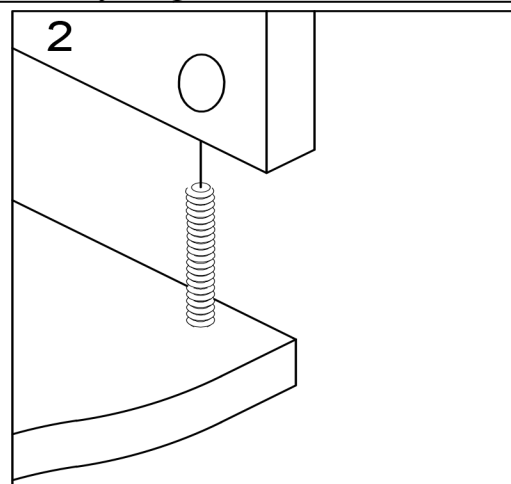

Step 3

Insert the female camlock (half-moon cam and screw nut) to ensure the female camlock hole points towards the screw pole of the male camlock.

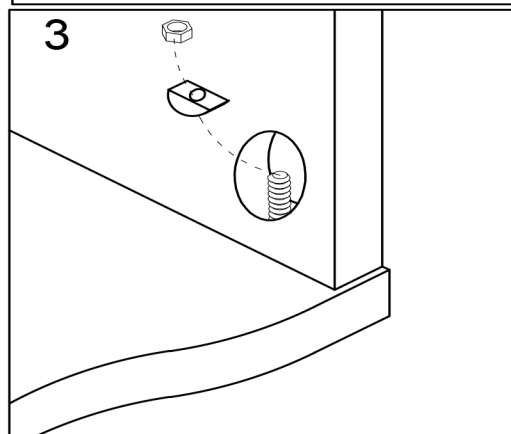

Step 4

Turn the female camlock clockwise with a wrench till the camlock is locked tightly.

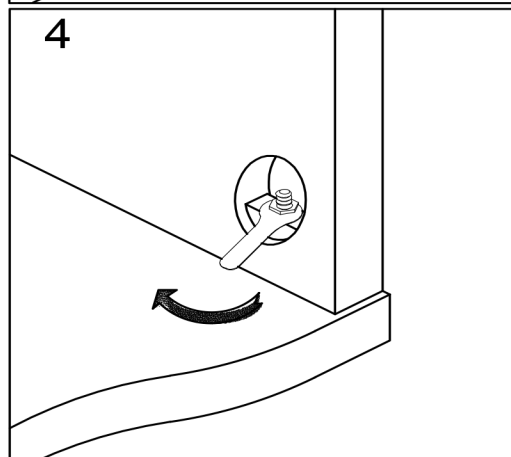

Assembly Instructions

① *1

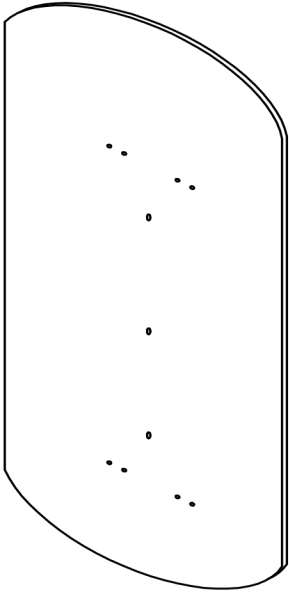

1200*600*25mm

② *2

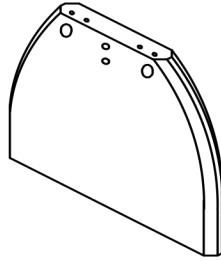

368*450*40mm

③ *1

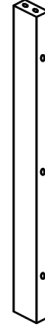





660*50*25mm

Assembly Instructions

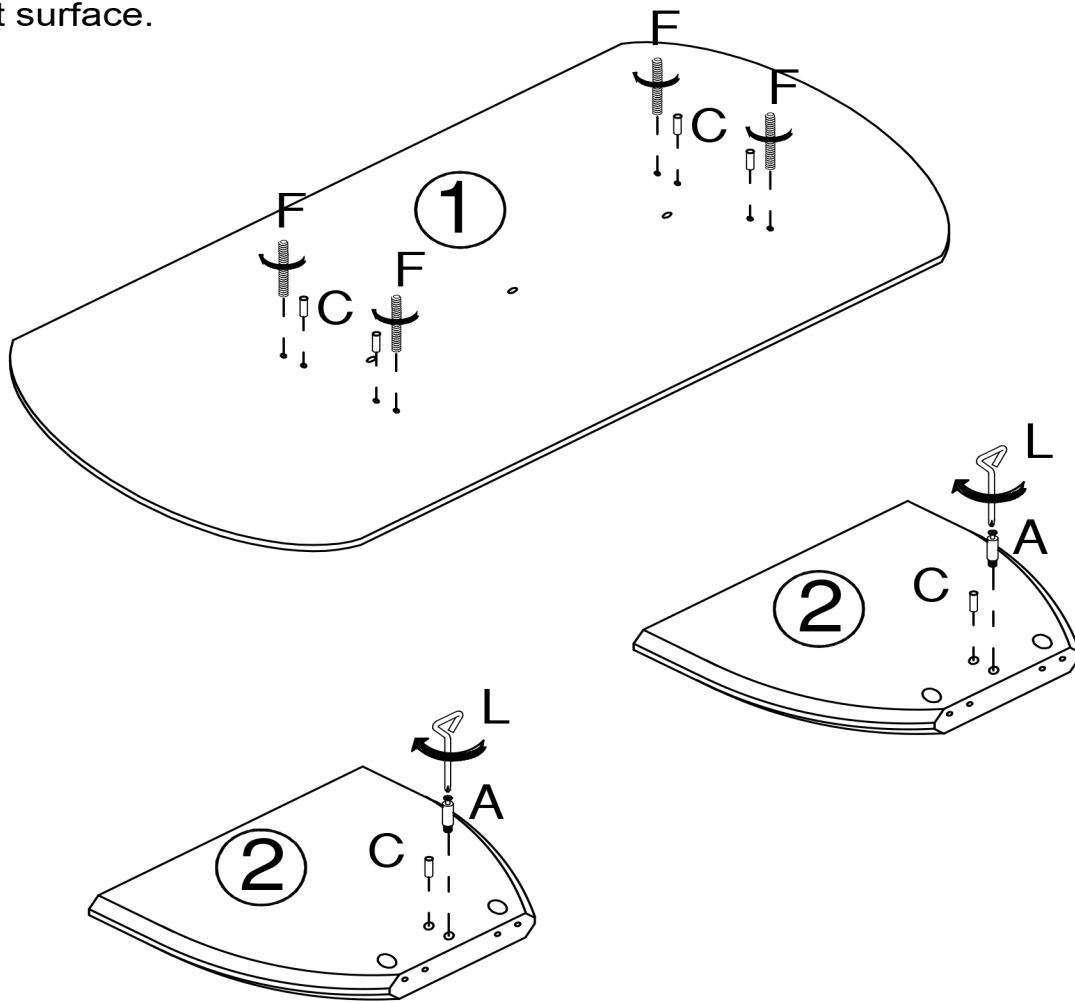
Step 1

WARNING: Before assembling the furniture, please thoroughly inspect the work area and remove any small debris to prevent scratches on the product surface.

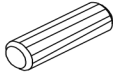



<p>A</p>  <p>35MM x2</p>	<p>C</p>  <p>∅8*30 x6</p>	<p>F</p>  <p>M8*70 x4</p>	<p>L</p>  <p>x1</p>	 <p>Person x2</p>
---	--	--	---	--

Assembly Instructions

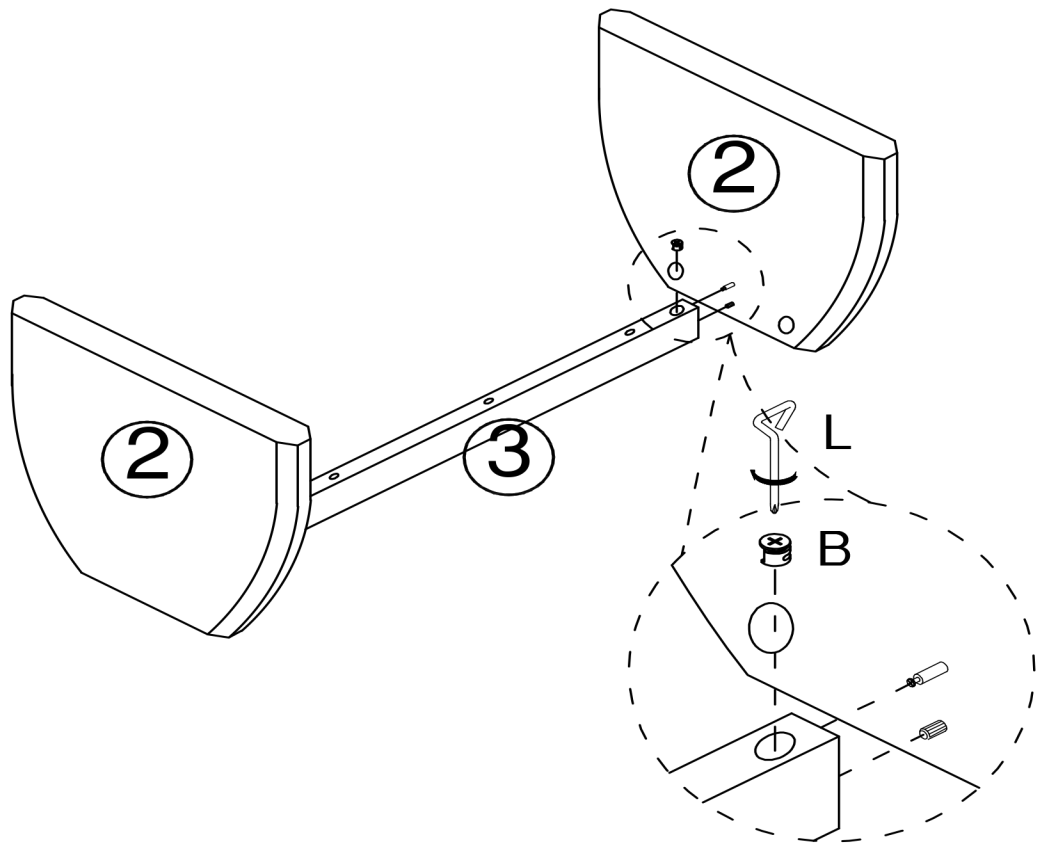
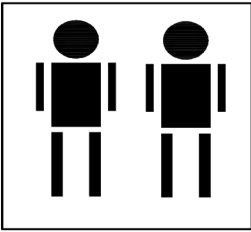
Step 2





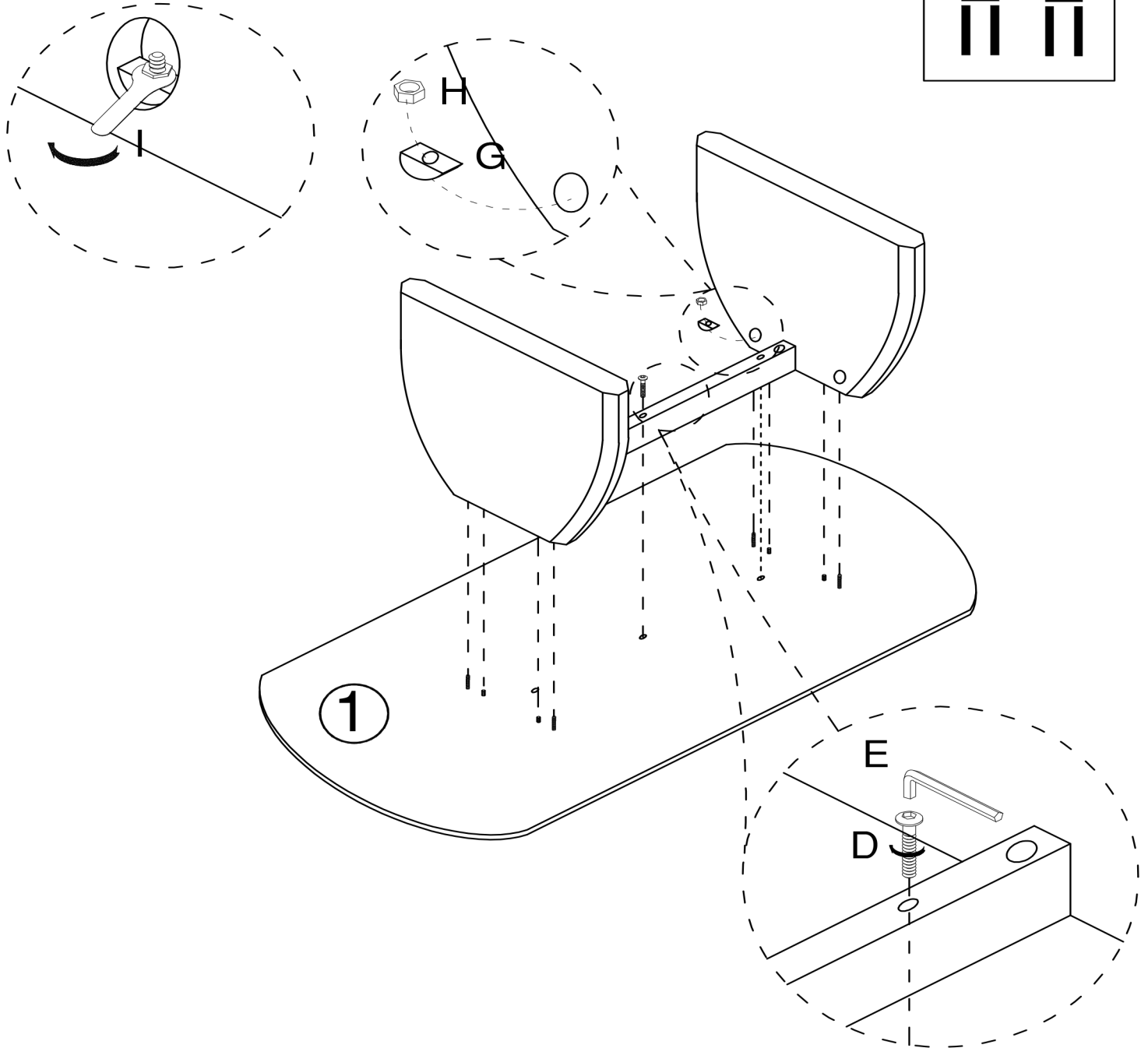
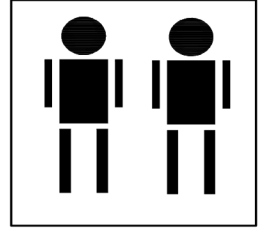

B  ø14.5 x2	L  x1	 Person x2
--	--	--

Assembly Instructions

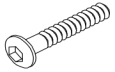
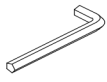
Step 3





<p>D</p>  <p>M6*60 x3</p>	<p>E</p>  <p>M4 x1</p>	<p>G</p>  <p>M8 x4</p>	<p>H</p>  <p>M8 x4</p>	<p>I</p>  <p>x1</p>	 <p>Person x2</p>
---	---	---	---	--	--

Assembly Instructions

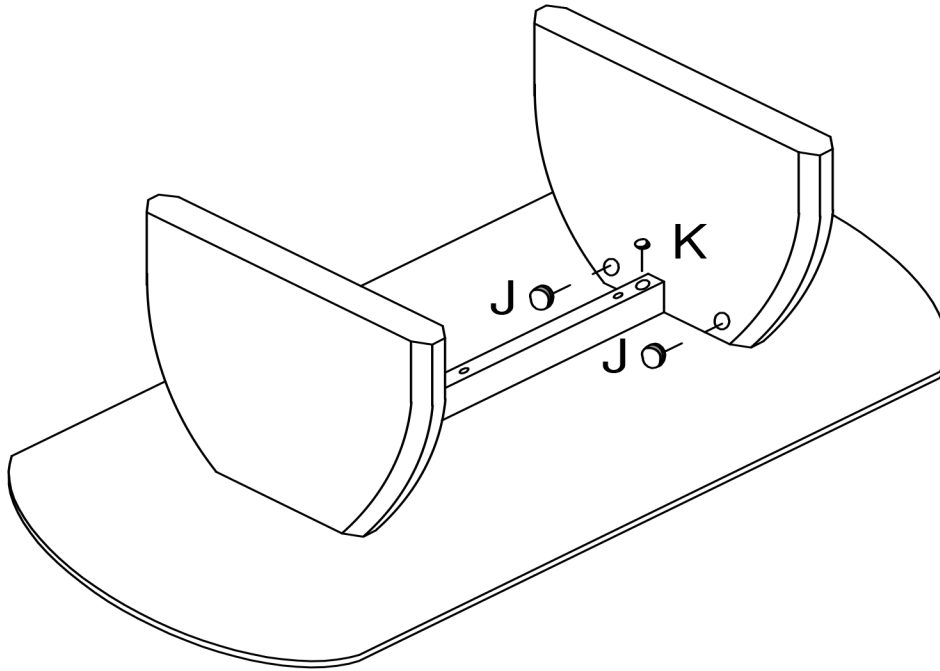
Step 4

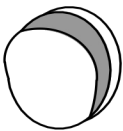

<p>J</p>  <p>ø50 x4</p>	<p>K</p>  <p>ø22 x2</p>	 <p>Person x2</p>
---	---	---

Assembly Instructions

Step 5

