





# ASSEMBLY INSTRUCTIONS & PARTS IDENTIFICATION

**Thank you for purchasing this quality product. Be sure to check all packing material carefully for small parts that may have come loose inside the carton during shipment**



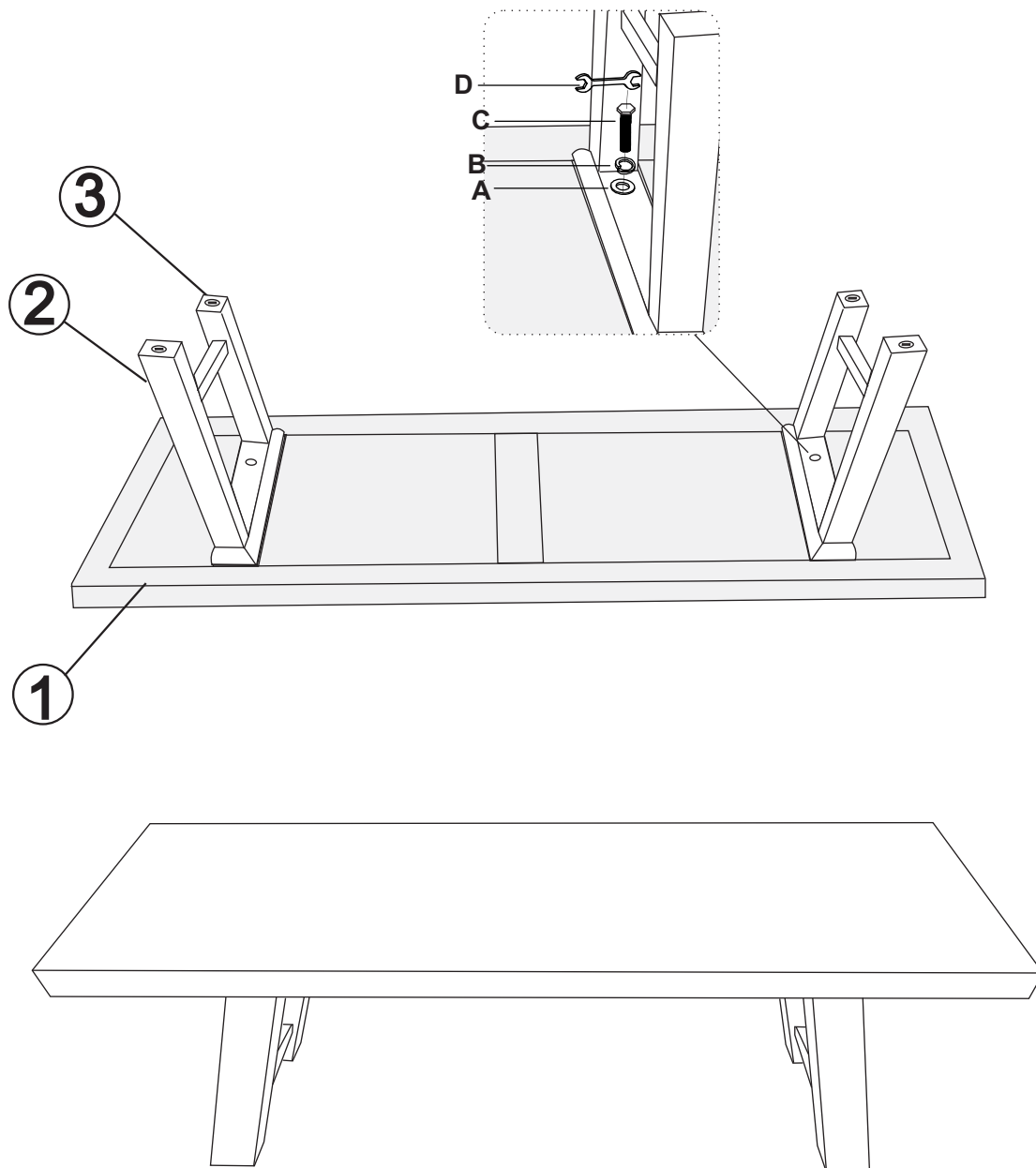

Parts key			
No	Code	Qty	Description
1		1 Pc	Bench Top
2	2301-BN60KDP53	2 Pcs	Leg Assembly
3	2301P01F	4 Pcs	Floor Glide

Hardware Kit (2301-BN60KDP46)			
No		Description	Qty
A		Flat washer M8x18	4 pcs
B		Lock washer M8	4 pcs
C		Bolt M8 x 45	4 pcs
D		Wrench	1 pc



**Thank you for purchasing this quality product. Be sure to check all packing material carefully for small parts that may have come loose inside the carton during shipment**

Parts key			
No	Code	Qty	Description
1		1 Pc	Bench Top
2	2301-BN60KDP53	2 Pcs	Leg Assembly
3	2301P01F	4 Pcs	Floor Slide

Hardware Kit (2301-BN60KDP46)			
No		Description	Qty
A		Flat washer M8x18	4 pcs
B		Lock washer M8	4 pcs
C		Bolt M8 x 45	4 pcs
D		Wrench	1 pc

