

PRODUCT INSTALLATION GUIDE

The instruction can be used for different sizes of handrail.

TOOLS YOU MAY NEED

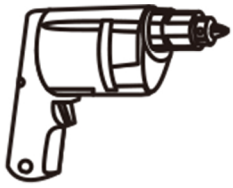

Drill



Phillips Screwdriver



Pencil









Tape Measure

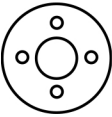
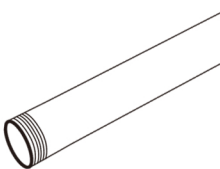
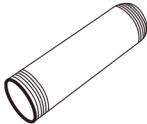

Hammer

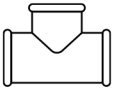
BEFORE INSTALLATION

Check to make sure you have the following parts indicated below.

									
	Flange Plate	Long Pipe	Short Pipe	Elbow	T-Connector	Screw & Anchor	Wrench	Screw-driver bit	Drill bit
2 ft Handrail	2	1	2	2	/	8	1	1	1
3.3 ft Handrail	2	1	2	2	/	8	1	1	1
5 ft Handrail	3	2	3	2	1	12	1	1	1
6.6 ft Handrail	3	2	3	2	1	12	1	1	1
8 ft Handrail	3	2	3	2	1	12	1	1	1
10 ft Handrail	4	3	4	2	2	16	1	1	1
12 ft Handrail	4	3	4	2	2	16	1	1	1
14 ft Handrail	5	4	5	2	3	20	1	1	1

Assemble the Handrail

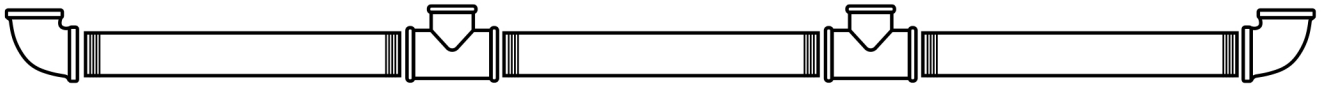

- 1** Use long pipes, T-connector(s) and elbows to assemble the handrail.

NOTE: DO NOT tighten the T-connectors and elbows with the pipe to make sure they directed in same direction.

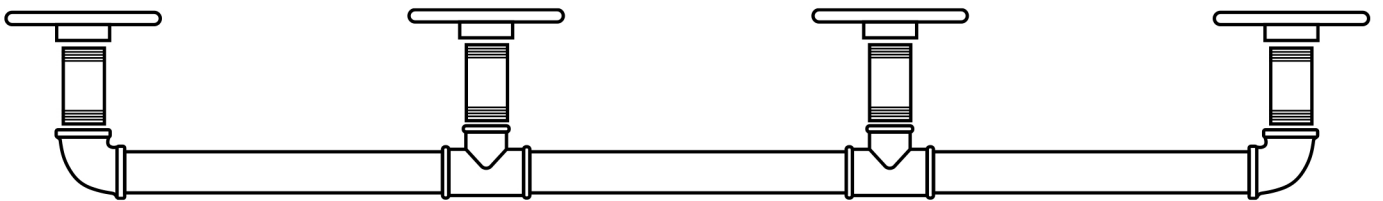

- 2** Assemble the short pipes and flange plates on the handrail.

Install the Handrail

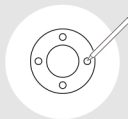
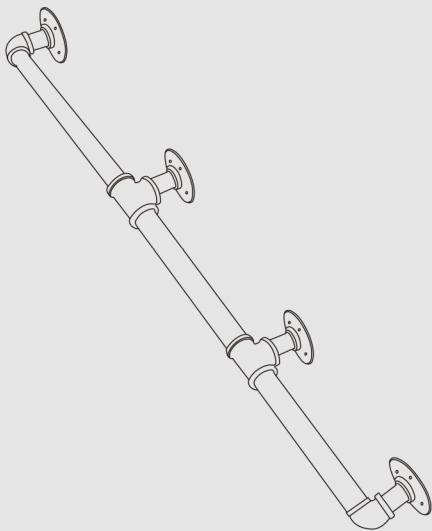

1. Put the handrail on the wall and mark the screw holes with a pencil.

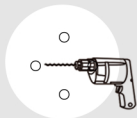

2. Drill 1/4" pilot holes a minimum of 1-1/2" deep at the marked location.

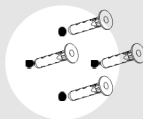

3. Insert drywall anchors with a hammer.

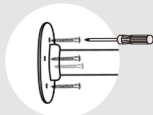

4. Attach the handrail and drive the tapping screws to fasten the product on the wall.

Thanks so much for choosing us !!

Our mission is to provide the best products to improve your house and life! We also strive to provide the best customer service and our purpose is to have 100% customer satisfaction.

If you have any concerns, please email us. We will get back to you in 24 hours.