

ASSEMBLY INSTRUCTIONS

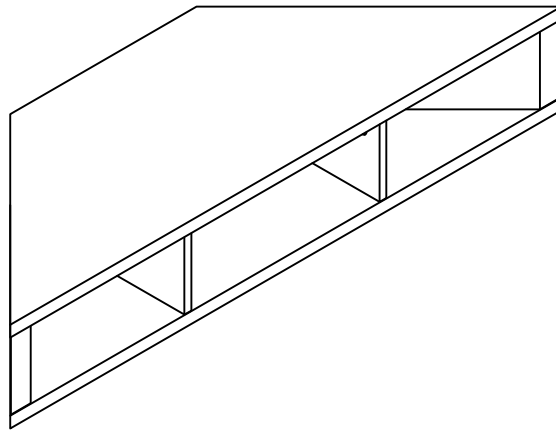



ASSEMBLY RATING

The Assembly Rating is a 5-point system that shows the degree of effort needed in assembling a specific product (with 1 being easy and 5 being difficult). For most products, two persons are recommended.

EASY  DIFFICULT

Tools Required for Assembly:

Phillips Screwdriver 
(Not Included)

Phillips Screwdriver
1 1/2" L 
(Not Included)

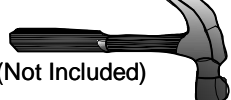
Hammer 
(Not Included)

Drill 
(Not Included)



2 PERSONS RECOMMENDED

Thank you for your purchase!

We hope you will enjoy your new product for many years to come. Our commitment to providing quality products does not simply end when a purchase is made. We stand behind our products and will provide any support needed in order for you to fully enjoy your purchase. Your satisfaction is the greatest recognition we could have.

ASSEMBLY & CARE ADVICE

FOR YOUR FURNITURE TO LAST, CORRECT ASSEMBLY AND PROPER MAINTENANCE ARE NECESSARY PLEASE FOLLOW THE INFORMATION PROVIDED BELOW TO FULLY ENJOY YOUR FURNITURE.

BASIC ASSEMBLY TECHNIQUES

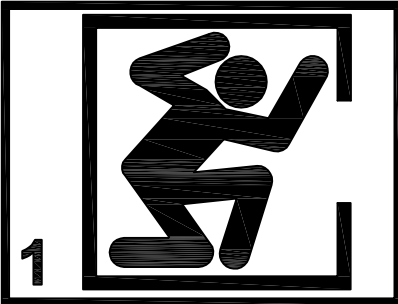

It is highly recommended that the assembly should be done near the area of its intended location. Make sure you have enough space to move around during the assembly.

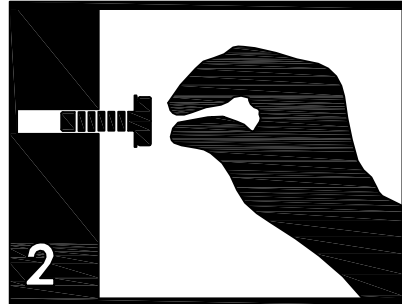

Position each part correctly and insert screws or bolts into their respective holes by hand tighten or using the proper hand tool. Only tighten when step is completed or when instructed to do so.



Use cardboard or carpet area when assembling furniture to prevent scratches. Make sure the furniture rests on a flat and level surface with each leg evenly touching the floor.

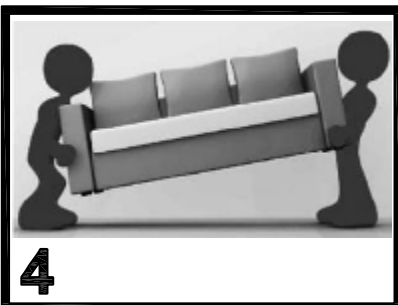

ALWAYS have at least two people to help with transporting and assembling the product to avoid any potential injury and/or damage.

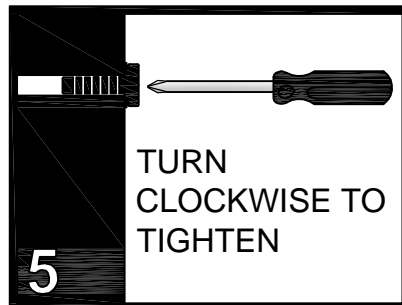

Make sure all parts are properly aligned, then use the appropriate hand tool to completely tighten the bolts or screws. Do not use power tools and do not overtighten.

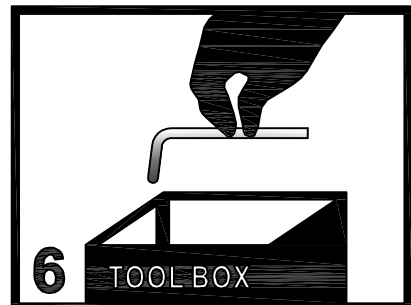

Save the instructions and store any supplied tool for later maintenance. After two weeks, check and tighten any loose hardware and repeat again every six months thereafter.

IT IS THE USER'S RESPONSIBILITY TO MAINTAIN THE FURNITURE. THE HARDWARE MAY LOOSEN OVER TIME AND MAY CAUSE THE FURNITURE TO BE WOBBLY AND UNABLE TO SUPPORT ITS INTENDED WEIGHT CAPACITY. THIS MAY LEAD TO COLLAPSE AND MAY CAUSE SERIOUS INJURY.



FAILURE TO FOLLOW THE GUIDELINES ABOVE MAY RESULT IN INJURY AND/OR PROPERTY DAMAGE.

PRE-ASSEMBLY INTRODUCTION

Unless you are particularly adept at assembling flat-pack/knock-down furniture, we understand building ready-to-assemble furniture can be a frustrating experience for some. To help avoid confusion and to make the assembly process quicker and smoother, we have provided some helpful tips. Before you begin the assembly, please read the following :

1. Due to the size and/or weight on most of the ready-to-assemble furniture, it is highly recommended that the assembly should be done near the area of its intended location. Make sure you have enough space to move around during the assembly. ALWAYS have at least two people to help with transporting and assembling of the product to avoid any potential injury and/or damage.
2. To protect from damage, assemble the item on a clean, protective surface, such as on a carpet or cardboard.
3. Make sure you have taken all the parts and hardware out of their packaging. Do not throw away packaging material until assembly is completed.
4. Make sure all parts and hardware are accounted for by comparing the actual parts and hardware to the list provided in the assembly instructions. Also check for any irregularity such as crack, flaw or improperly drilled hole. If there is any problem or missing piece, please contact the manufacturer or the supplier. Please have the model number, part number and a brief description of the problem ready will help expedite the replacement process.
5. Read the entire instruction manual and view the diagrams first before assembling. Arrange your parts in order of use and group the identical hardware together to make it easier to grab each piece as you begin to assemble.
6. During the assembly process, make sure parts are properly aligned before tightening with the tool provided or required for the assembly. Do not use power tools and do not over tighten.
7. When applying glue to the wood dowels to bond the parts together, please be ABSOLUTELY certain that the parts are correct and lined up with each other (refer to diagrams and take notice of the various pre-drilled hole locations). When in doubt, assemble the parts together first and if the parts fit right, then apply glue to the wood dowels.



CAMLOCK FASTENER ASSEMBLY INSTRUCTIONS

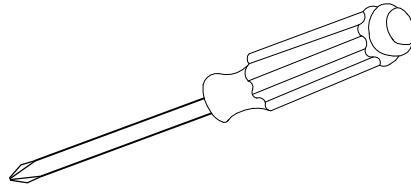
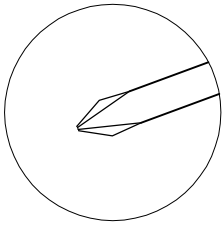

Note: Every cam lock bolt must have a cam lock connector in order to fasten the parts together.

- (1) Secure the threaded end of the cam bolt by using a screwdriver.

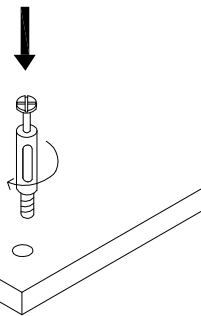

Turn right (clockwise) to tighten.

Align the cam connector with its side opening (or arrow) pointing to the small drilled hole.

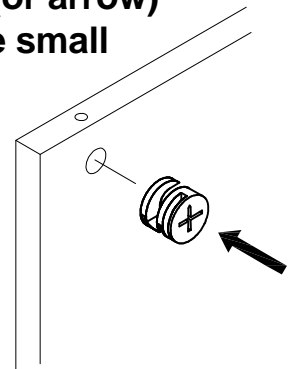

- (2) Insert the cam lock bolt into the pre-drilled hole above the cam connector.

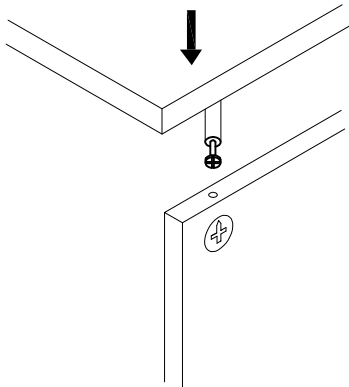

- (3) Two parts should fit snugly against each other.

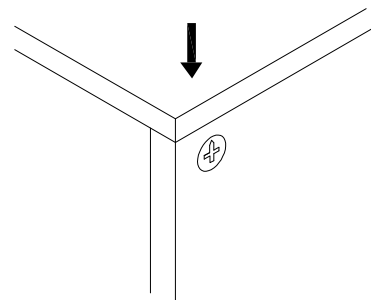

- (4) Turn right (clockwise) to tighten.

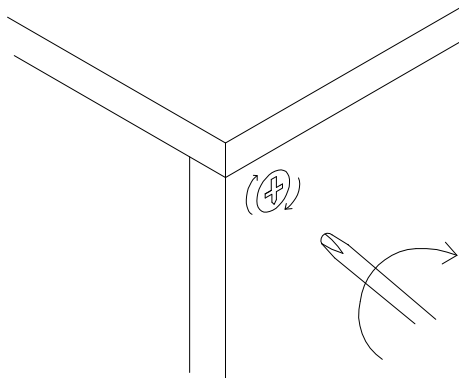

Turn the cam connector with a screwdriver until it will not turn any more with light to moderate force.



PARTS LIST

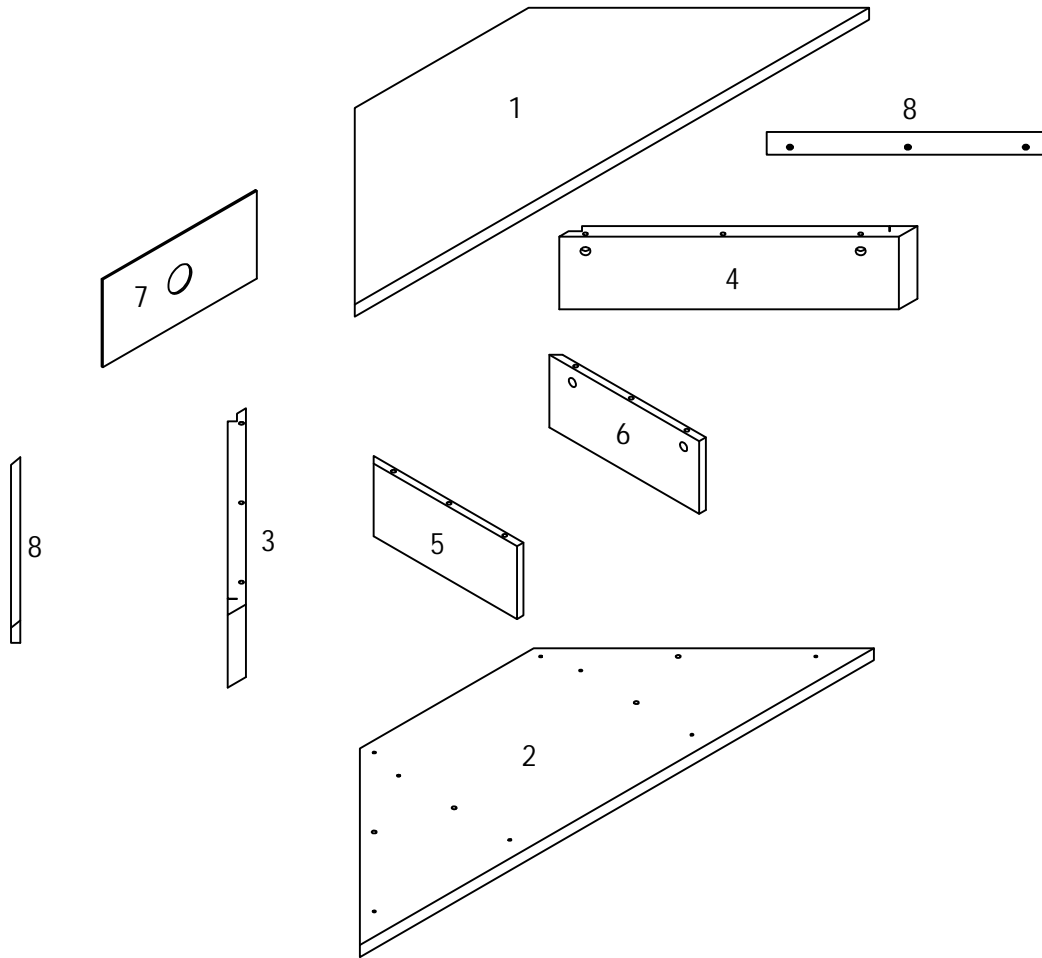







(1)	1pc	(6)	1pc
(2)	1pc	(7)	1pc
(3)	1pc	(8)	2pcs
(4)	1pc		
(5)	1pc		

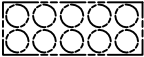

Before you begin, please read "Assembly and Care Advice", "Pre-Assembly Introduction" and "Cam Lock Fastener Assembly Instructions".

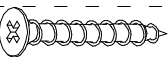
HARDWARE LIST

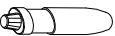
A		L29	8pcs
B		φ15	8pcs
C		φ8x25	8pcs
D		φ22	8pcs
E		φ4x45	8pcs
F			10pcs
G		φ5x50	6pcs
H		φ 8 x 40	6pcs
I		Glue: For securing please apply to wood dowel first before inserting into panel	1pc



Due to the size and/or weight of this product, it is highly recommended that the assembly should be done near the area of its intended location. Make sure you have enough space to move around during the assembly. ALWAYS have at least two people to help with transporting and assembling the product to avoid any potential injury and/or damage

ASSEMBLY INSTRUCTIONS

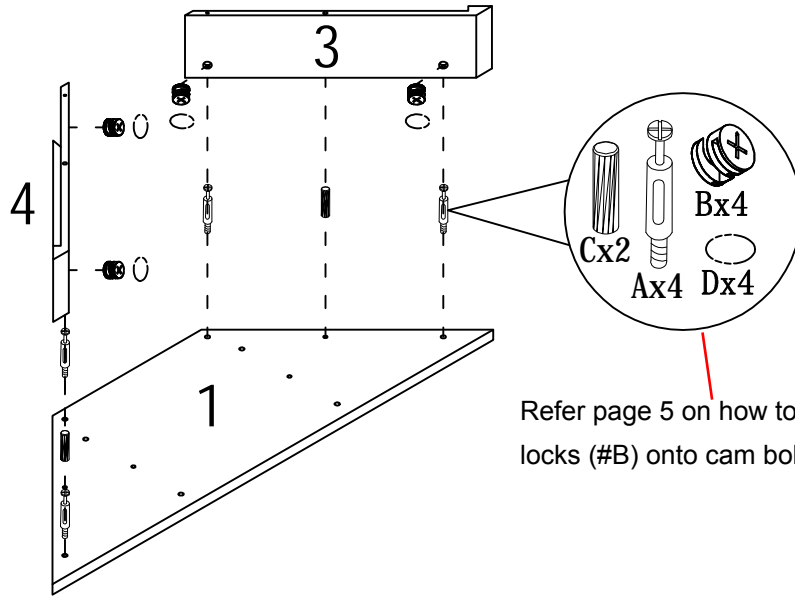

Refer page 5 on how to secure cam locks (#B) onto cam bolts (#A).

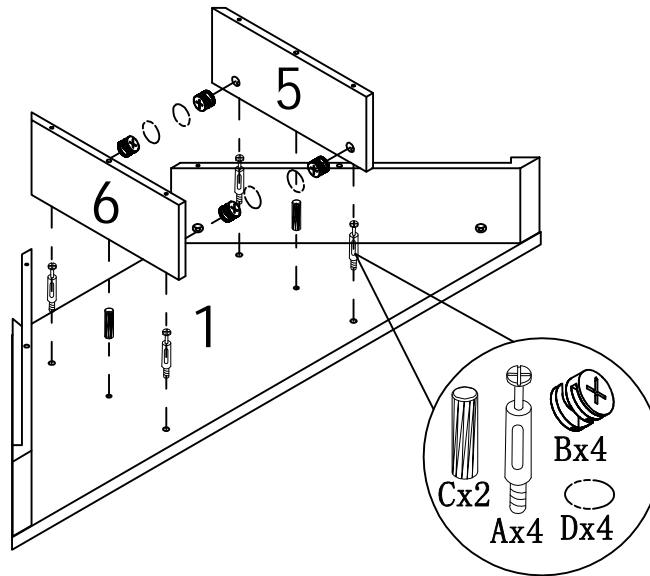

ASSEMBLY INSTRUCTIONS

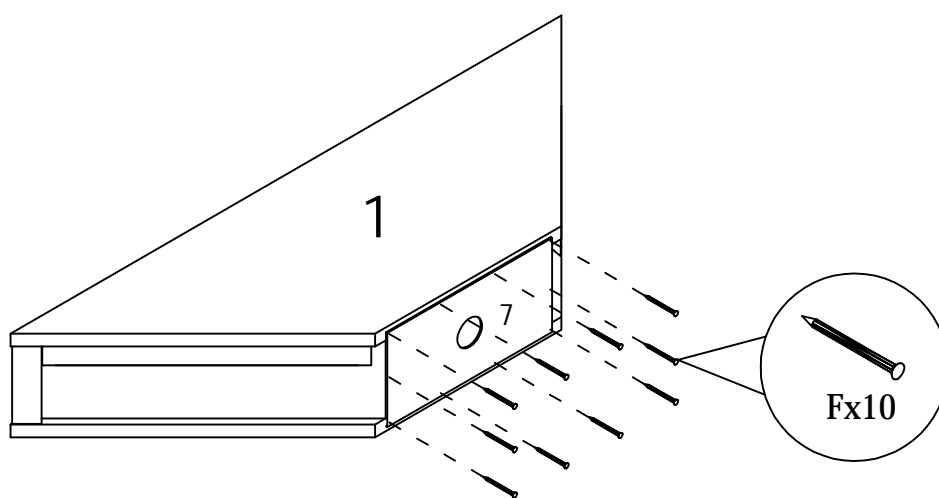
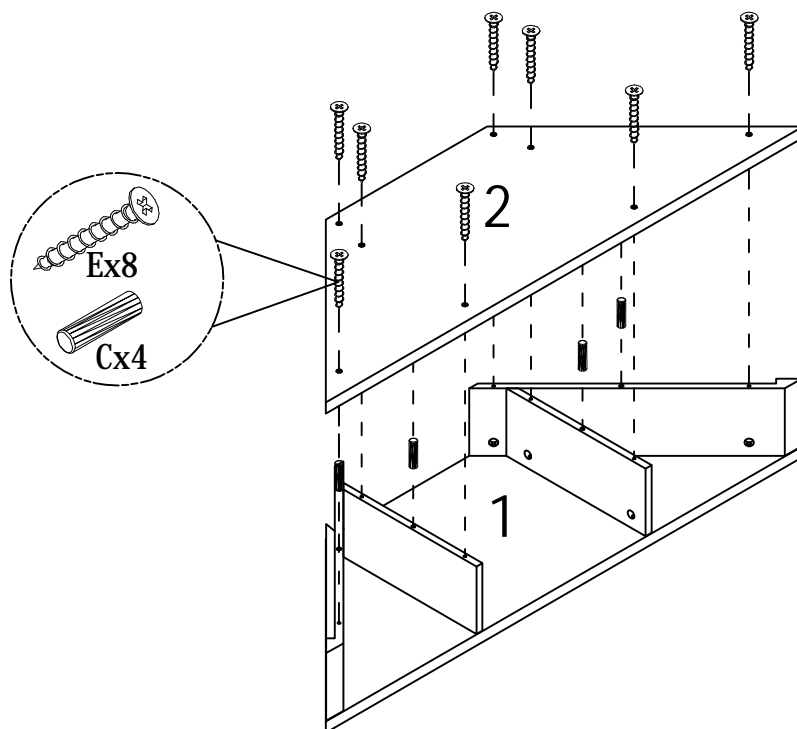

ASSEMBLY INSTRUCTIONS

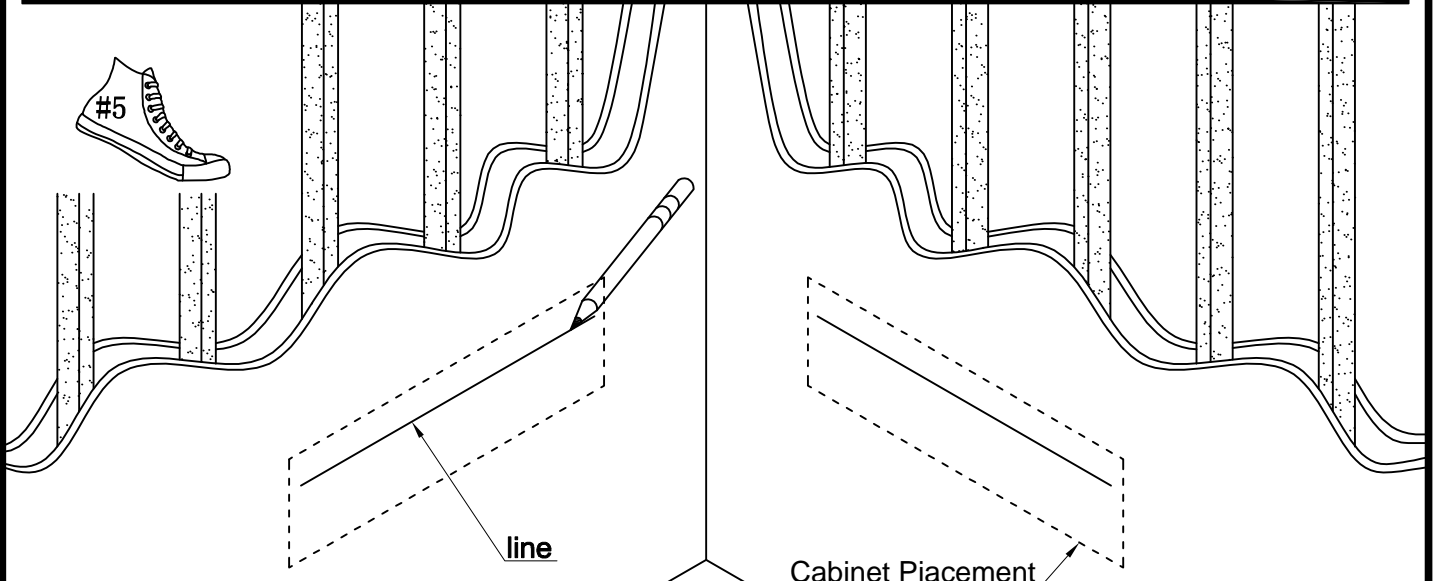

line

Cabinet Placement

Make sure the line and spacing is equivalent to the line and spacing of the product to ensure proper fit.

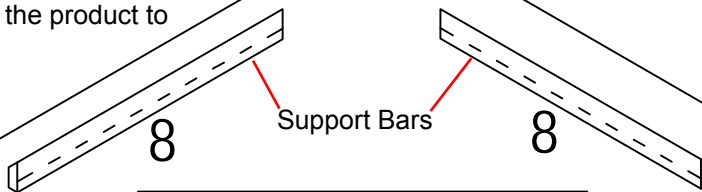

Draw a line the length of support bar

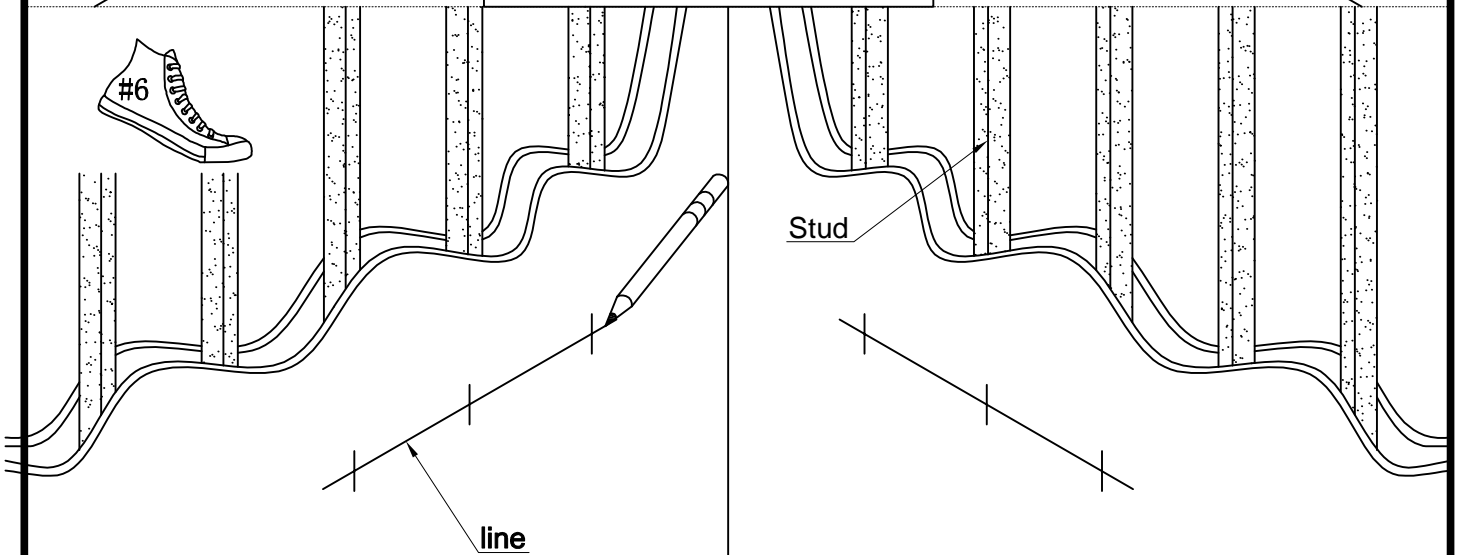

line

Stud

Find the studs behind the line and mark it

ASSEMBLY INSTRUCTIONS

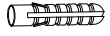
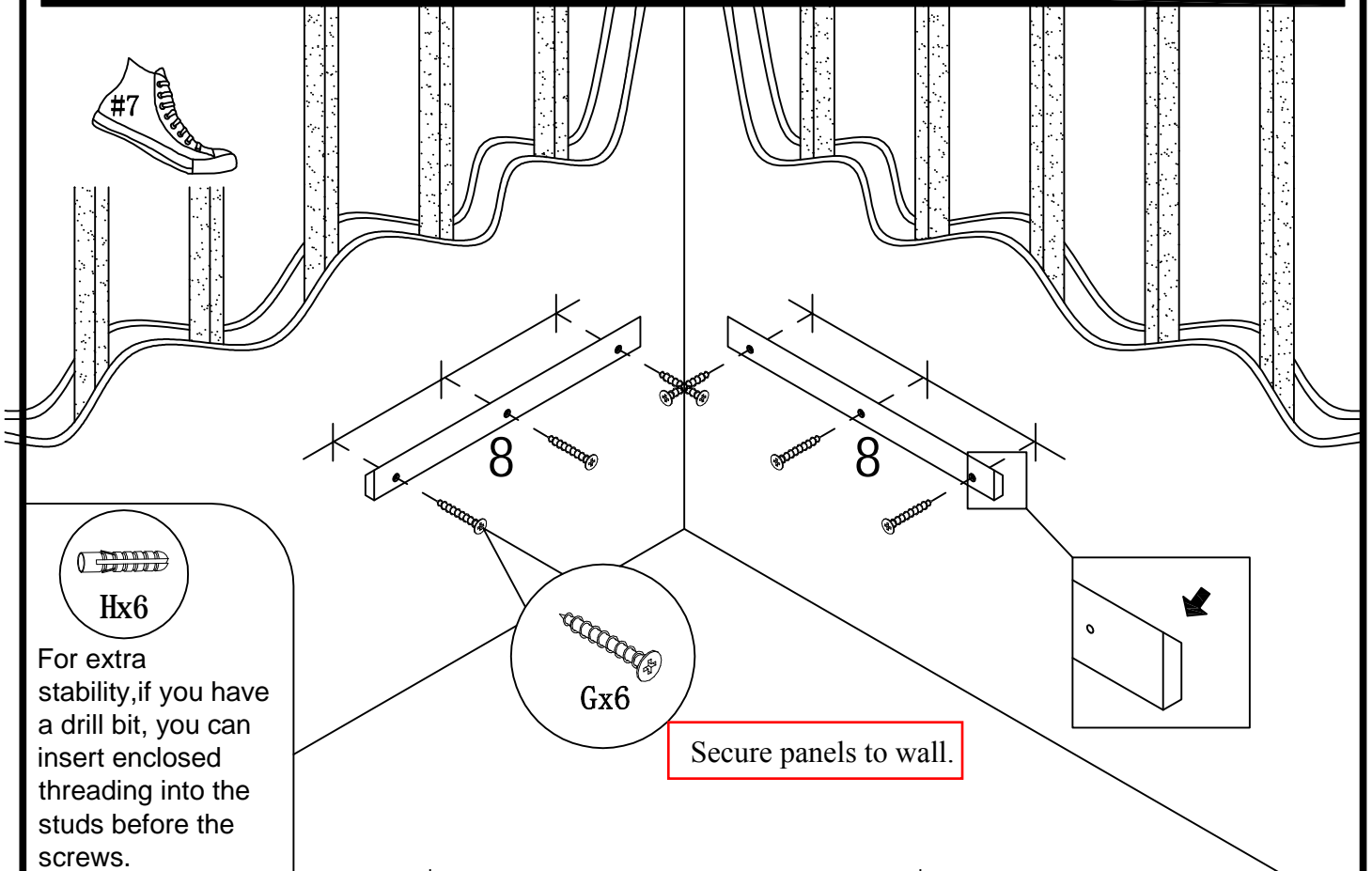

Hx6

For extra stability, if you have a drill bit, you can insert enclosed threading into the studs before the screws.



Gx6

Secure panels to wall.

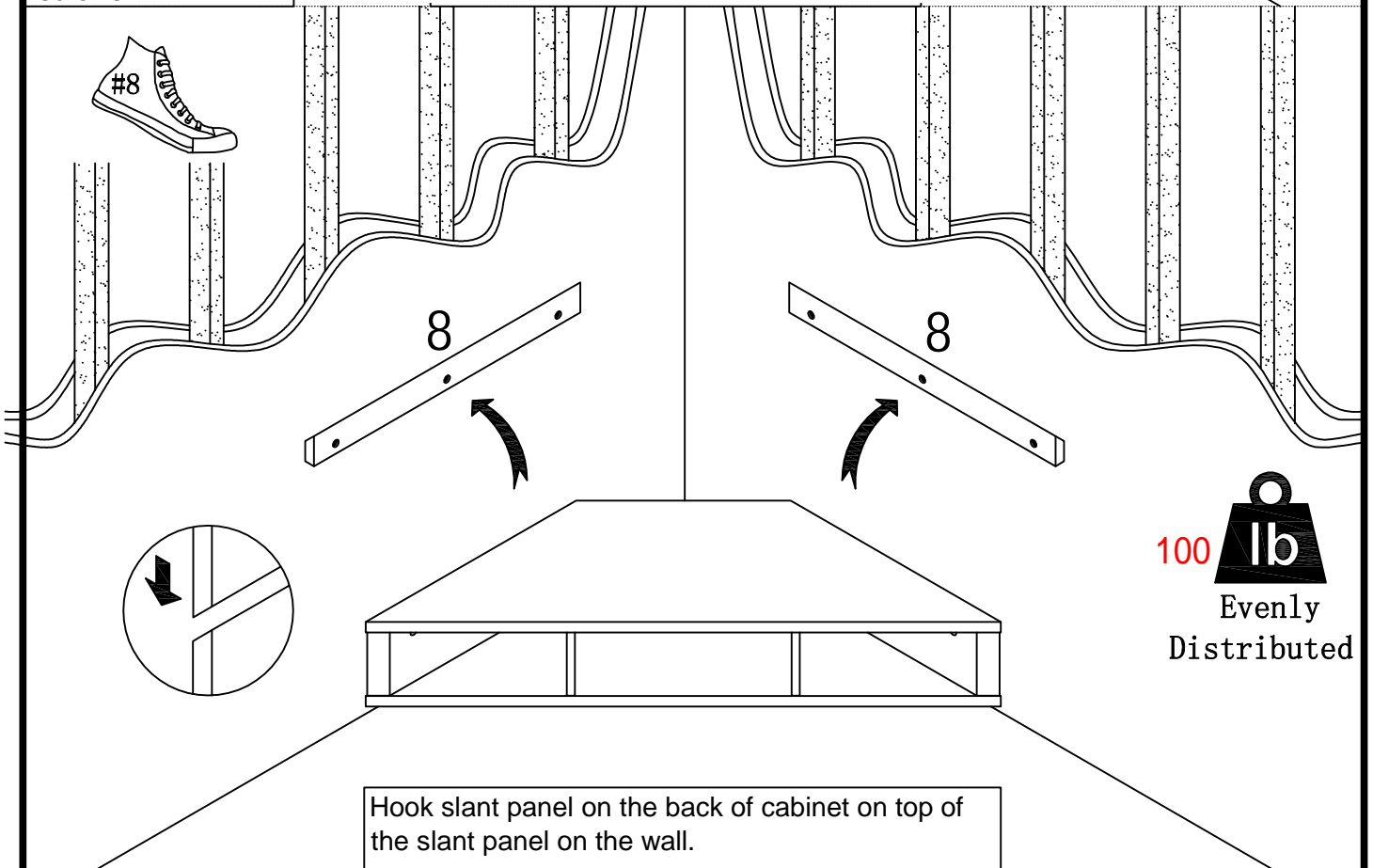

100  lb
Evenly
Distributed

Hook slant panel on the back of cabinet on top of the slant panel on the wall.