

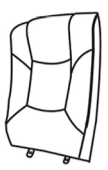









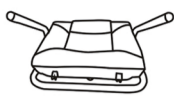

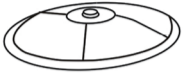
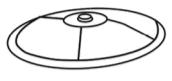

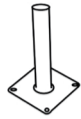







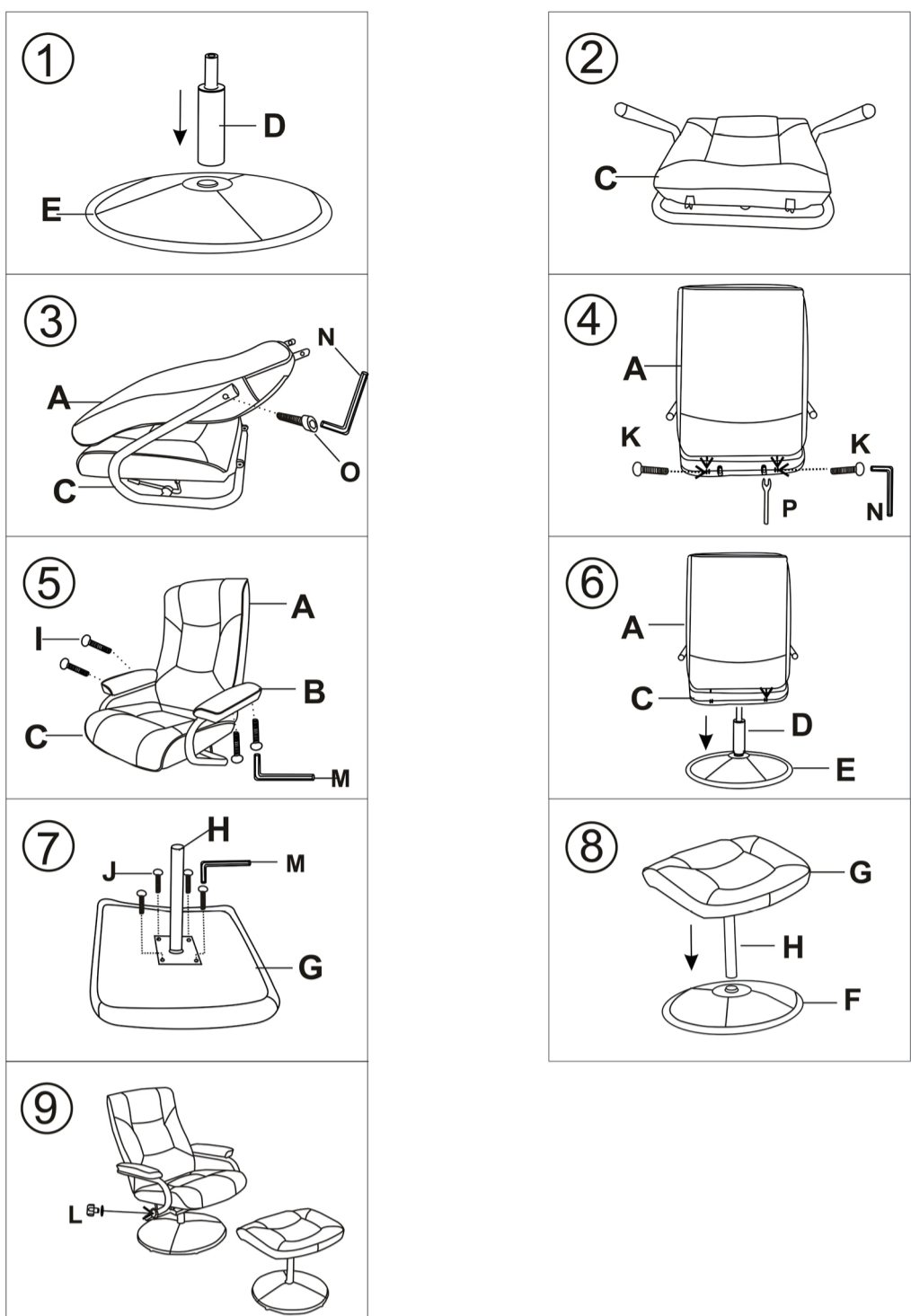

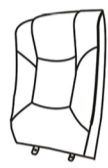

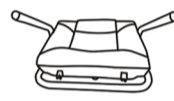

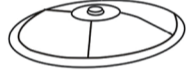
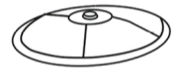
PRODUCT ASSEMBLY

A  X1	B  X2	C  X1	D  X1
E  X1	F  X1	G  X1	H  X1
I  M6X40 X4	J  M6X20 X4	K  M8X25 X2	L  X1
M  M6 X1	N  M8 X1	O  M8X50 X2	P  M8 X1

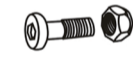
PRODUCT ASSEMBLY









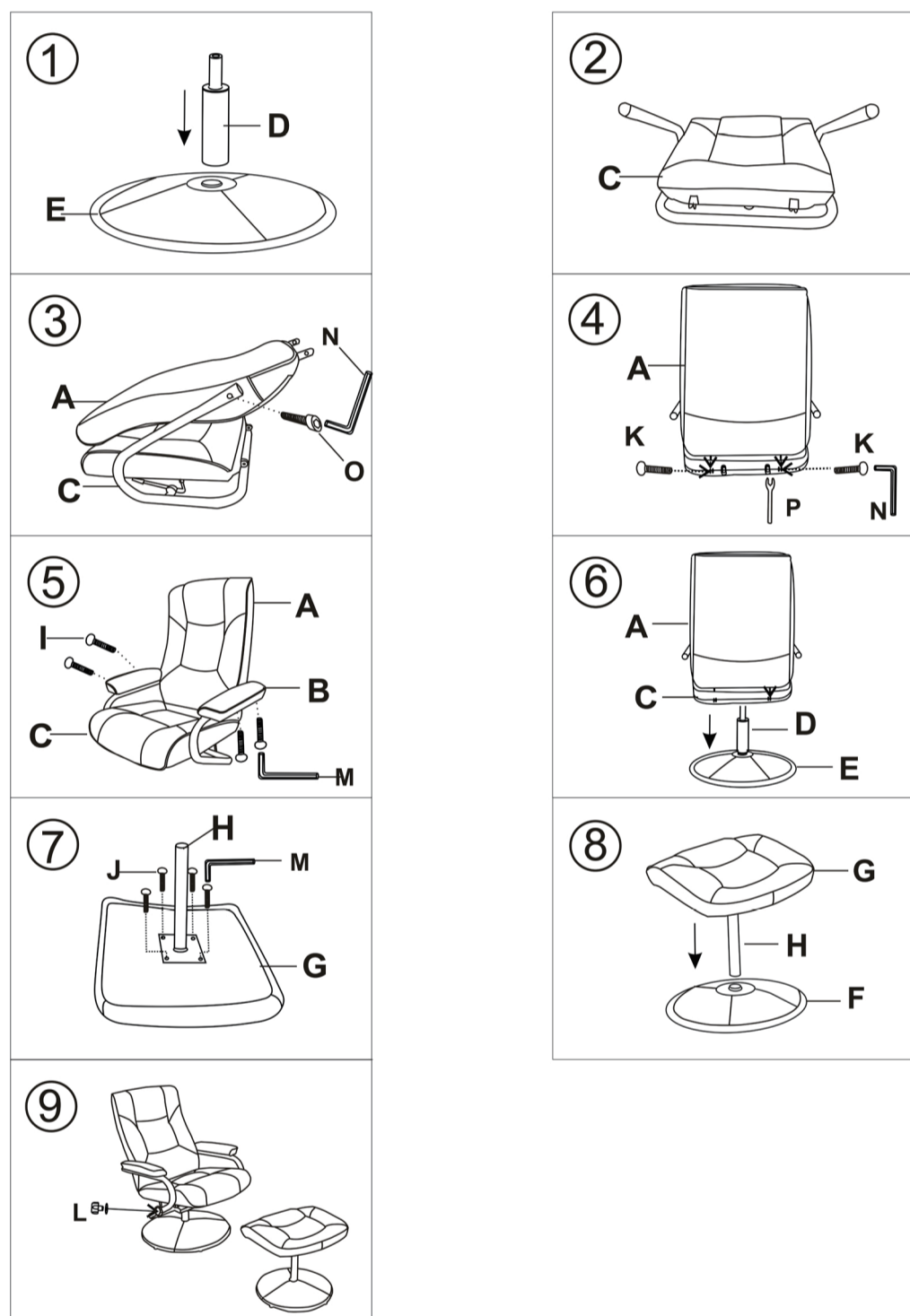





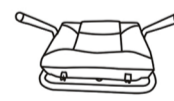

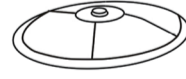
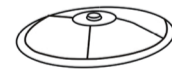
PRODUKT MONTAGE

A  X1	B  X2	C  X1	D  X1
E  X1	F  X1	G  X1	H  X1
I  M6X40 X4	J  M6X20 X4	K  M8X25 X2	L  X1
M  M6 X1	N  M8 X1	O  M8X50 X2	P  M8 X1

PRODUKT MONTAGE

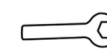

ASSEMBLAGE DU PRODUIT

A  X1	B  X2	C  X1	D  X1
E  X1	F  X1	G  X1	H  X1
I  M6X40 X4	J  M6X20 X4	K  M8X25 X2	L  X1
M  M6 X1	N  M8 X1	O  M8X50 X2	P  M8 X1

ASSEMBLAGE DU PRODUIT

