

**(D)** Montageanleitung  
»CT Chloe 2177 «

**(FR)** Notice de montage  
»CT Chloe 2177 «

**(NL)** Handleiding voor de montage  
»CT Chloe 2177 «

**(CZ)** Montážní návod  
»CT Chloe 2177 «

**(HU)** Szerelési útmutató  
»CT Chloe 2177 «

**(TR)** Montaj talimati  
»CT Chloe 2177 «

**(GB)** Assembly instructions  
»CT Chloe 2177 «

**(IT)** Istruzioni di montaggio  
»CT Chloe 2177 «

**(PL)** Instrukcja montażu  
»CT Chloe 2177 «







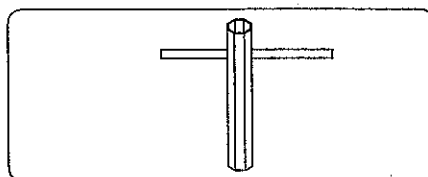
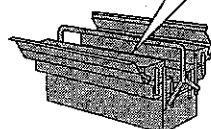

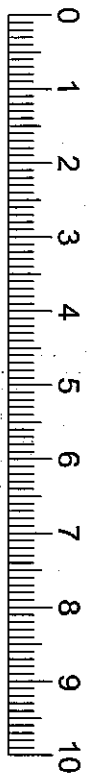





**(SK)** Návod na montáž  
»CT Chloe 2177 «

**(RO)** Instrucțiuni de montaj  
»CT Chloe 2177 «

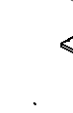

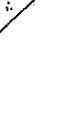

**(RU)** Инструкция по монтажу  
»CT Chloe 2177 «

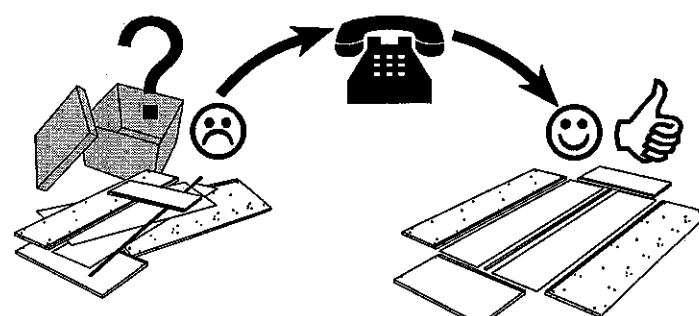

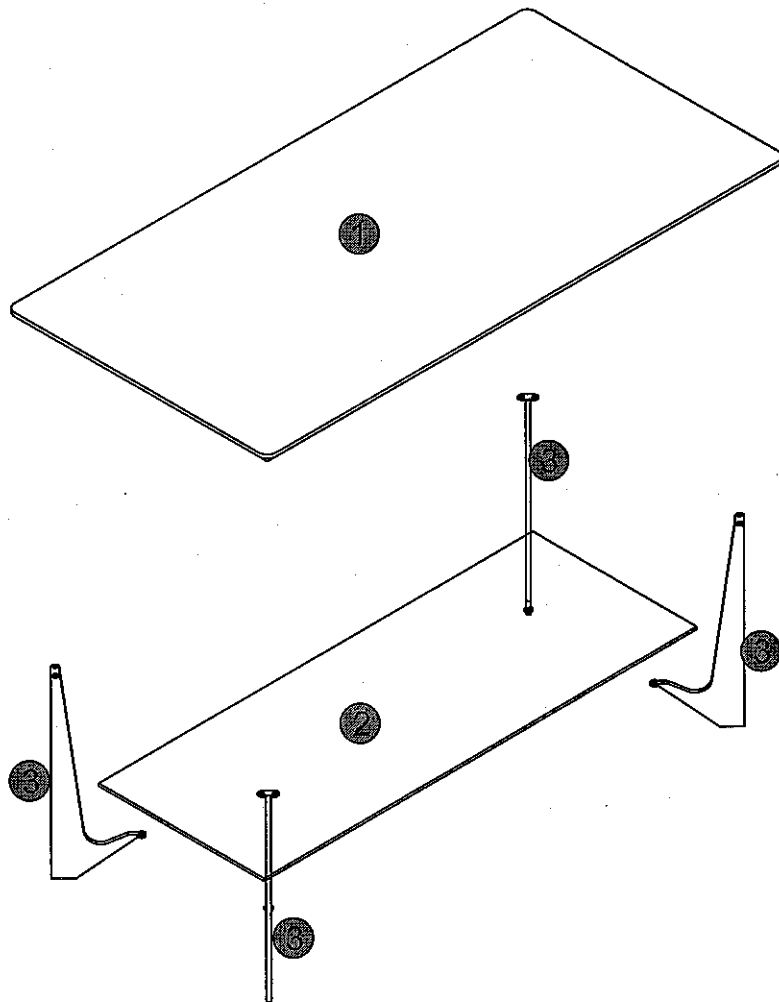





Service · Assistenza · Dienstverlening · Serwis Servis · Szerviz · Сервисная служба	
Name · Nom · Nome · Naam Nazwa · Jméno · Názov · Név Denumire · Ísim · Название	CT Chloe
Nr. · No. · N° · Номер · Č · Sz	-
Typ · Type · Tip · Típus · Тип Тип	Couchtisch
               	

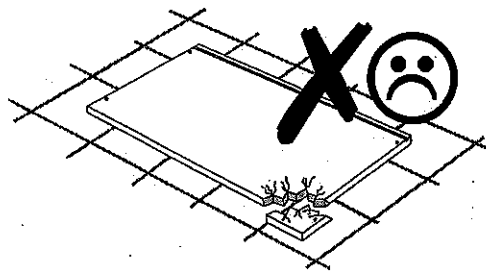
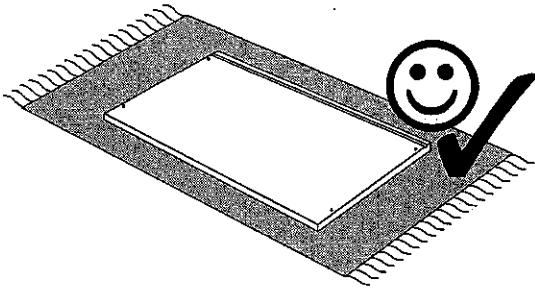



<b>A</b>  M6*14 4x	<b>B</b>  M6*16 8x	<b>C</b>  8x	<b>D</b>  1x
--	--	---	---

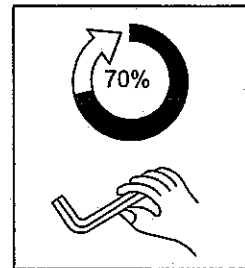
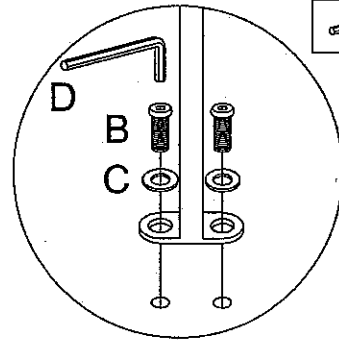
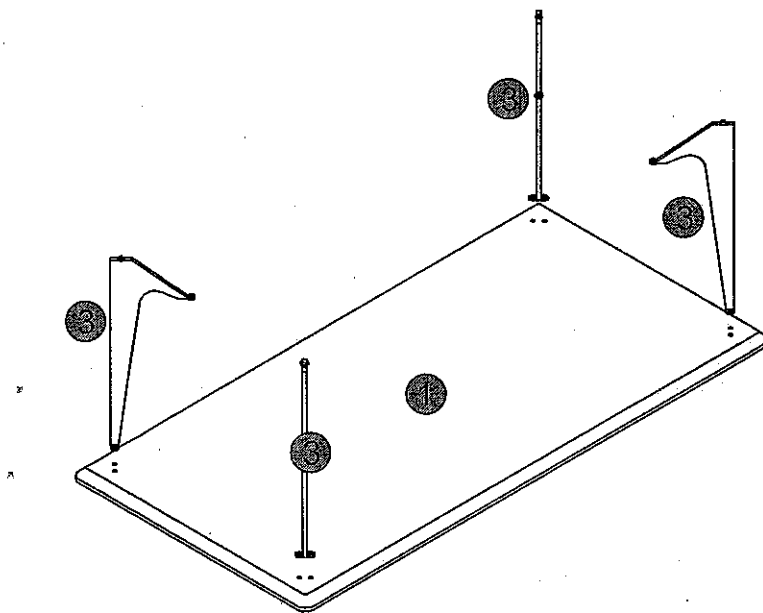

	BX8
	CX8
	DX1



	AX4
	DX1

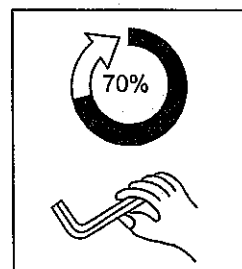
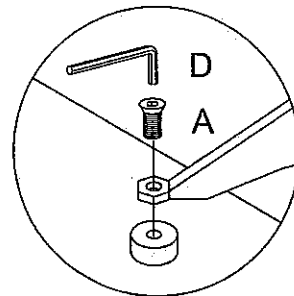
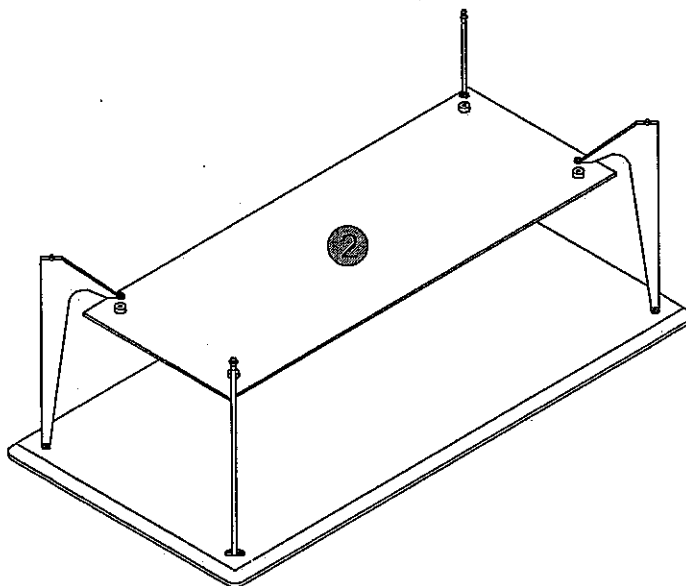

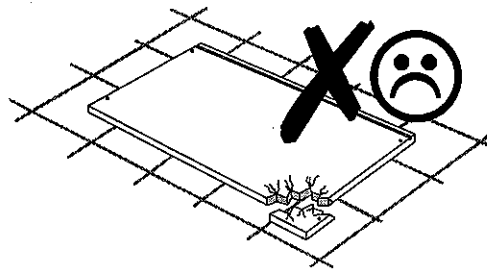
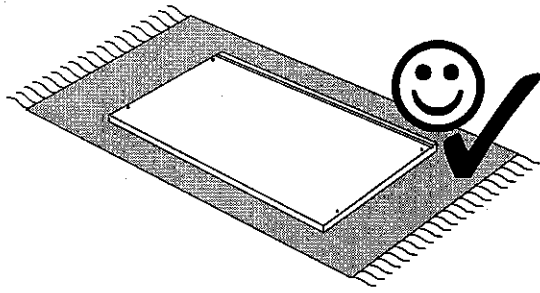

3

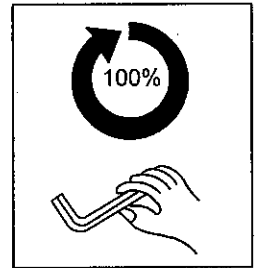
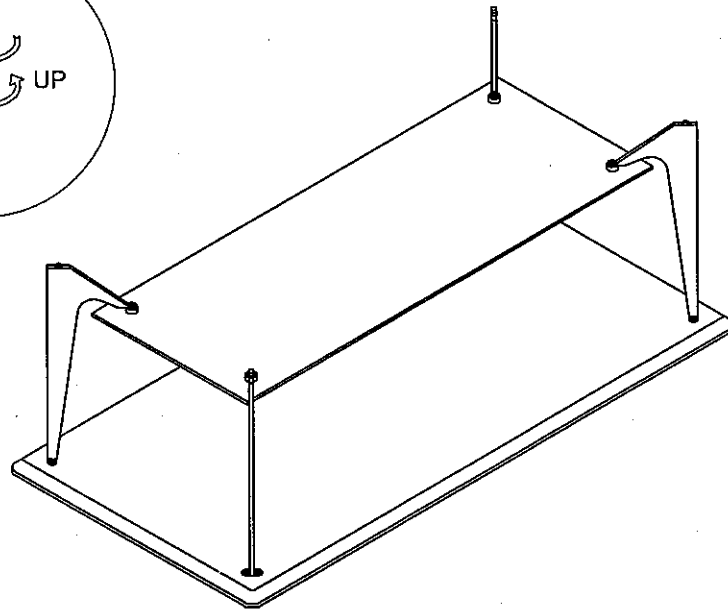
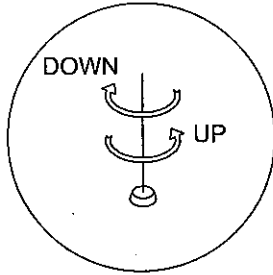

4

