











Installation instruction

# Double coat and hat rack

## Accessories

Accessories name	legend	number
A		12
B		4
C		2
D		1
E		4
F		2
G		2
H		2
I		2
J		2
K		4

## caution

**BEFORE INSTALLING AND USING THE PRODUCT,  
PLEASE READ THIS MANUAL CAREFULLY  
THEN THEY ASSEMBLE THE PRODUCT**

1. Do not touch the sharp cutting surface of the steel pipe
2. Please confirm whether all parts are complete
3. Please be sure to assemble according to the installation order in the instruction
4. Because of our negligence

Parts were found to be in short supply during your assembly  
Please contact Wangwang online customer service immediately to inform us  
of the missing part code We apologize for any inconvenience caused  
and thank you for your cooperation.

## Installation

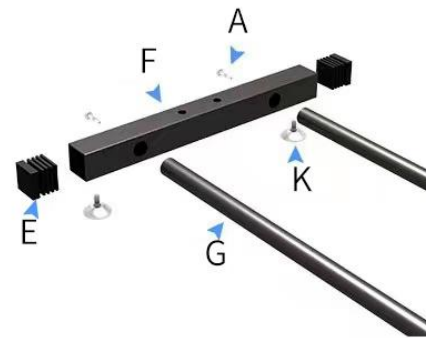

1. Take A\*4, E\*4, G\*2, F\*2, K\*4, as shown in figure assembly

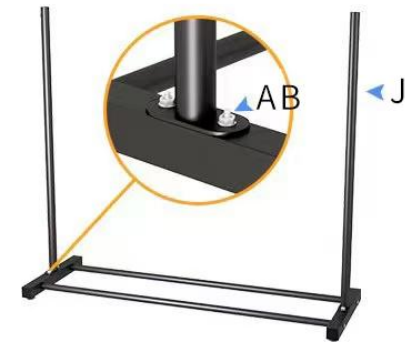

2. Take A\*4, B\*4, J\*2, as shown in figure assembly

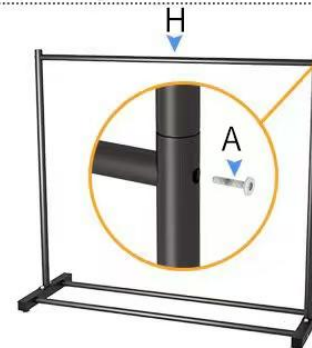

3. Take A\*2, H\*1, as shown in figure assembly

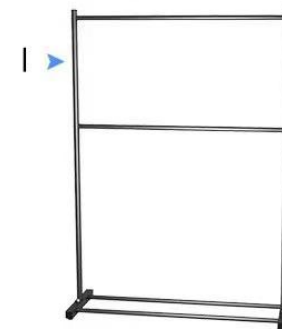

4. Repeat the above steps

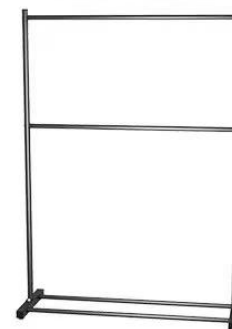

5. The installation is complete, as shown in the figure

The G and H of 60 and 100 models are the same size