

USER MANUAL



Any questions or suggestions, please contact us via

 LemodorFurniture@gmail.com

REMINDER BEFORE INSTALLATION





- Please follow each step in the installation manual.
- Please check all parts and components to ensure that there are no damages or missing items before starting the assembly. If you have any problems, please feel free to contact us.
- Some parts may contain sharp edges. Wear protective gloves if necessary during assembly.
- When using power tools, please adjust the gear to the minimum, otherwise it will cause damage to the parts.
- Clean the surface of the product with a damp cloth and dry thoroughly. Do not clean with abrasive materials, bleach, or solvents.
- Store the chair in a dry, sheltered place when not in use.





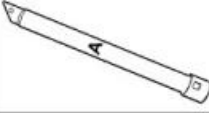
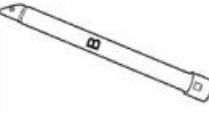
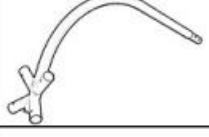
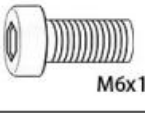





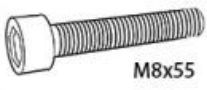

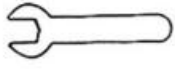
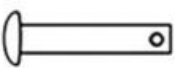
ASSEMBLY SUGGESTIONS

Two people

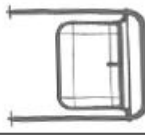

A		x2
B		x2
C		x1
D		x4
E		x4
F		x1
G		x1

H		x2
I		x2
J		x1
K		x1
L		x1
M		x1
N		x1

O		x1
P		x1
Q		x1
R		x4
T		x1
U		x1

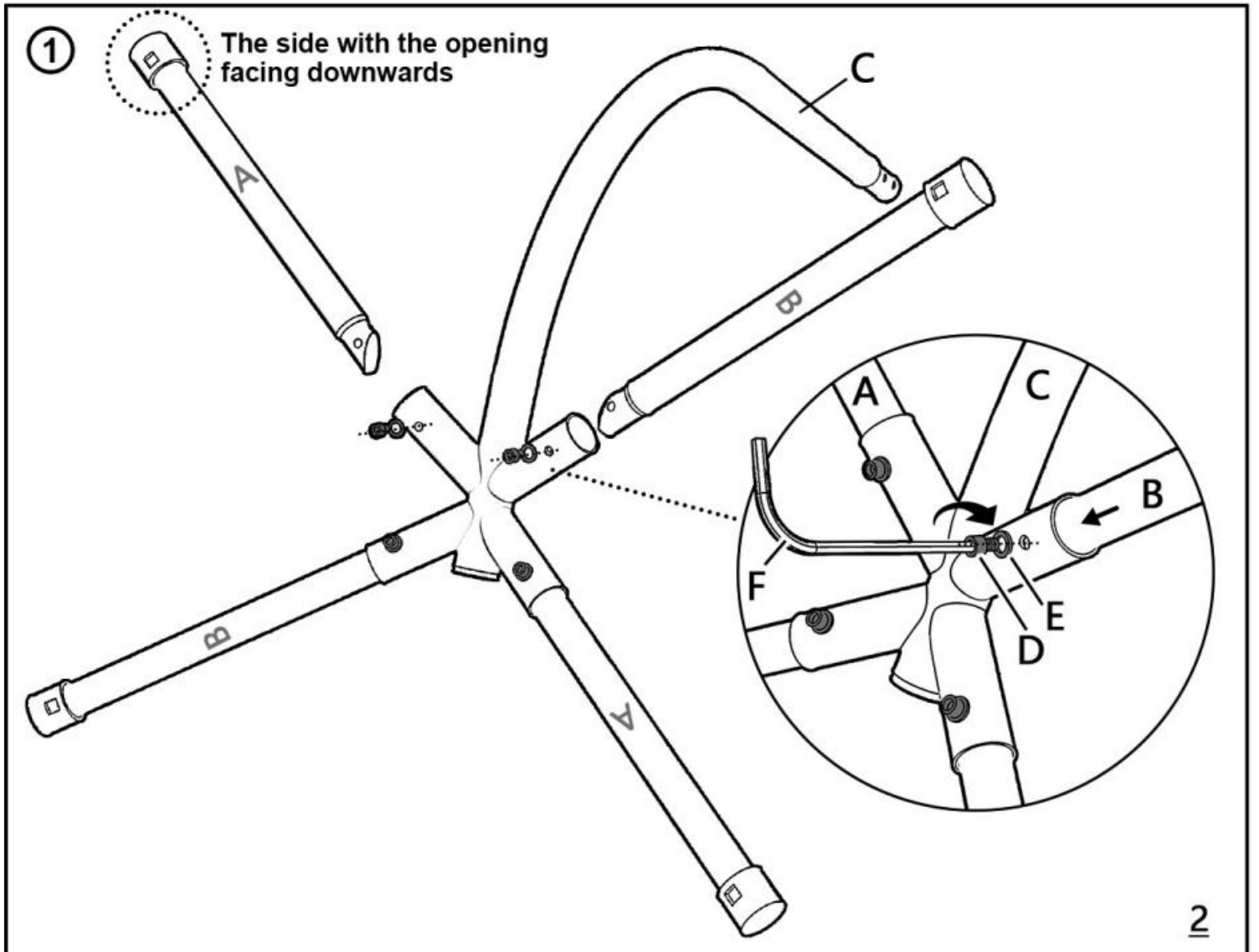

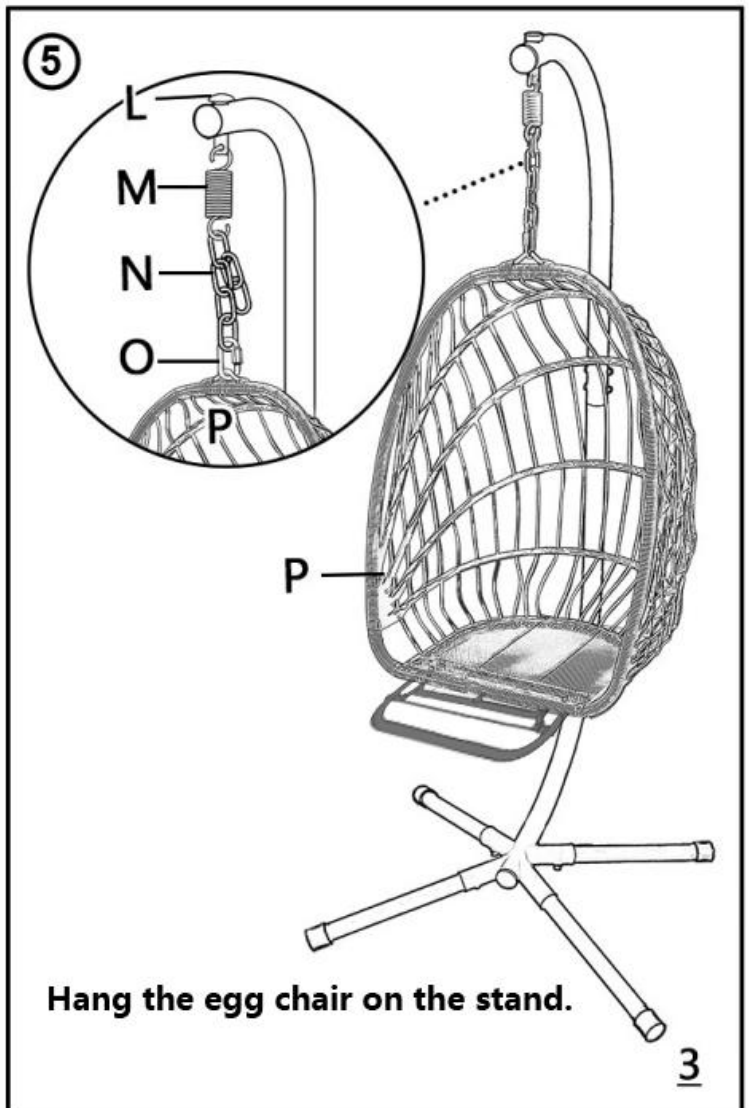
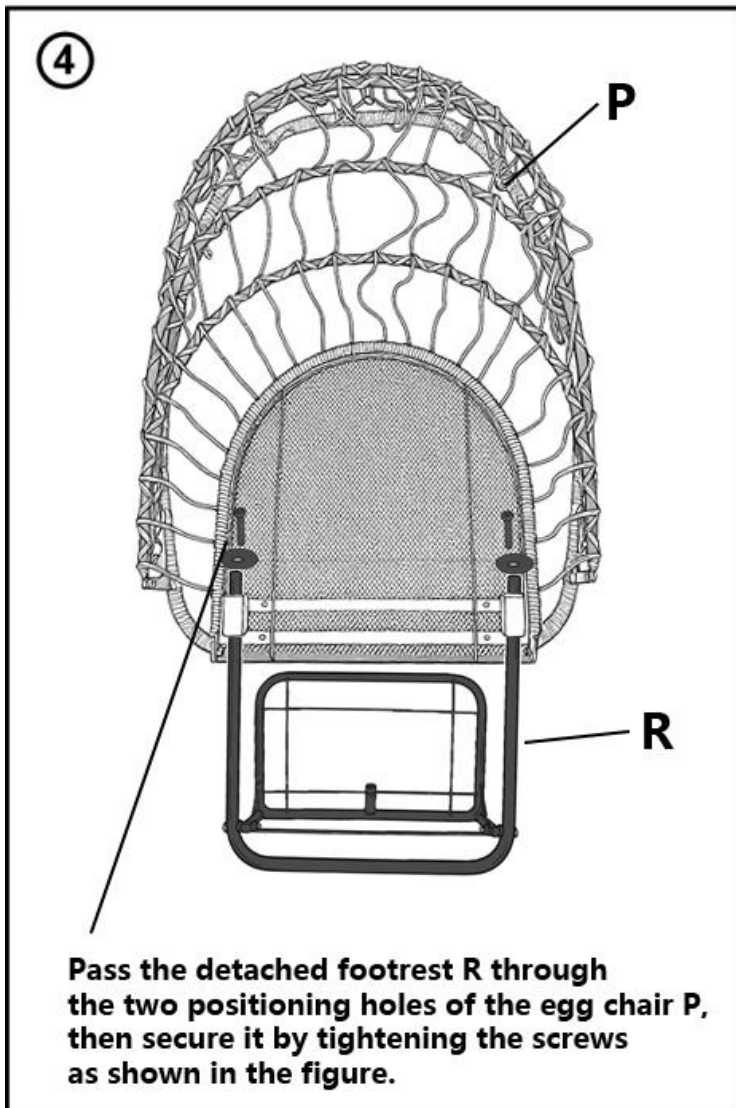
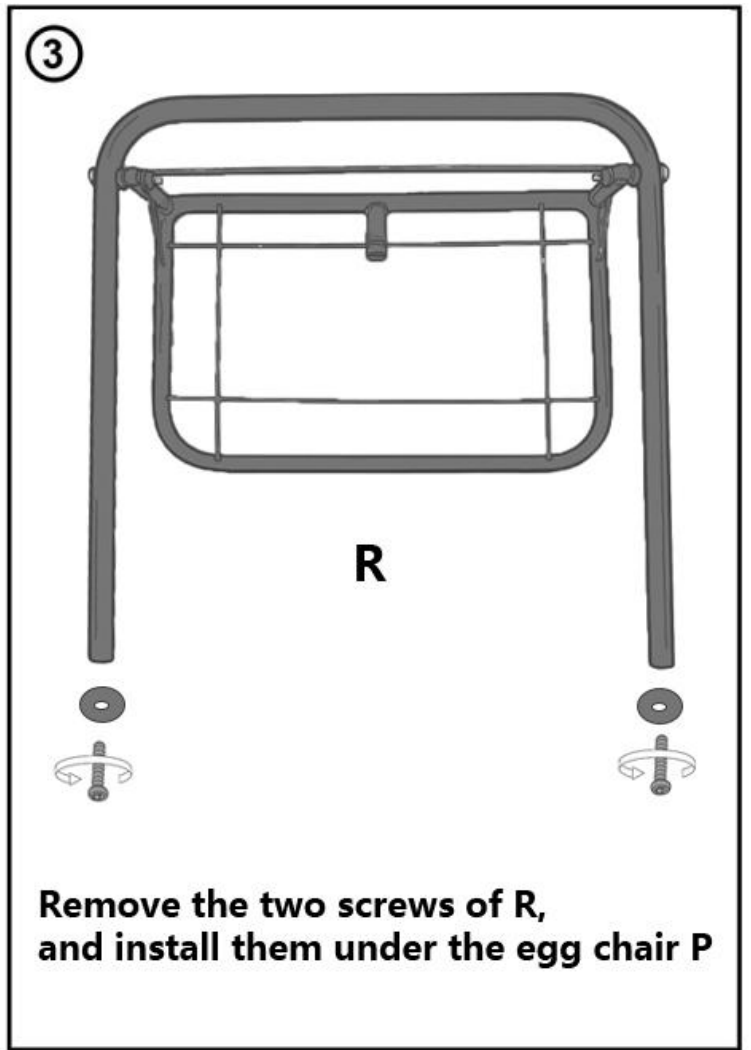
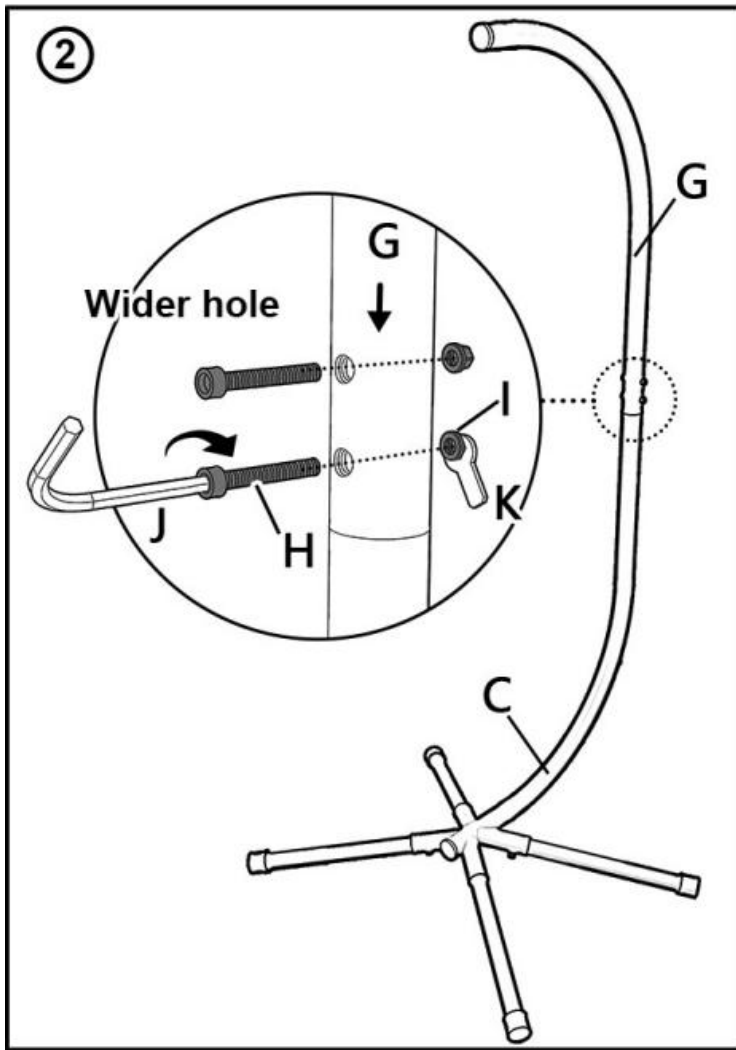

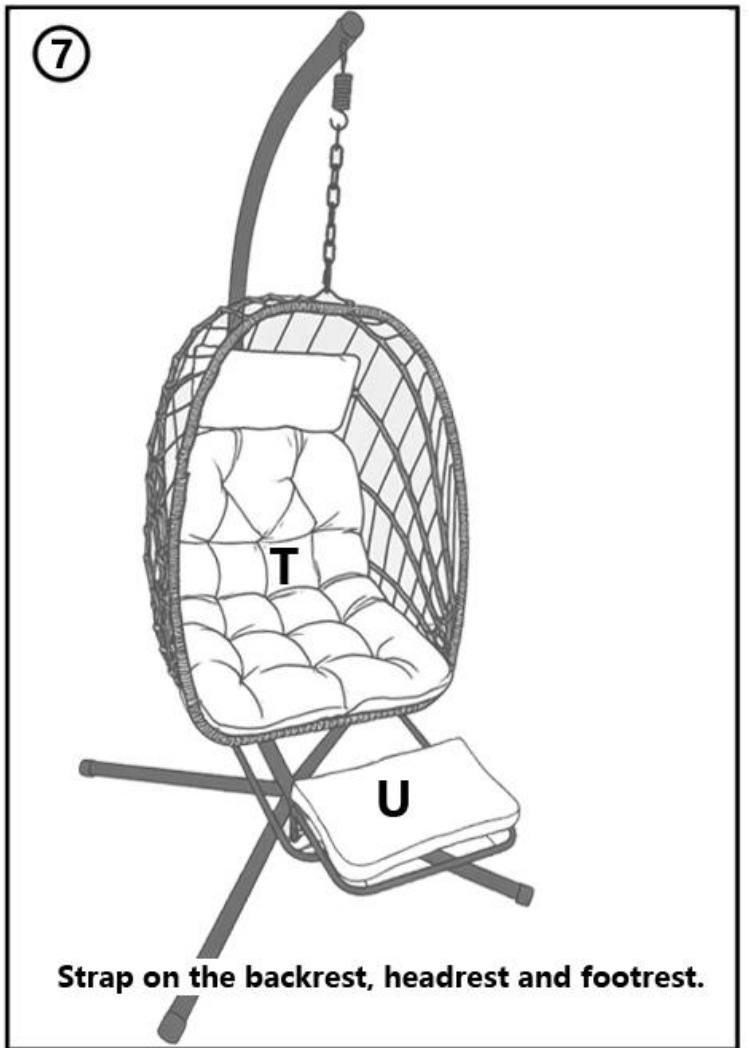
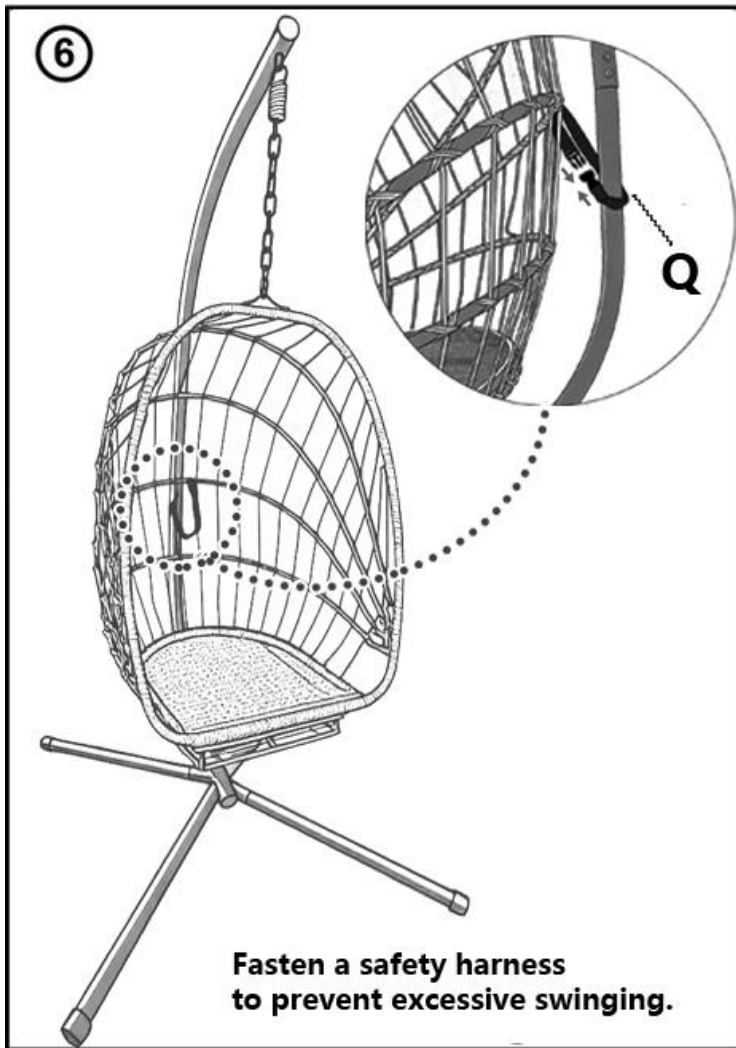

Notice:

1. Fold up the footrest when not in use.
2. Sit on the egg chair first, then unfold the footrest.
3. When in use, please sit as far in as possible to avoid the egg chair losing balance.