

TWIN OVER TWIN BUNK BED  
ASSEMBLY INSTRUCTIONS  
SKU MF286424

Weight Limit  
250 Lbs

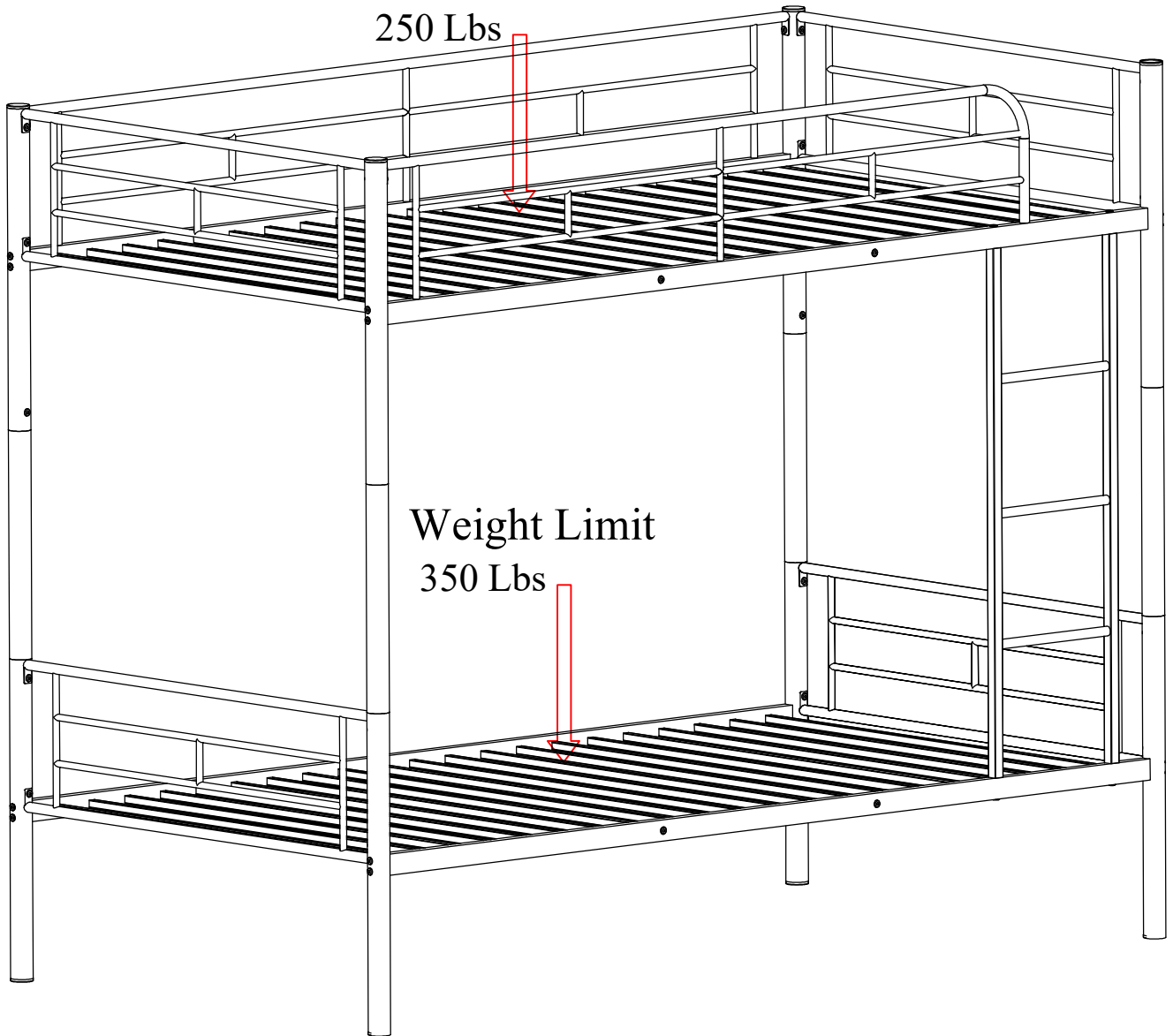

Weight Limit  
350 Lbs

TWIN OVER TWIN BUNK BED  
ASSEMBLY INSTRUCTIONS  
SKU MF286424



SAFETY WARNING



1. This bed is designed for use only mattress (es) meeting the following specifications on the upper bunk, and lower bunk:

Upper bunk (bunk bed and tribed included)

Bed type	Length	Width	Thickness
Twin	74" – 75"	38½"	6" max

Lower bunk

Bed type	Length	Width	Thickness
Twin	74" – 75"	38½"	8"

2. Replacement parts, including additional guardrails, maybe obtained from any of our (GIGACLOUD TECHNOLOGY(USA) INC. 18961 ARENTH AVENUE, CITY OF INDUSTRY, CA, 91748) dealers.

3. Follow the information on the warnings appearing on the upper bunk bed end structure and on the carton. Do not remove warning label from bed.

4. Always use the recommended size mattresses or mattress supports, or both, to help prevent the likelihood of entrapment or falls.

5. Surface of mattress must be at least 5" (127mm) below the upper edge of guardrails.

6. Do not allow children under 6 years of age to use the upper bunk.

7. Periodically check and ensure that the guardrail, ladder, and other components are in their proper position, free from damage, and that all connectors are tight.

8. Do not allow horseplay on or under the bed and prohibit jumping on the bed.

9. Always use the ladder for entering and leaving the upper bunk.

10. Do not use substitute part. Contact the manufacture or dealer for replacement part.

11. Use of a night light may provide added safety precaution for a child using the upper bunk.

12. Always use guardrails on both long sides of the upper bunk. If the bunk bed will be placed next to the wall, the guardrail that runs the full length of the bed should be placed against the wall to prevent entrapment between the bed and wall.

13. The use of water or sleep flotation mattresses is prohibited.

14. STRANGULATION HAZARD – Never attach or hang items to any part of the bunk bed that are not designed for use with the bed; for example, but not limited to, hook, belts and jump ropes.

15. Keep these instruction for future reference.

16. Prohibit more than one person on upper bunk

17. We recommend assembling your bunk bed on the shipping carton to protect your floor or carpet.

18. Be certain all staples are out of the box before beginning assembly on the shipping carton.

TWIN OVER TWIN BUNK BED  
ASSEMBLY INSTRUCTIONS  
SKU MF286424

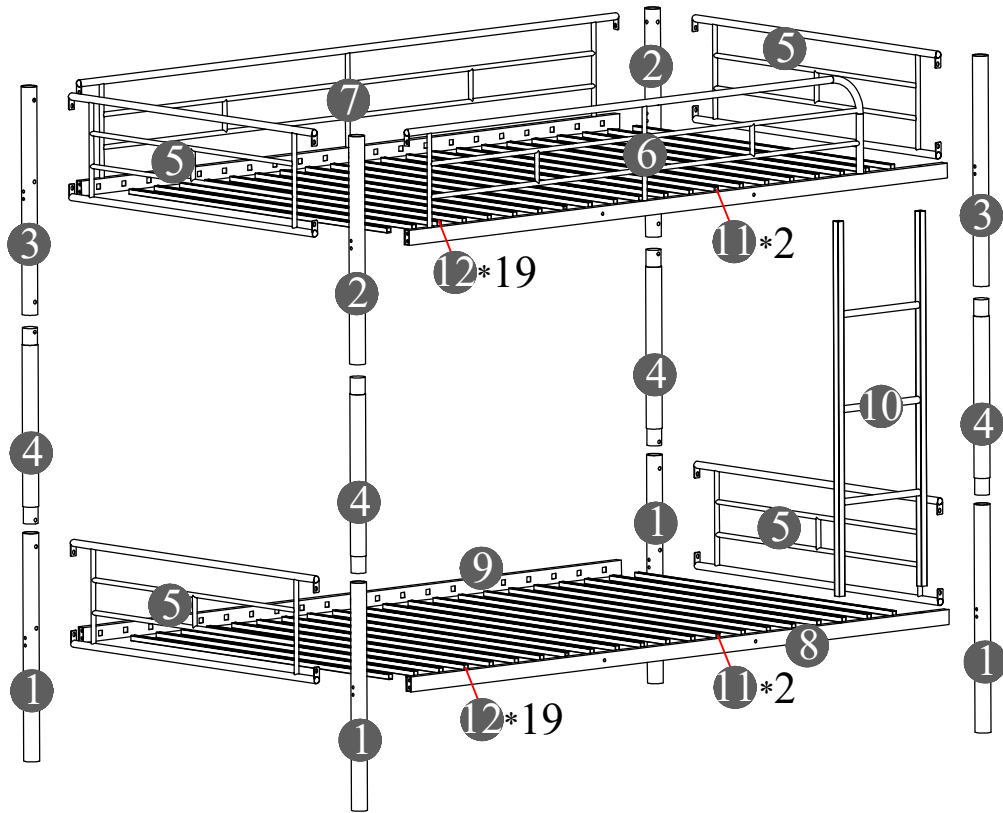

DETAIL VIEW

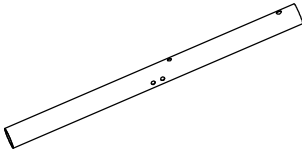
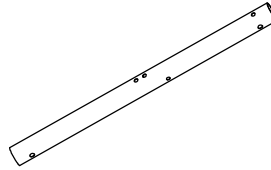
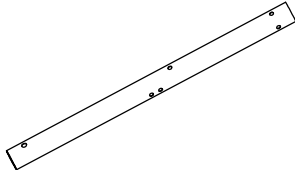
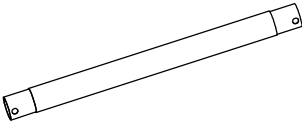
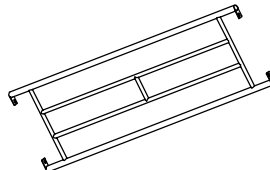
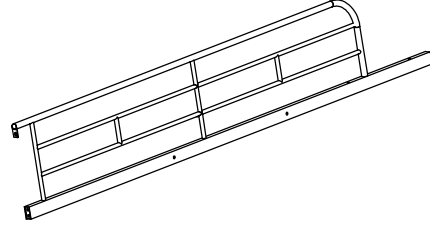
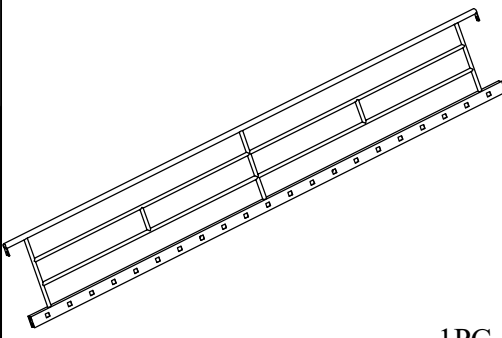
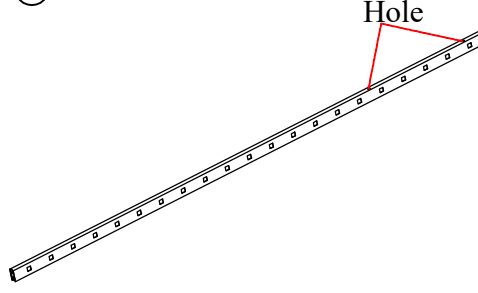
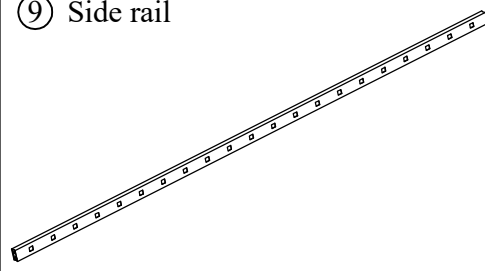
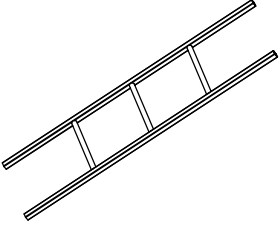
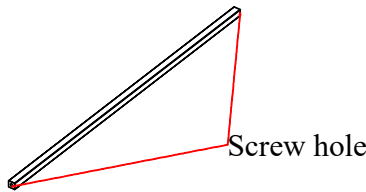
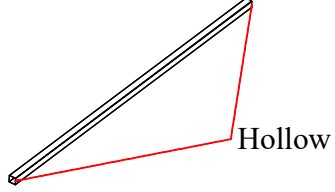

**TWIN OVER TWIN BUNK BED  
ASSEMBLY INSTRUCTIONS  
SKU MF286424  
PART LIST**

<p>① Post</p>  <p style="text-align: right;">4PCS</p>	<p>② Post</p>  <p style="text-align: right;">2PCS</p>	<p>③ Post</p>  <p style="text-align: right;">2PCS</p>
<p>④ Post</p>  <p style="text-align: right;">4PCS</p>	<p>⑤ End guard rail</p>  <p style="text-align: right;">4PCS</p>	<p>⑥ Guard rail</p>  <p style="text-align: right;">1PC</p>
<p>⑦ Guard rail</p>  <p style="text-align: right;">1PC</p>	<p>⑧ Side rail</p>  <p style="text-align: right;">1PC</p>	<p>⑨ Side rail</p>  <p style="text-align: right;">1PC</p>
<p>⑩ Ladder</p>  <p style="text-align: right;">1PC</p>	<p>⑪ Slats</p>  <p style="text-align: right;">4PCS</p>	<p>⑫ Slats</p>  <p style="text-align: right;">38PCS</p>

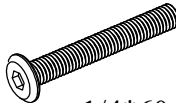
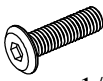
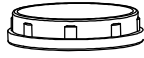
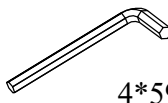
**HARDWARE LIST**

<p>Ⓐ Bolts</p>  <p style="text-align: center;">1/4*60 20PCS</p>	<p>Ⓑ Bolts</p>  <p style="text-align: center;">1/4*15 31PCS</p>	<p>Ⓒ End cap</p>  <p style="text-align: center;">Ø42 16PCS</p>	<p>Ⓓ Allen key</p>  <p style="text-align: center;">4*59 1PC</p>	<p>Ⓔ Connect wall</p>  <p style="text-align: center;">1/4*40 2 SET</p>	<p>Ⓕ Hex nut</p>  <p style="text-align: center;">1/4 4PCS</p>
---	--	---	---	---	--

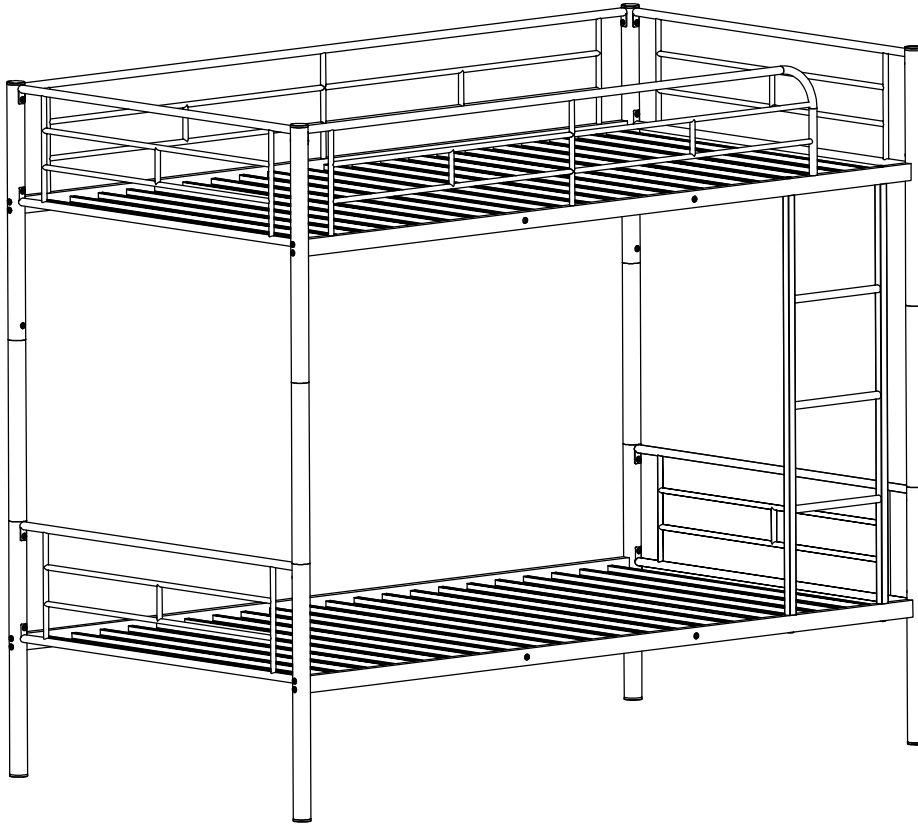

TWIN OVER TWIN BUNK BED  
 ASSEMBLY INSTRUCTIONS  
 SKU MF286424

OPTION A STEP 1-7

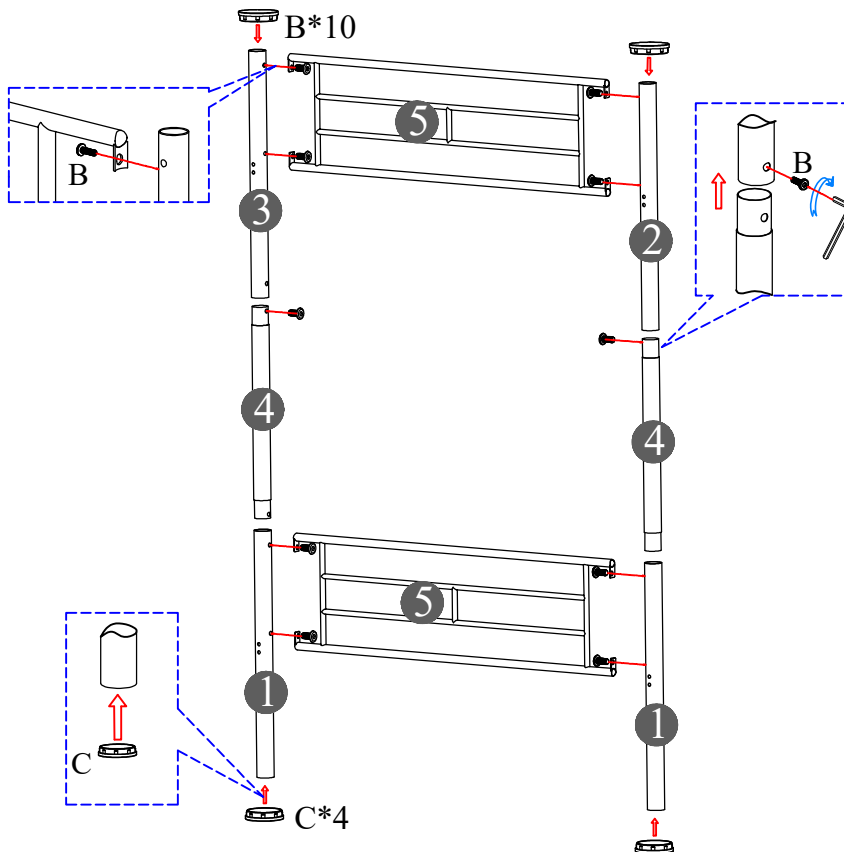

STEP 1 : Following below illustration Assembly Frame #1. Using hardware #B, #C connect #1 , #2, #3, #4 with #5 to complete Frame #1.





(B)	10PCS
	1/4*15
(C)	4PCS
	Ø42
(D)	1PC
	4*59

NOTE: In this step, DO NOT tighten any bolt until you connect all part together.

# TWIN OVER TWIN BUNK BED ASSEMBLY INSTRUCTIONS SKU MF286424

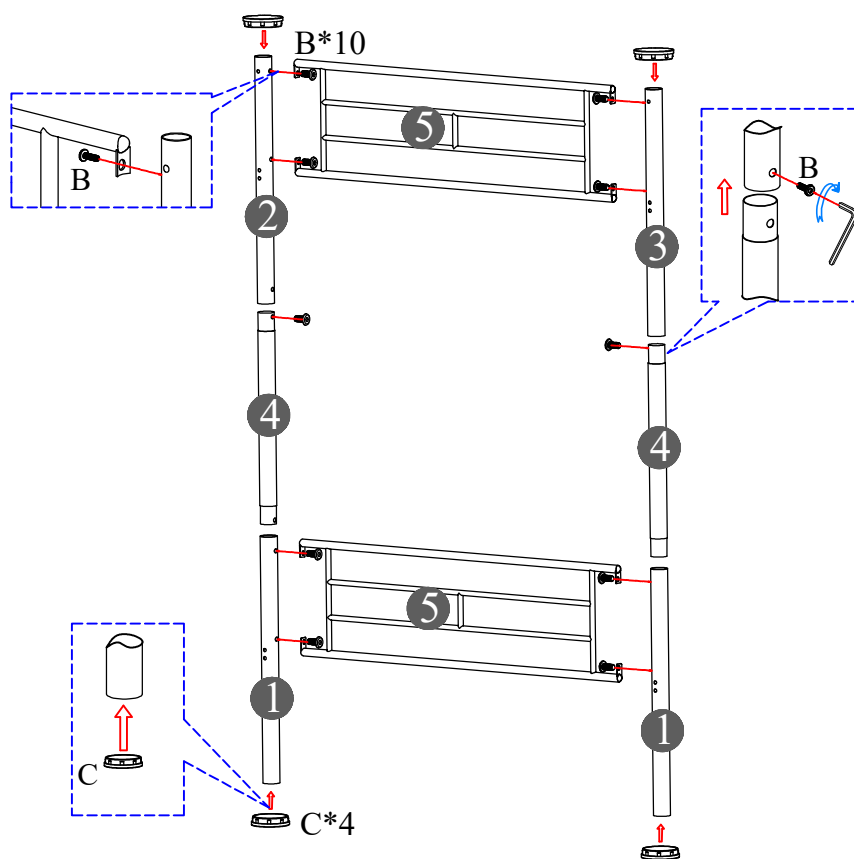
**STEP 2 :** Following below illustration Assembly Frame #2. Using hardware #B, #C connect #1 , #2, #3, #4 with #5 to complete Frame #2.





(B)	10PCS
	1/4*15
(C)	4PCS
	Ø42
(D)	1PC
	4*59

**NOTE:**In this step, DO NOT tighten any bolt until you connect all part together.

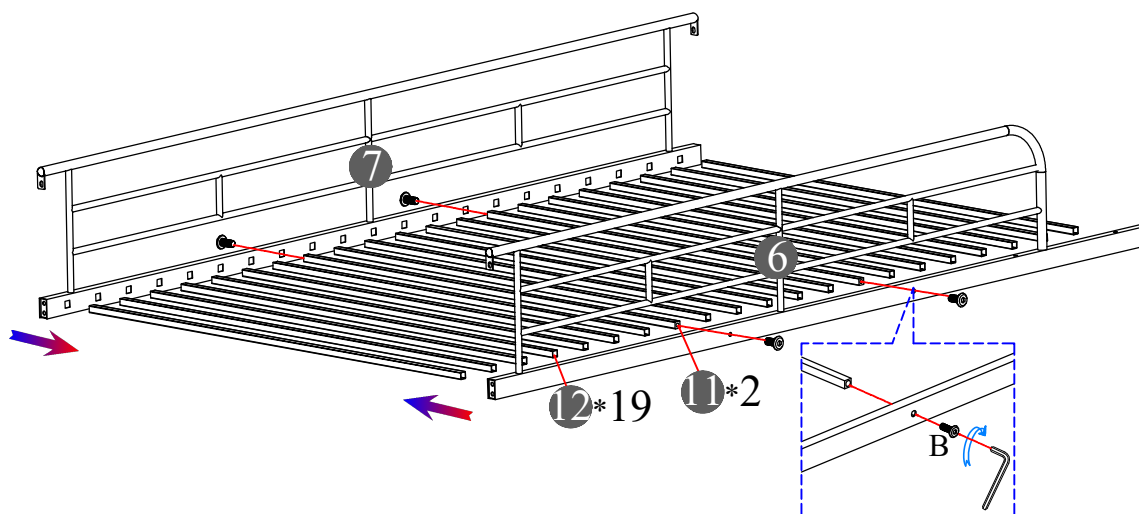
**STEP 3 :** Following below illustration Assembly Frame #3. Using hardware #B connect #6, #7 with #11, #12 to complete Frame #3.





(B)	4PCS
	1/4*15
(D)	1PC
	4*59

**NOTE:**In this step, DO NOT tighten any bolt until you connect all part together.

# TWIN OVER TWIN BUNK BED ASSEMBLY INSTRUCTIONS SKU MF286424

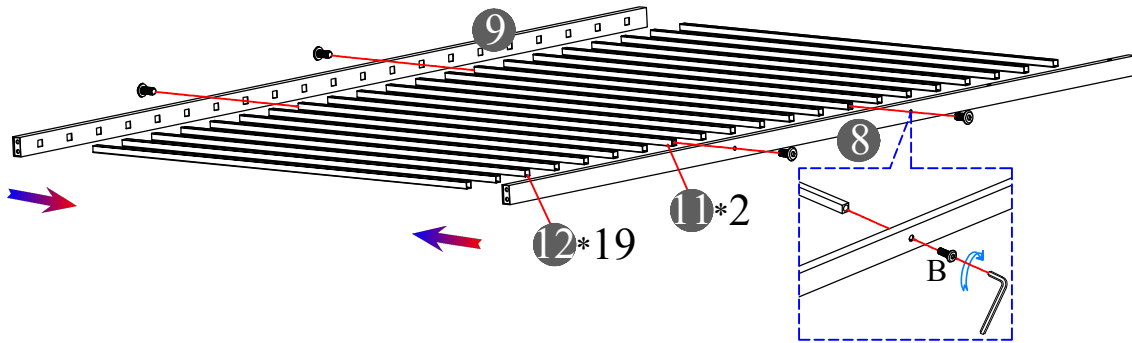
**STEP 4 :** Following below illustration Assembly Frame #4.  
Using hardware #B connect #8, #9 with #11, #12 to complete Frame #4.





(B)	4PCS
	1/4*15
(D)	1PC
	4*59

**NOTE:**In this step, DO NOT tighten any bolt until you connect all part together.

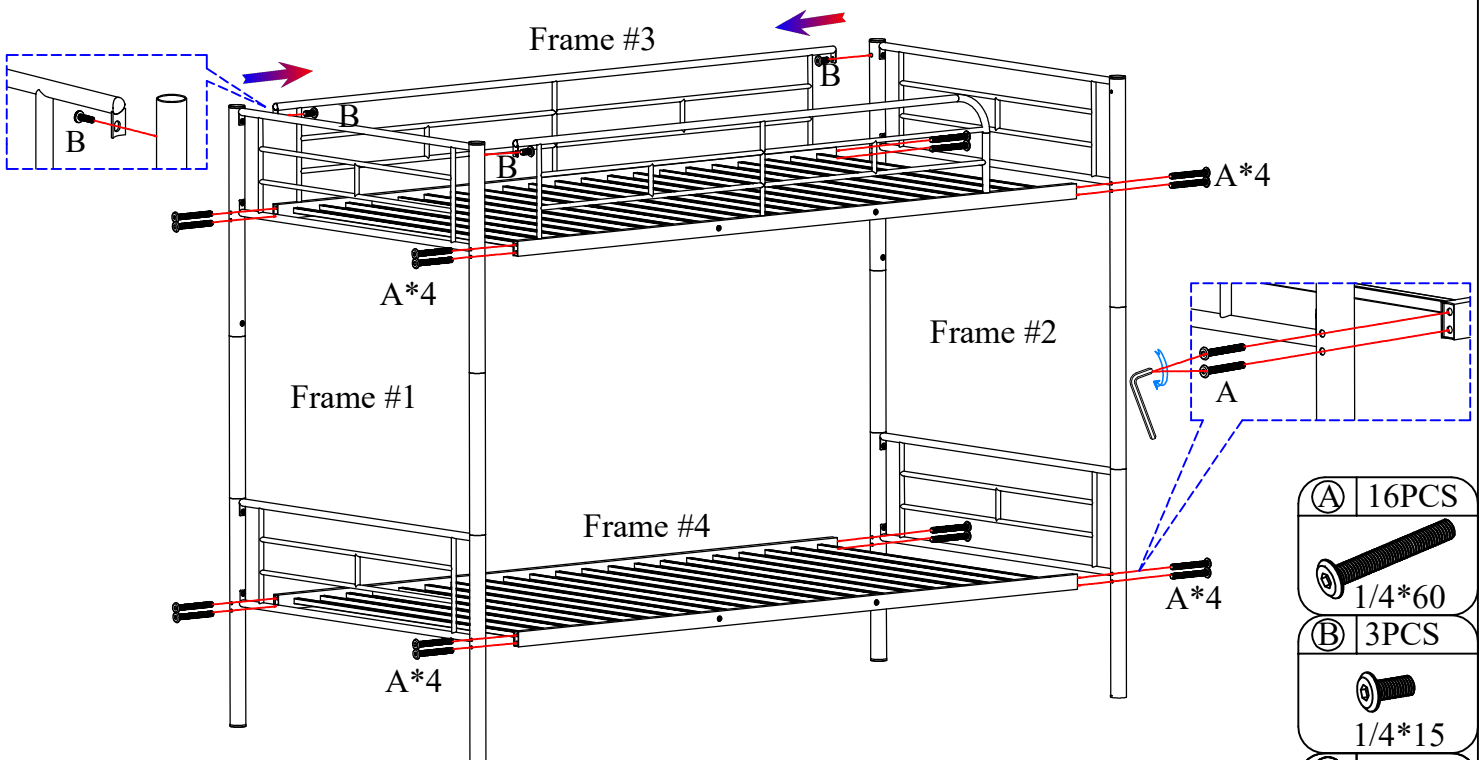
**STEP 5 :** Following below illustration Assembly Frame #5.  
Using hardware #A, #B connect Frame #1, Frame #2 with Frame #3, Frame #4 to complete Frame #5.



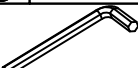

(A)	16PCS
	1/4*60
(B)	3PCS
	1/4*15
(D)	1PC
	4*59

**NOTE:**In this step, DO NOT tighten any bolt until you connect all part together.

TWIN OVER TWIN BUNK BED  
 ASSEMBLY INSTRUCTIONS  
 SKU MF286424

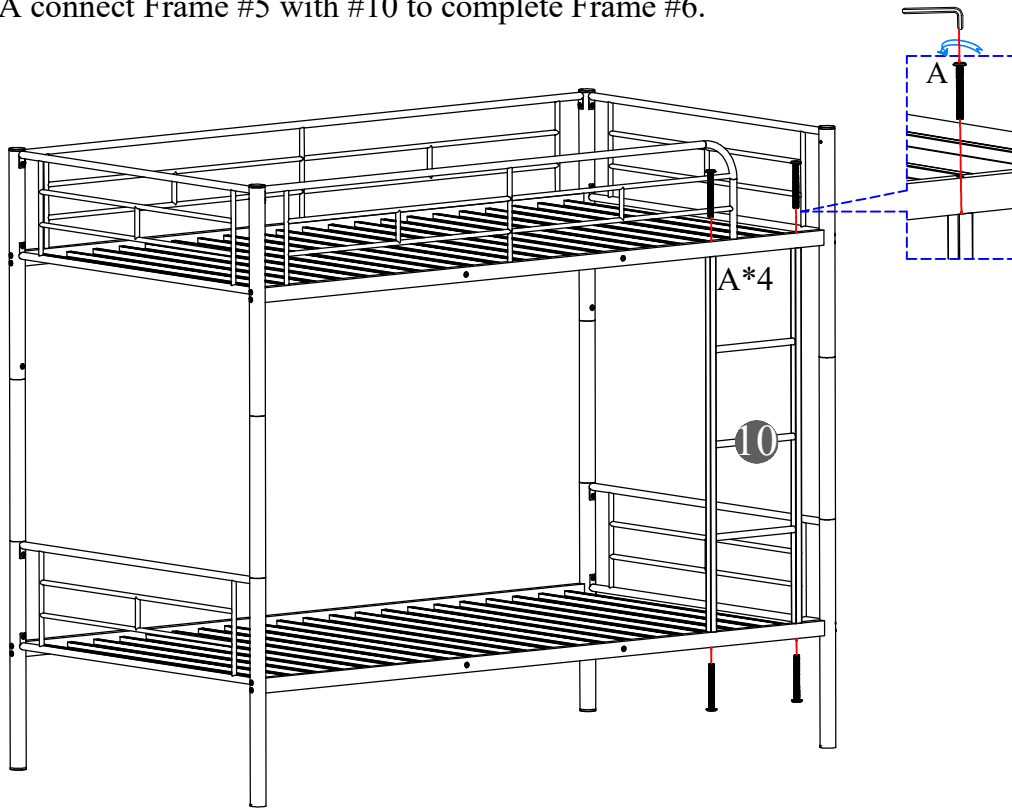
STEP 6 : Following below illustration Assembly Frame #6.  
 Using hardware #A connect Frame #5 with #10 to complete Frame #6.





(A)	4PCS
	1/4*60
(D)	1PC
	4*59

NOTE: In this step, DO NOT tighten any bolt until you connect all part together.

STEP 7 : Following below illustration Assembly Frame #7.  
 Using hardware #E connect Frame #6 with Wall to complete .

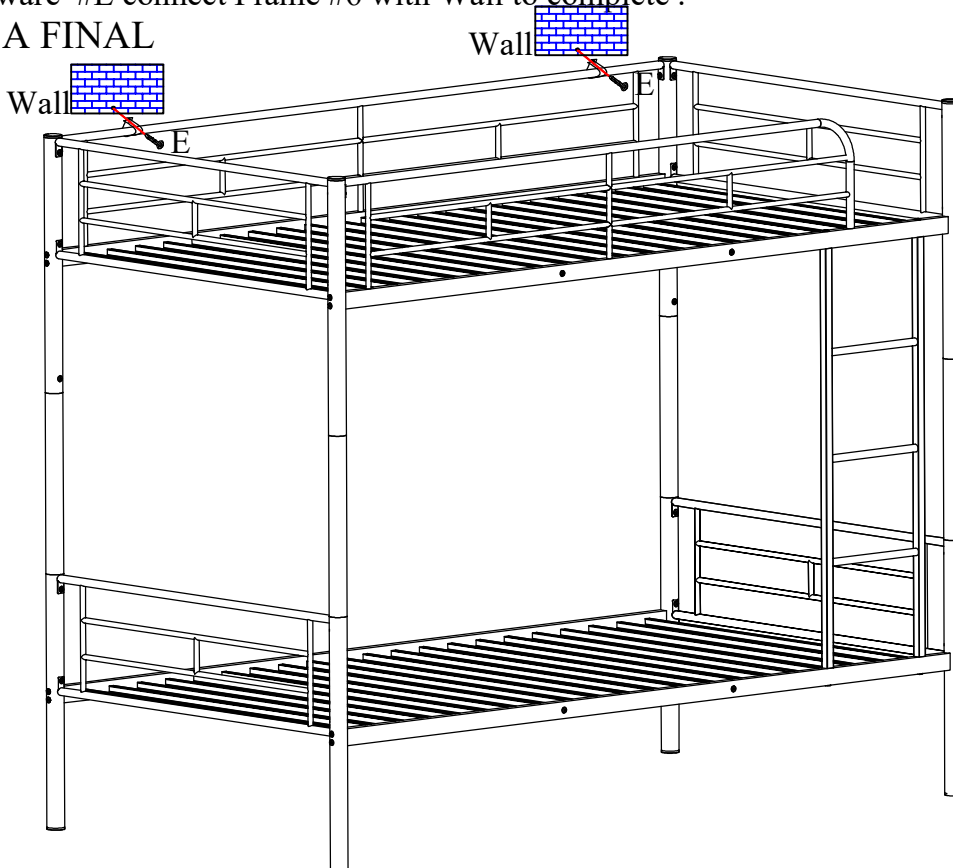
OPTION A FINAL

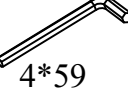

(E)	2 SET
	
(D)	1PC
	4*59

NOTE: Tighten all step before using. Thank you.

TWIN OVER TWIN BUNK BED  
ASSEMBLY INSTRUCTIONS  
SKU MF286424

OPTION B STEP 8-12

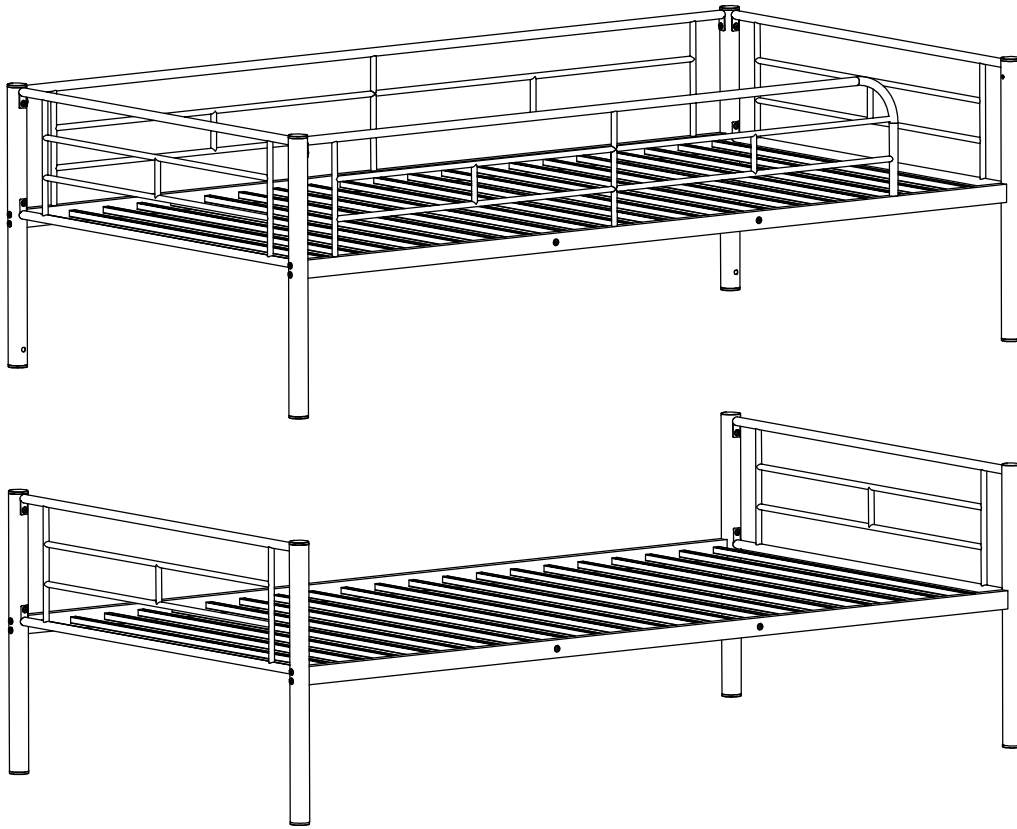

STEP 8 : Following below illustration Assembly Frame #8.  
Using allen key D open #10 to complete.

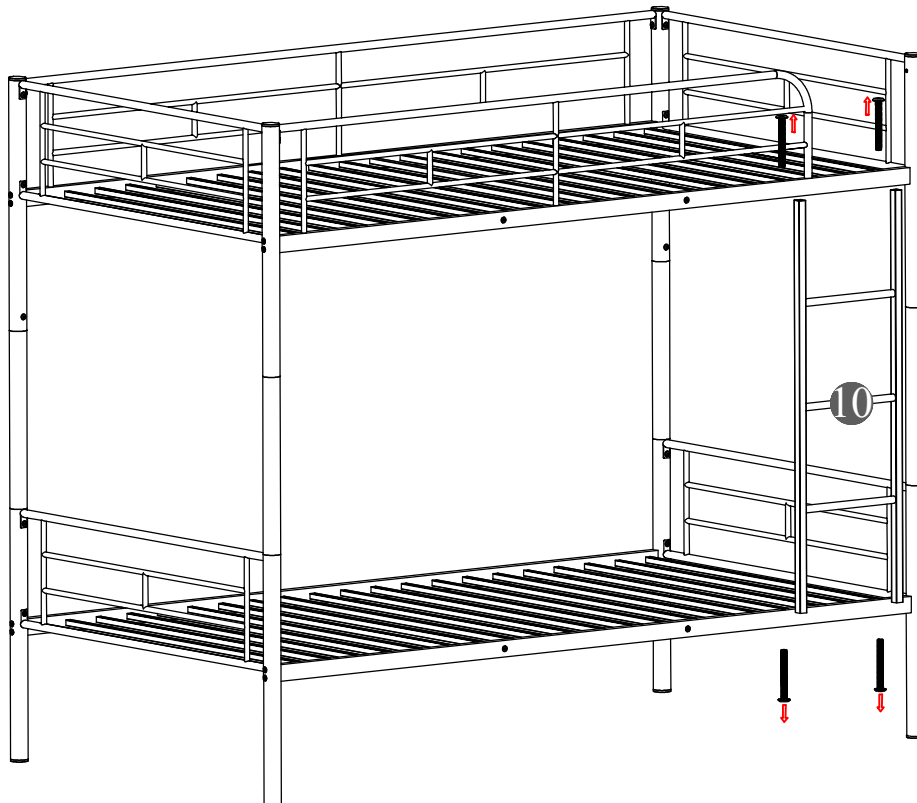

NOTE: In this step, DO NOT tighten any bolt until you connect all part together.

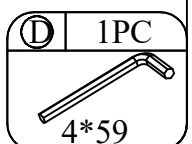

TWIN OVER TWIN BUNK BED  
ASSEMBLY INSTRUCTIONS  
SKU MF286424

STEP 9 : Following below illustration Assembly Frame #9.  
Using allen key D open hardware B to complete.

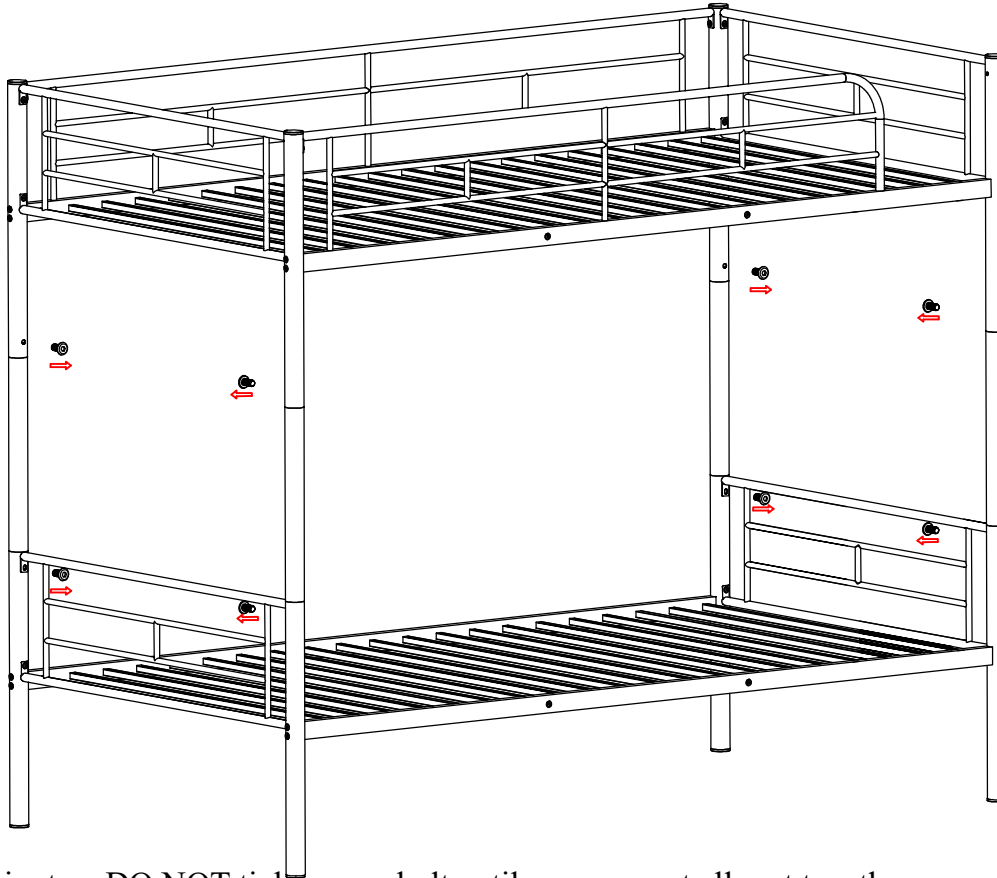

NOTE: In this step, DO NOT tighten any bolt until you connect all part together.

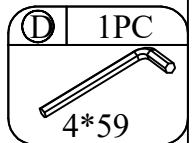

STEP 10 : Following below illustration Assembly Frame #10.

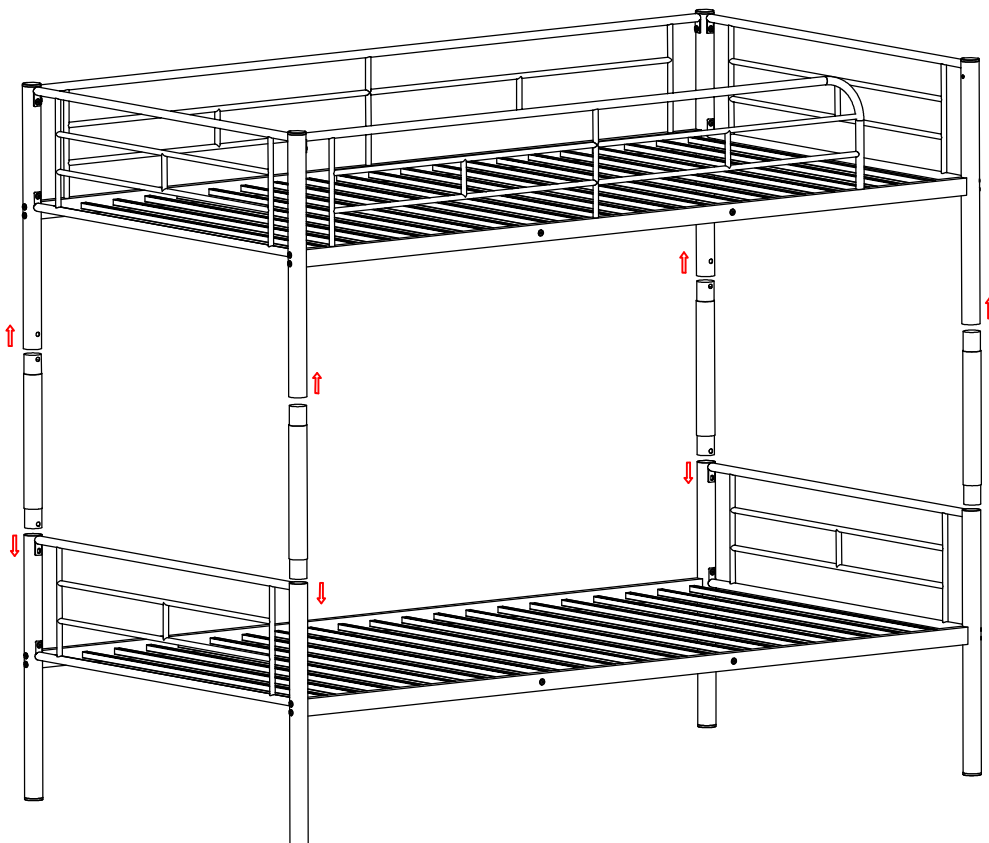



NOTE: In this step, DO NOT tighten any bolt until you connect all part together.

TWIN OVER TWIN BUNK BED  
 ASSEMBLY INSTRUCTIONS  
 SKU MF286424

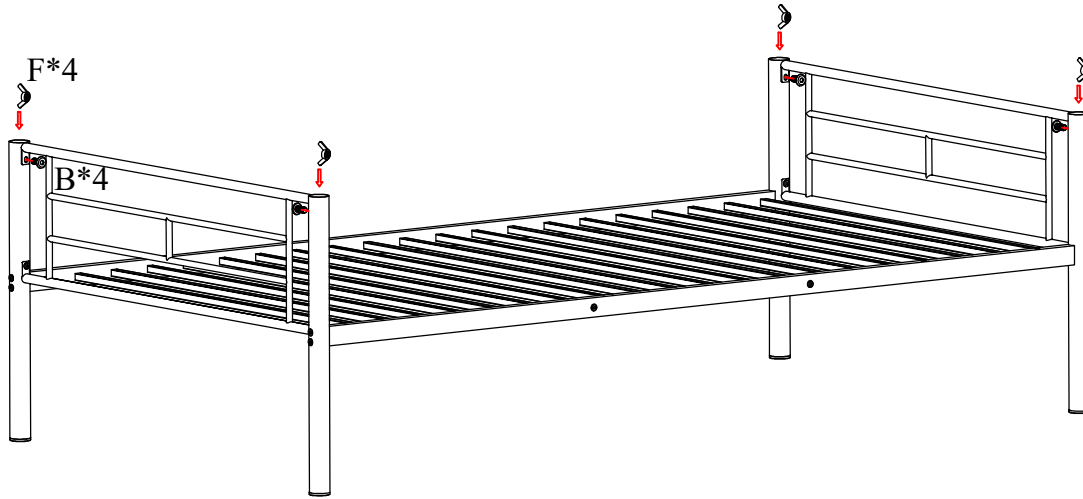
STEP 11 : Following below illustration Assembly Frame #11.  
 Using hardware #B, #F connect with Frame #10 to complete.



(B)	4PCS
	
1/4*15	
(D)	1PC
	
4*59	
(F)	4PCS
	

NOTE: In this step, DO NOT tighten any bolt until you connect all part together.

STEP 12 : Following below illustration Assembly Frame #12.  
 Using hardware #C connect with Frame #11, #10 to complete.

OPTION B FINAL

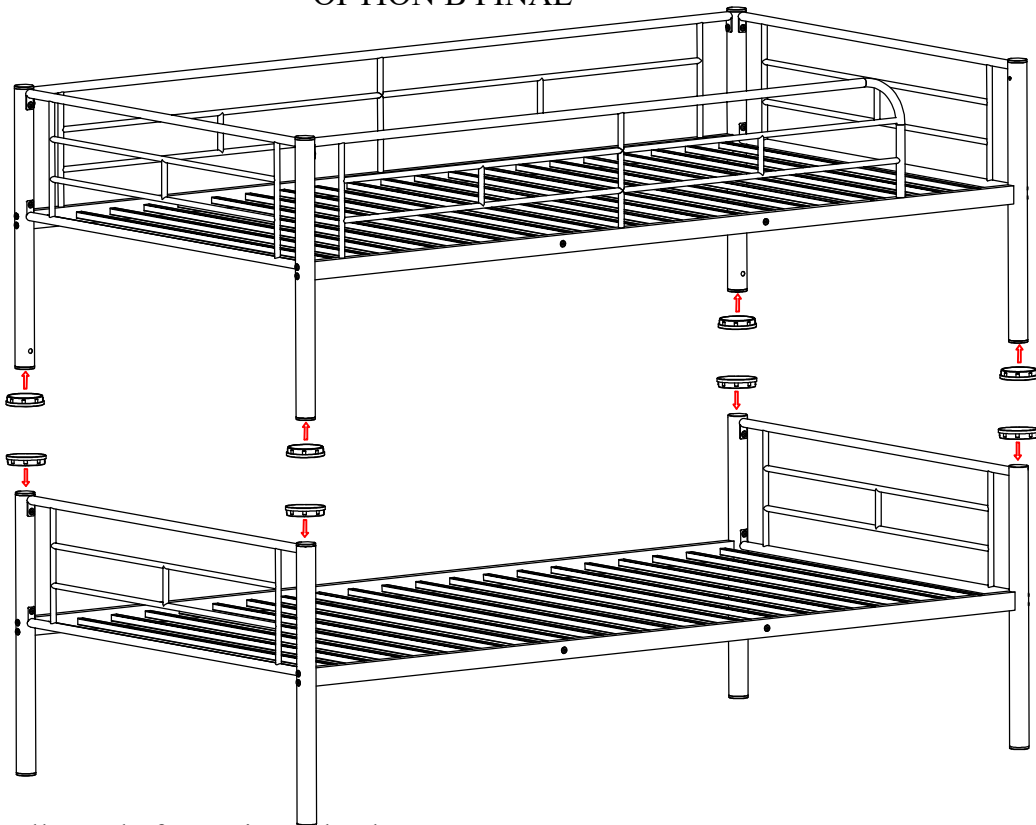

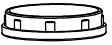
(C)	8PCS
	
Ø42	

NOTE: Tighten all step before using. Thank you.