

ASSEMBLY INSTRUCTION

RIGHT & LEFT CORNER SEAT

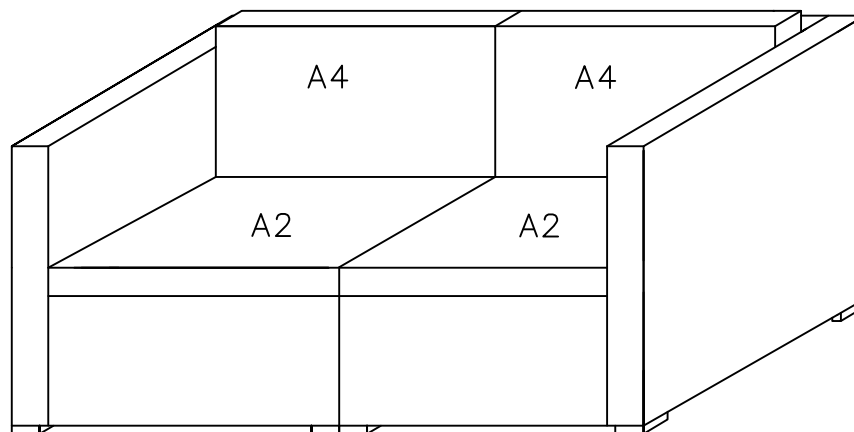

Thank you for choosing Beefurni!

Our goal is to provide high quality outdoor furniture with outstanding customer service at an affordable price.
Please let us know how we are doing!

Problems?

Please kindly contact us 24/7 via email support@beefurni.com
As a valued customer, your satisfaction is our #1 priority!

Other products?

Please kindly find our more products at website www.beefurni.com

PART LIST

E1x1

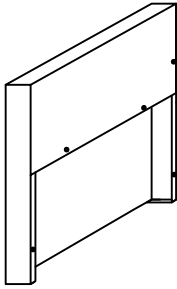

Left corner arm frame

E2x1

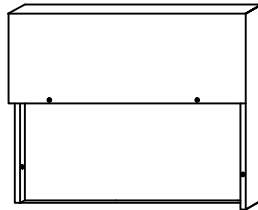

Left corner back frame

E3x1

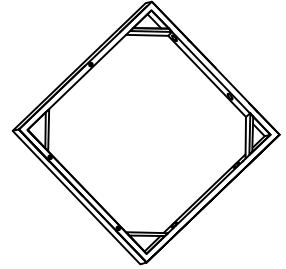

Left corner seat frame

E4x1

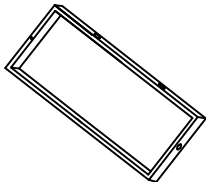

Left corner front frame

F1x1

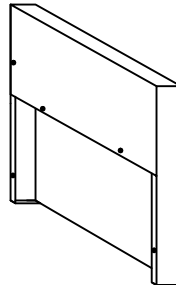

Right corner arm frame

F2x1

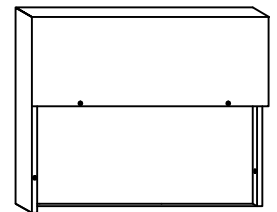

Right corner back frame

F3x1

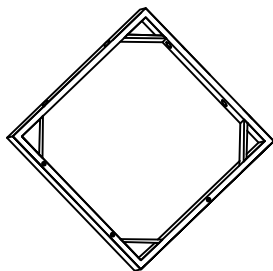

Right corner seat frame

F4x1

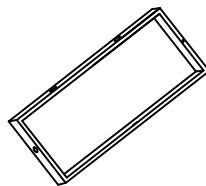

Right corner front frame

B3x2

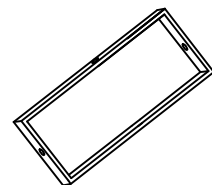

Side frame

PART LIST

A2x2

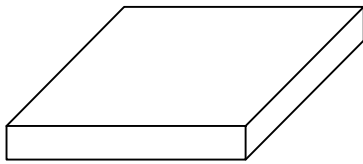

Seat Cushion

A4x2

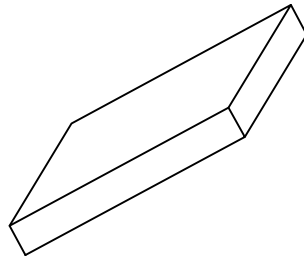

Back Cushion

Lx6

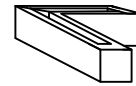

Feet L shape

Ix2

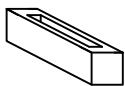

Feet I shape

Nx40



Bolt M6x30

Ox24



Washer 15x6x1

Px1

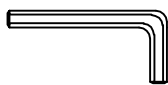

Allen key

LEFT CORNER CHAIR

Step 1

Connect E1 with E2 by bolt N, washer O and allen key P.

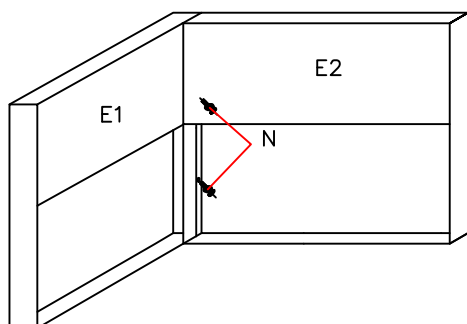

Step 2

Connect parts from step 1 with E3 by bolt N, washer O and allen key P.

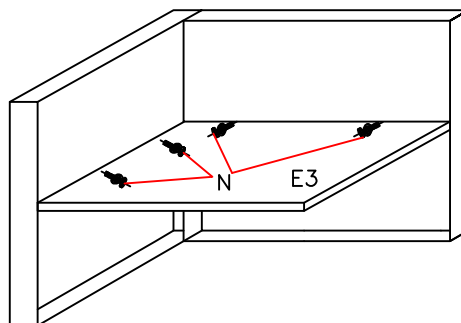

Step 3

Connect parts from step 2 with E4 and B3 by bolt N, washer O and allen key P.

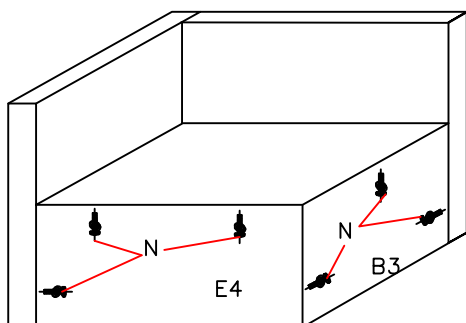

Step 4

Connect parts from step 3 with 3 feet L shape and 1 feet I shape by bolt N and allen key P.

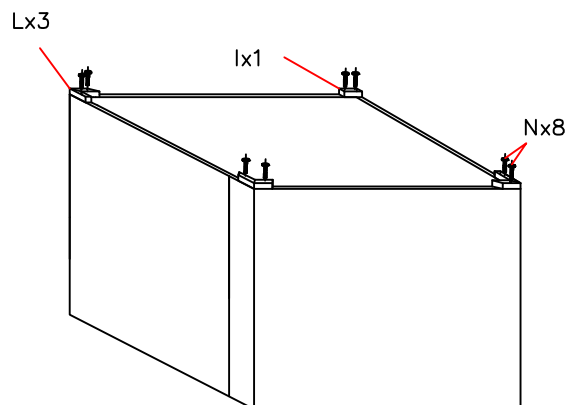

RIGHT CORNER CHAIR

Step 1

Connect F1 with F2 by bolt N, washer O and allen key P.

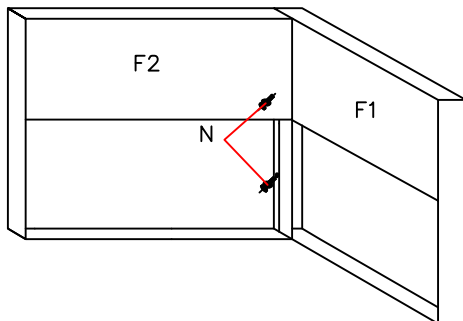

Step 2

Connect parts from step 1 with F3 by bolt N, washer O and allen key P.

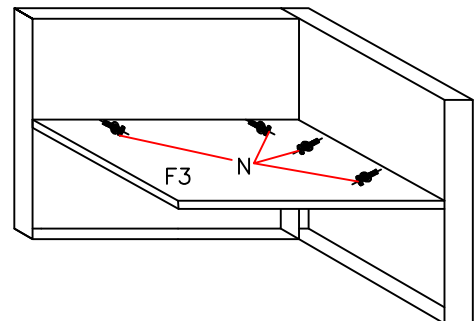

Step 3

Connect parts from step 2 with F4 and B3 by bolt N, washer O and allen key P.

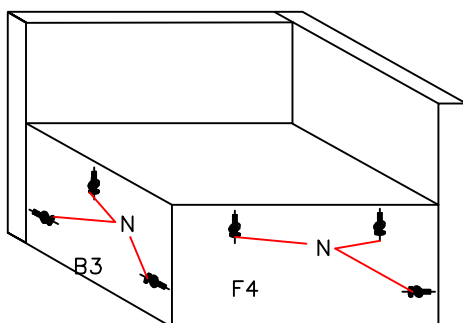

Step 4

Connect parts from step 3 with 3 feet L shape and 1 feet I shape by bolt N and allen key P.

