







<p>A</p>  <p>26PCS</p>	<p>B 8*40</p>  <p>24PCS</p>	<p>C 6*20</p>  <p>8PCS</p>	<p>D 3.5*14</p>  <p>28PCS</p>	<p>E</p>  <p>2PCS</p>	<p>F</p>  <p>8PCS</p>	<p>G</p>  <p>34PCS</p>	<p>H</p>  <p>4PCS</p>
--	---	--	--	---	---	--	---



Remove nuts during installation to facilitate installation (C).
After component (D) has been installed,
reattach the removed nuts to their original position.

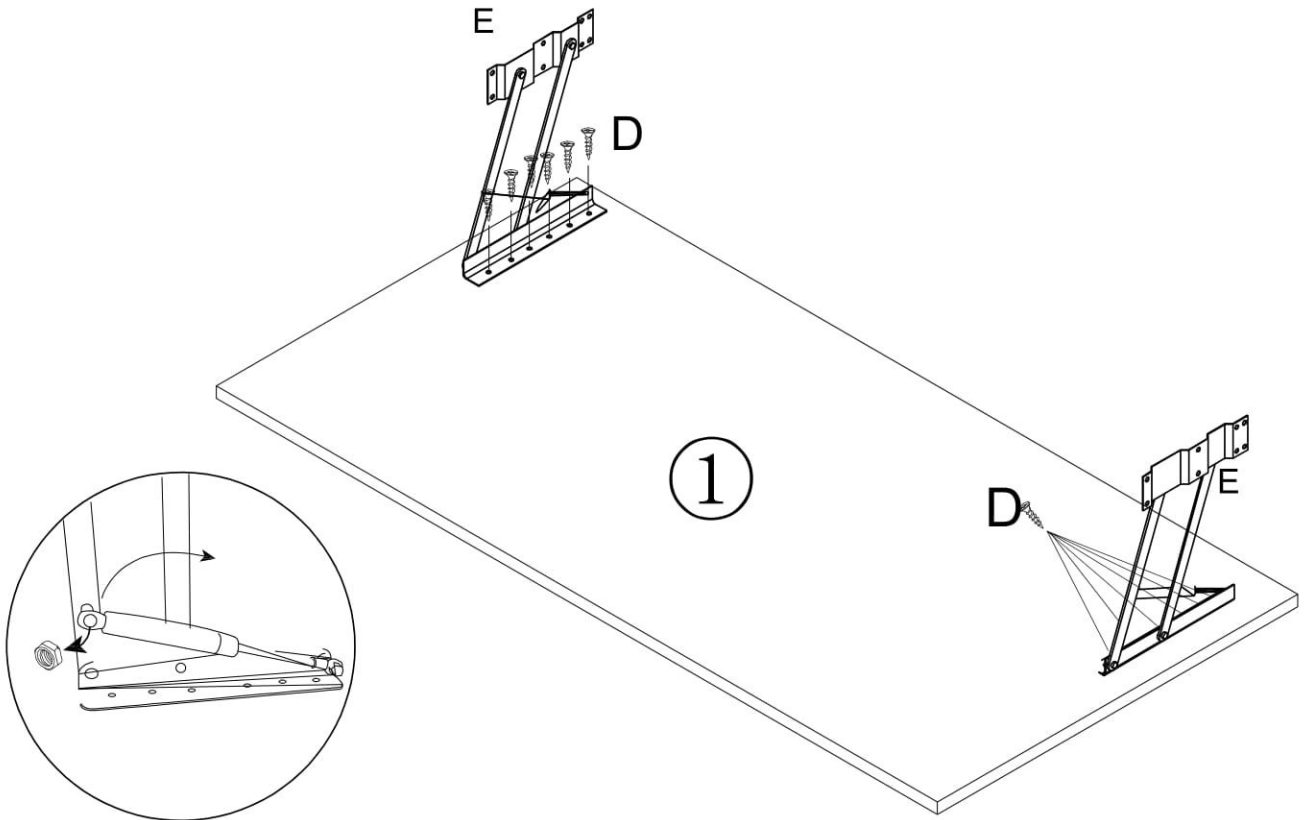