

6-Person Dining Table

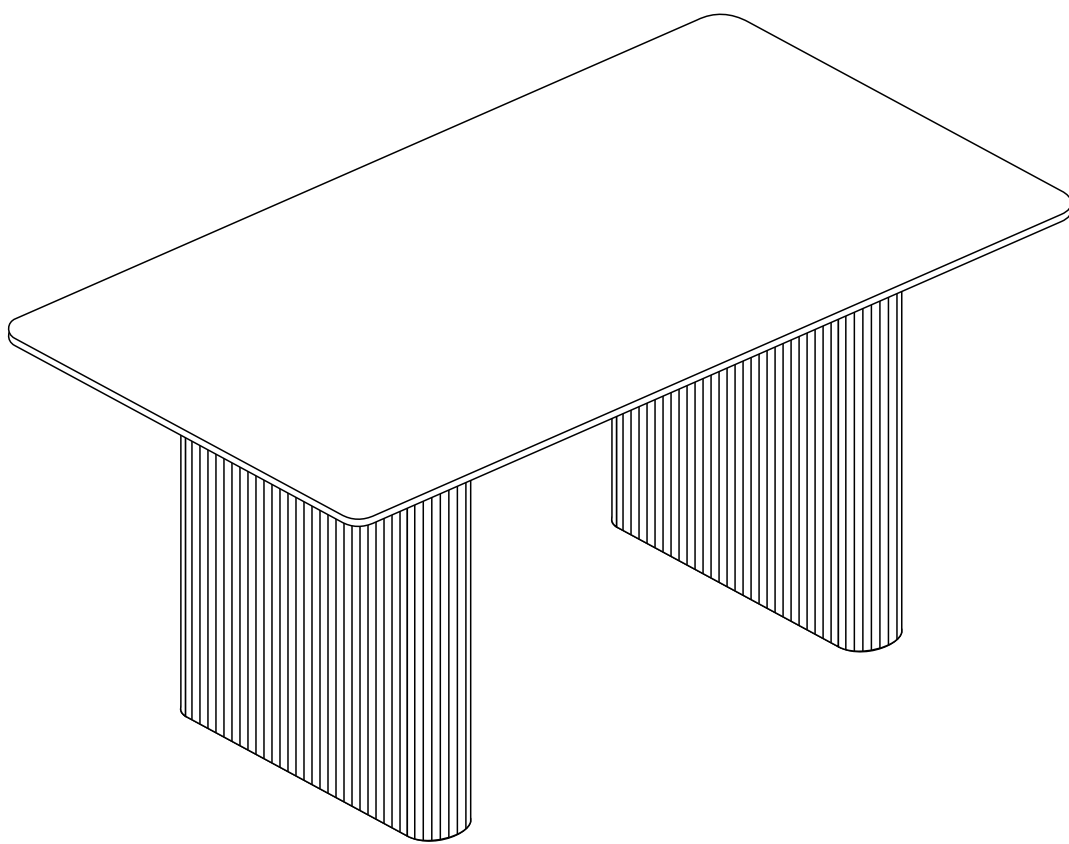

ASSEMBLY INSTRUCTIONS



60 min. assembly

2 person

*The estimated assembly time may vary depending on the individual.

Hey, there

Now is assembly time!

Deeeeep breathe.... and again....
Tools ready,
Easy peasy!

Estimated



60 min. assembly
2 person

Tools Required

- Allen Wrench (included)
- Straight screwdriver (included)

important: *Cautious when you use power tools*

Thank you for purchasing this LuxenHome product. This product has been manufactured with the highest standards of safety and quality.

PLEASE READ ALL INSTRUCTIONS CAREFULLY BEFORE ASSEMBLY.

Un pack all parts from the packaging inside the carton to ensure there are no missing or damaged parts. Lay out all the parts on a clean, flat, and soft surface to prevent scratches. Refer to the steps provided as assembling guide.

Do not attempt to assemble or use the product if any parts are missing or damaged.

REMINDERS

SAFE USAGE IS KEY

Your well-being is our top priority when you use our product. Please prioritize your safety by diligently following the assembly guidelines and inspecting the product carefully both when it arrives and before each use.

Please be aware that LuxenHome and Winsome House, Inc. cannot be held liable for any injuries or fatalities that occur due to not adhering to the provided instructions or misuse of the product.

DO NOT MODIFY

Our products undergo rigorous testing to ensure they meet established safety standards before being released for sale. Altering the product in any way can lead to serious safety concerns, for which LuxenHome cannot assume responsibility.

What's in the box

Parts

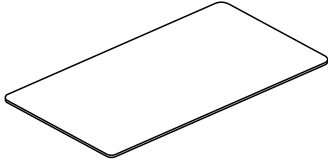

1 X 1

Top panel

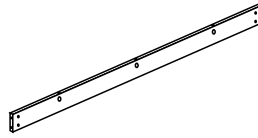

2 X 2

Top support bar

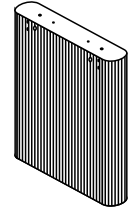

3 X 2

Table leg

Hardware & Accessory



A X 10+2

M6 x 36mm



B X 10+2

M15 x 9mm



C X 4

M6 x 30mm

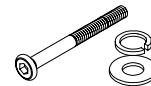

D X 8

M6 x 95mm



E X 8

M6 x 15mm

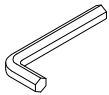

F X 1

Allen key



G X 1

Straight screwdriver



H X 4

Foot nail

Assembly

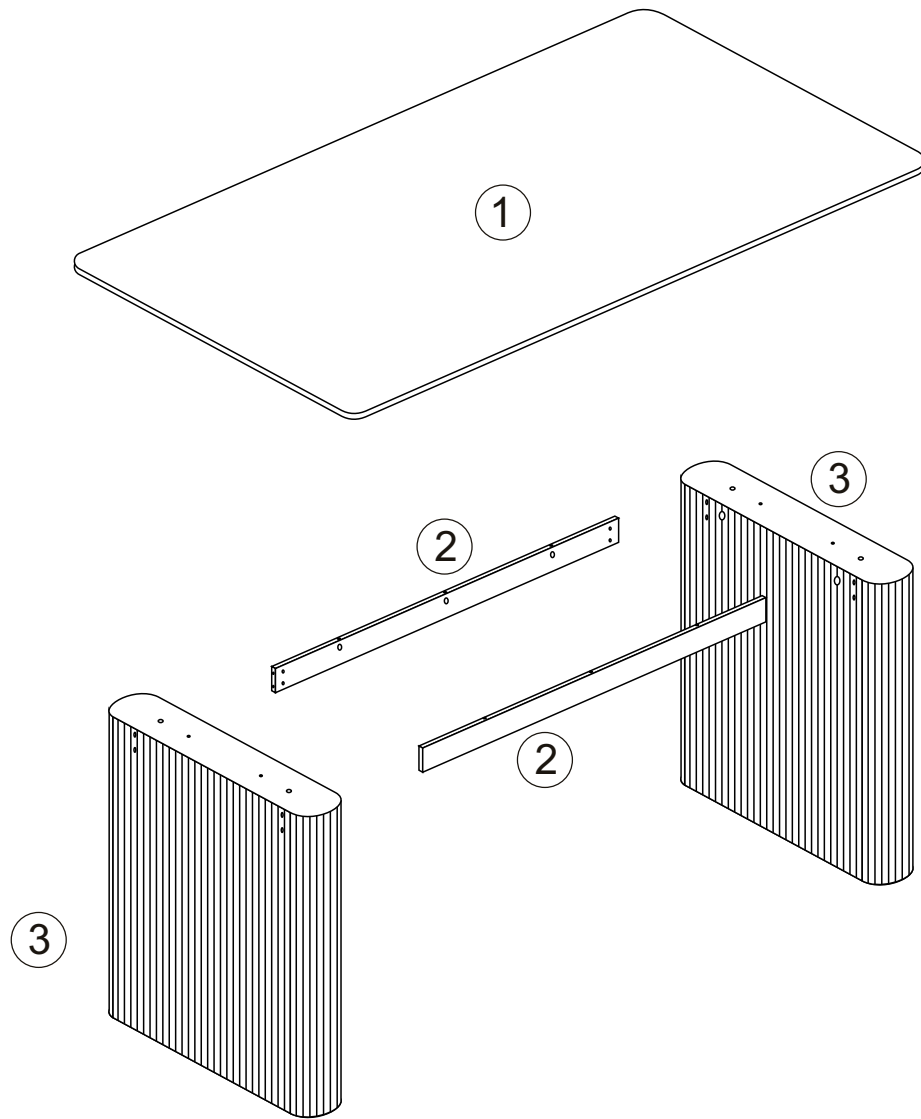

Step 1

Insert quickfit screws (A) into part 1, as shown.

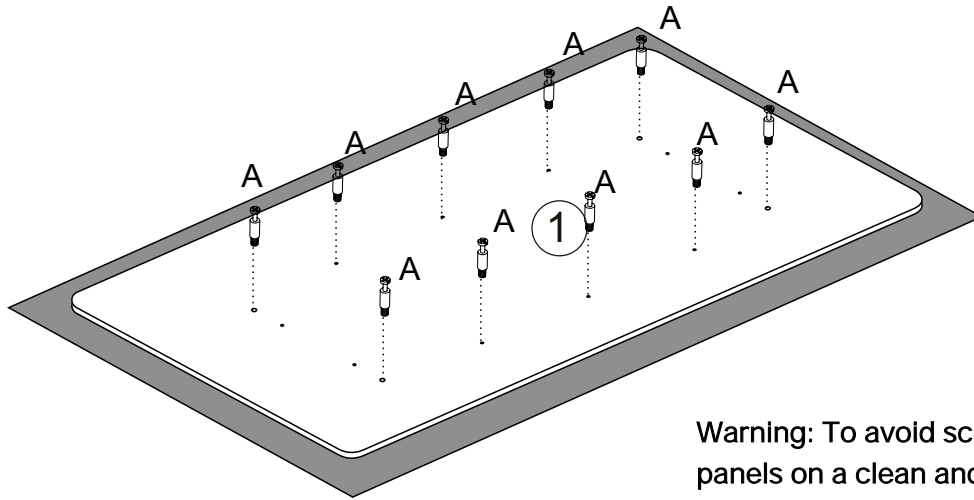
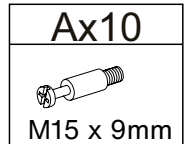

Warning: To avoid scratches, place the panels on a clean and soft surface.

Step 2

Insert cam locks (B) into parts 2, as shown.

Fit parts 2 to part 1.

Turn cam locks clockwise to tighten.

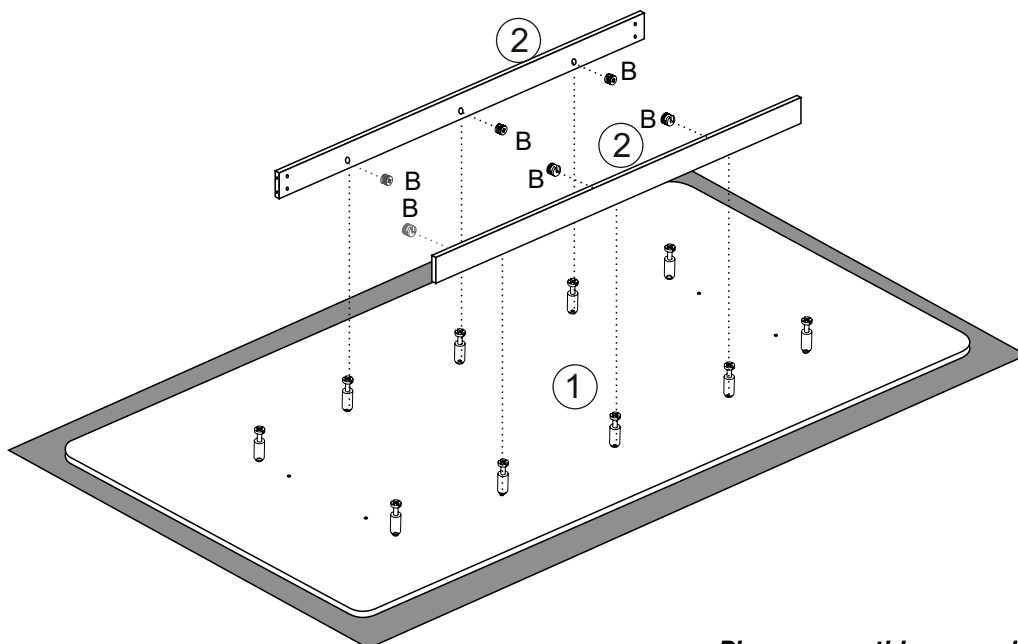
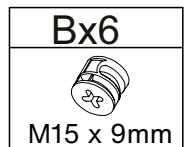

Step 3



Insert cam locks (B) to parts 3, as shown.

Insert wooden dowels (C) into part 1, as shown.

Fit parts 3 to part 1.

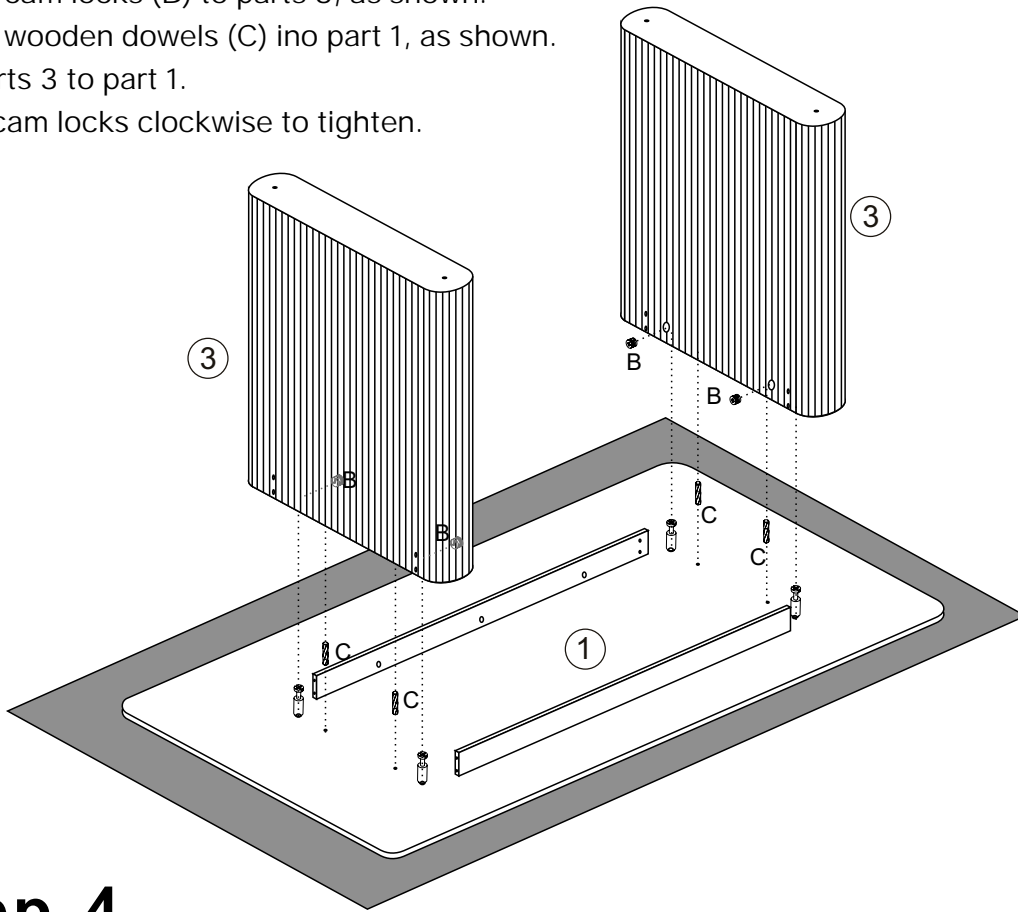
Turn cam locks clockwise to tighten.



Bx4
 M15 x 9mm
Cx4
 M5.8 x 30mm





Step 4

Insert nuts (E) into parts 2, as shown.

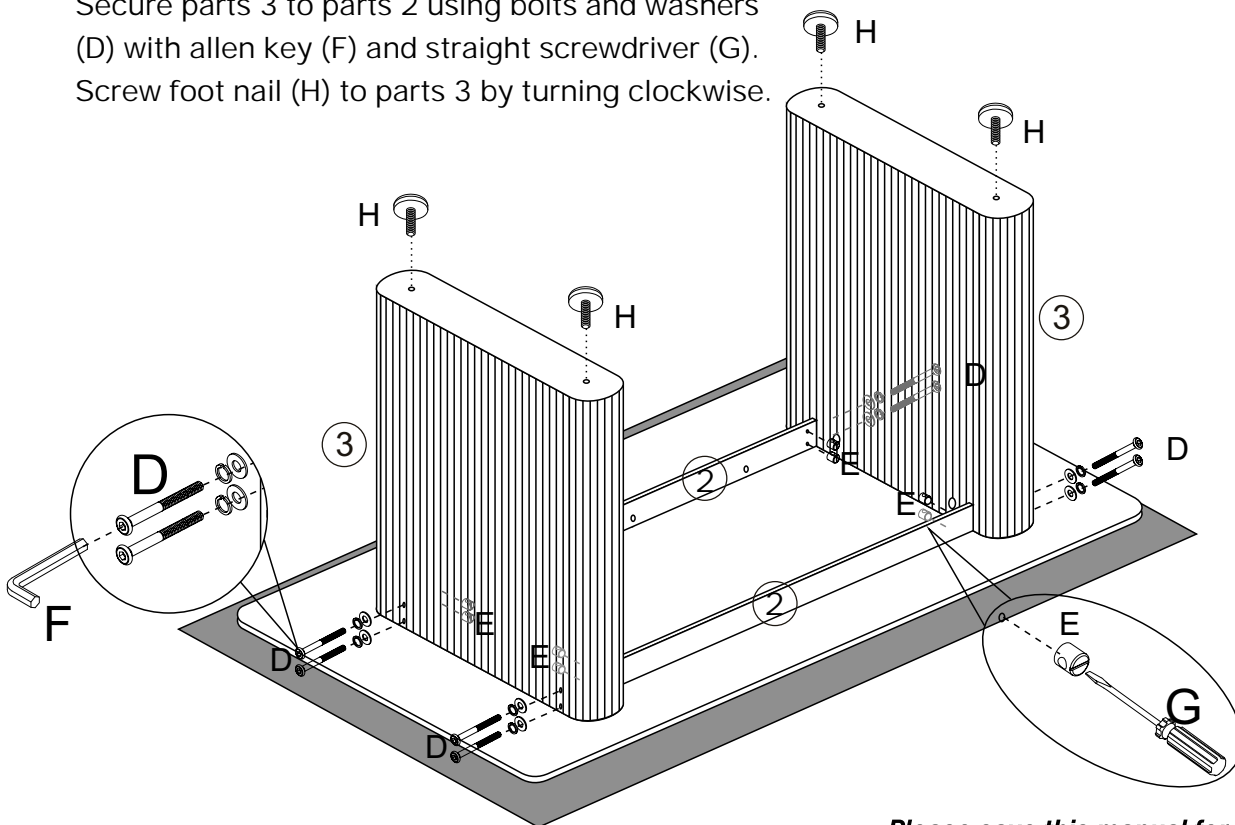
Secure parts 3 to parts 2 using bolts and washers (D) with allen key (F) and straight screwdriver (G).

Screw foot nail (H) to parts 3 by turning clockwise.



Dx8
 M6 x 95mm
Ex8
 M6 x 15mm
Fx1

Gx1

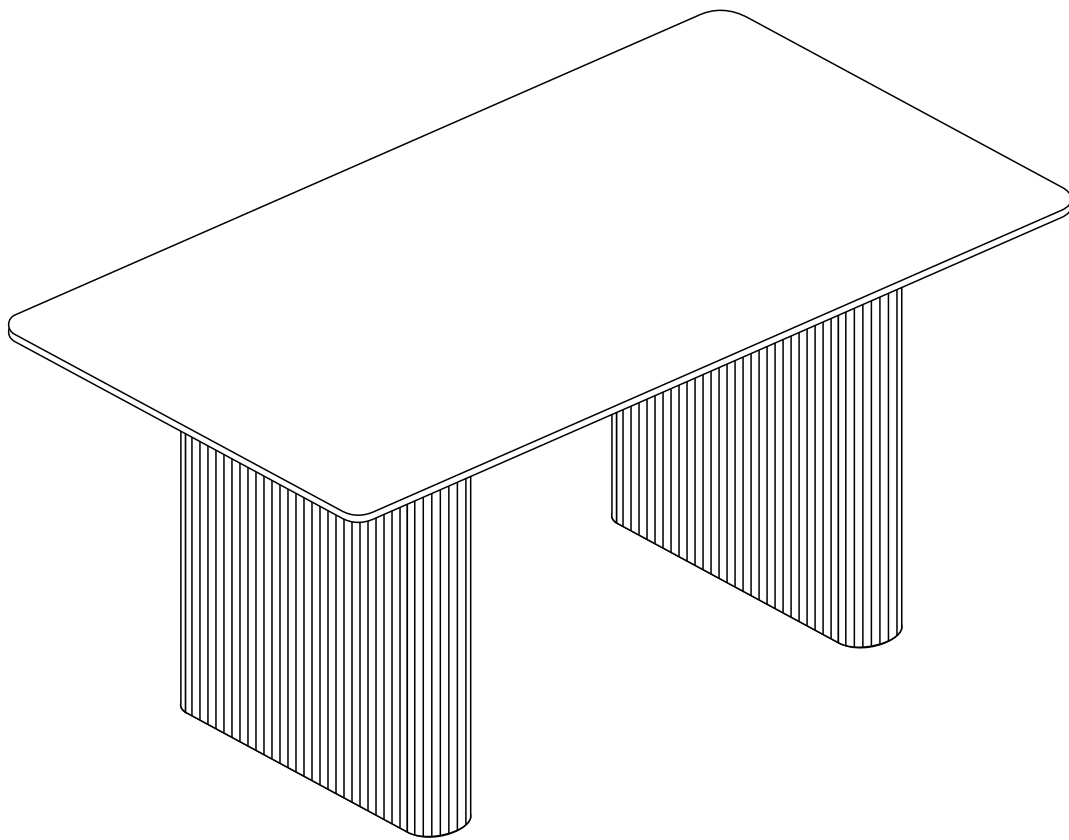
Hx4

VOILA!
Now enjoy.



Warning

DO NOT sit or stand on the Table as this may damage the product and cause serious bodily injury.

Something not right?

We are always here to help.

We make mistakes like every human does.

Though we always strive to provide the best possible products at competitive prices and the best service in the industry, it's not possible to completely eliminate mistakes. If you experience any dissatisfaction, feel free to contact us immediately. Our in-house customer care team will respond ASAP.

Things to do to expedite the process

- Have your order# ready
- Take photos/videos to help us better identify the issues
- DO NOT throw away the packaging