

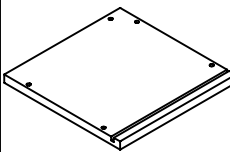

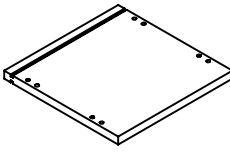

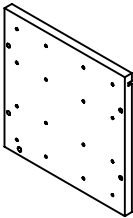

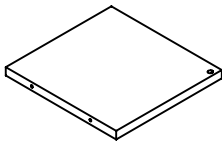

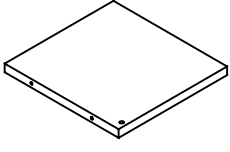
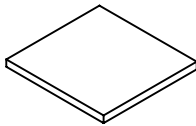
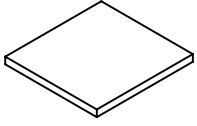
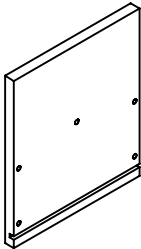
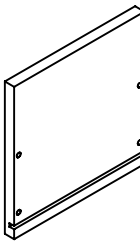
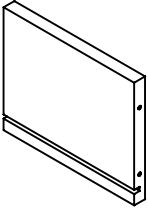
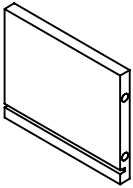
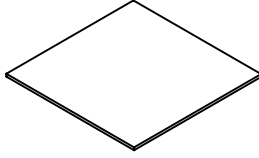
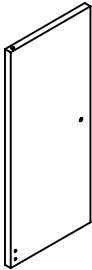
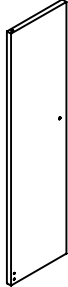
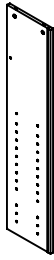

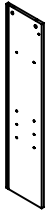
<p>①</p>  <p>x 1</p>	<p>②</p>  <p>x1</p>	<p>③</p>  <p>x1</p>	<p>④</p>  <p>x1</p>	<p>⑤</p>  <p>x1</p>
<p>⑥ 172*181mm</p>  <p>x4</p>	<p>⑦ 172*165mm</p>  <p>x1</p>	<p>⑧</p>  <p>x1</p>	<p>⑨</p>  <p>x1</p>	<p>⑩</p>  <p>x2</p>
<p>⑪</p>  <p>x1</p>	<p>⑫</p>  <p>x1</p>	<p>⑬</p>  <p>x1</p>	<p>⑭</p>  <p>x1</p>	<p>⑮</p>  <p>x1</p>
<p>⑯</p>  <p>x1</p>	<p>⑰</p>  <p>x1</p>	<p>⑱</p>  <p>x1</p>	<p>⑲</p>  <p>x2</p>	<p>A</p>  <p>M6x35 x12</p>
<p>B</p>  <p>Ø12 x12</p>	<p>C</p>  <p>M4x30 x20</p>	<p>D</p>  <p>M4x12 x20</p>	<p>E</p>  <p>M5 x26</p>	<p>F</p>  <p>x3</p>
<p>G</p>  <p>M4x16 x3</p>	<p>H</p>  <p>x4</p>	<p>J</p>  <p>x2</p>	<p>Z</p>  <p>Ø15 x32</p>	

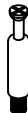
1

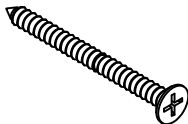
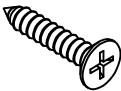

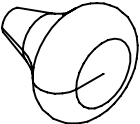
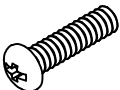
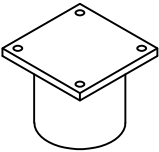
2

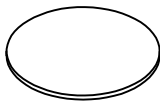
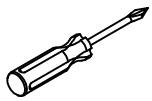
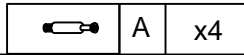
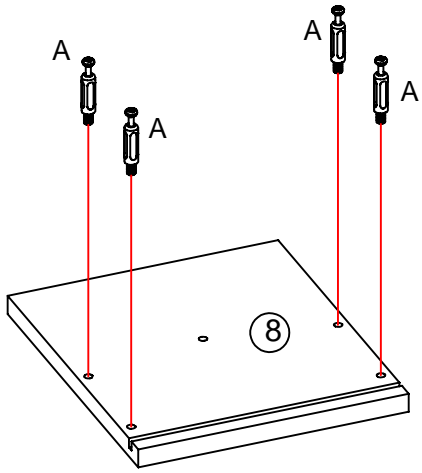
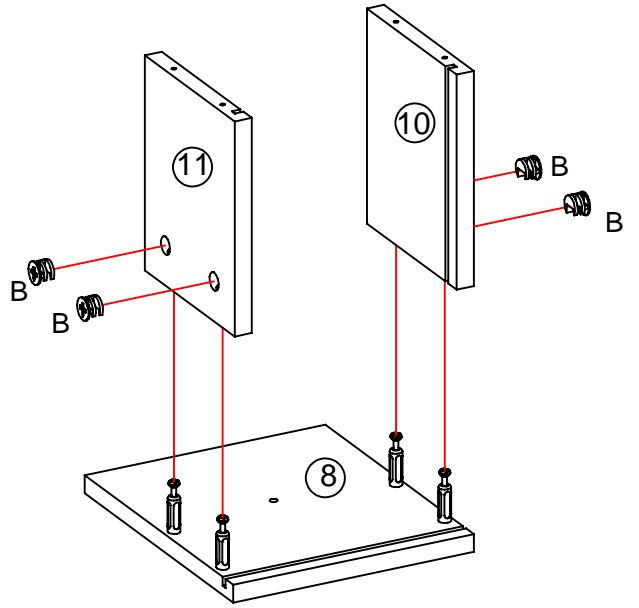

3

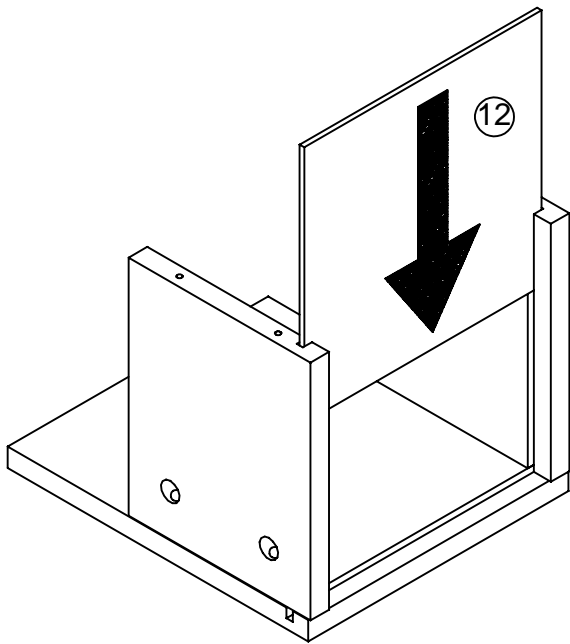

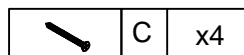
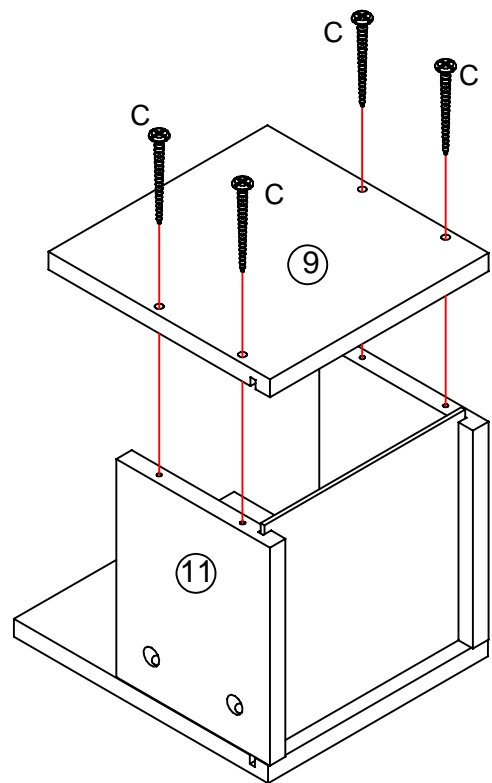

4



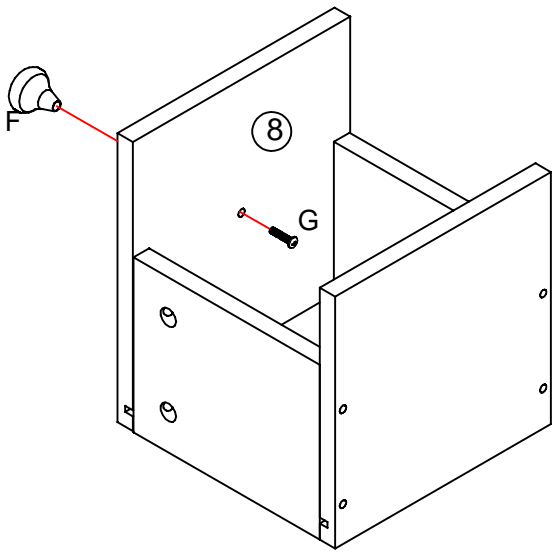

5

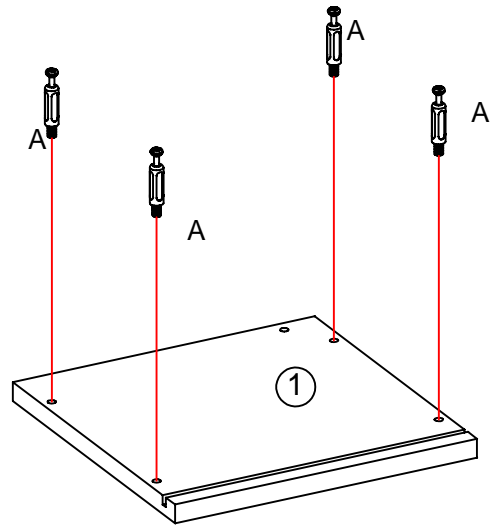

	F	x1
	G	x1

6



	A	x4
---	---	----

7

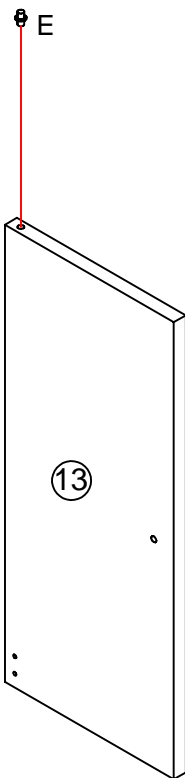

	E	x1
---	---	----

8

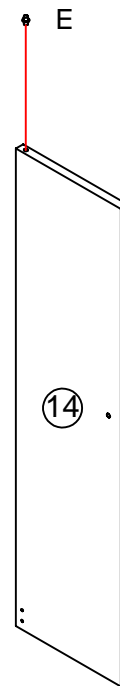

	E	x1
---	---	----

9

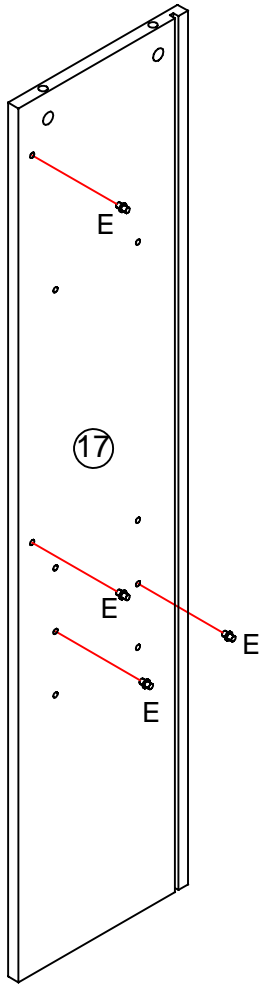

10

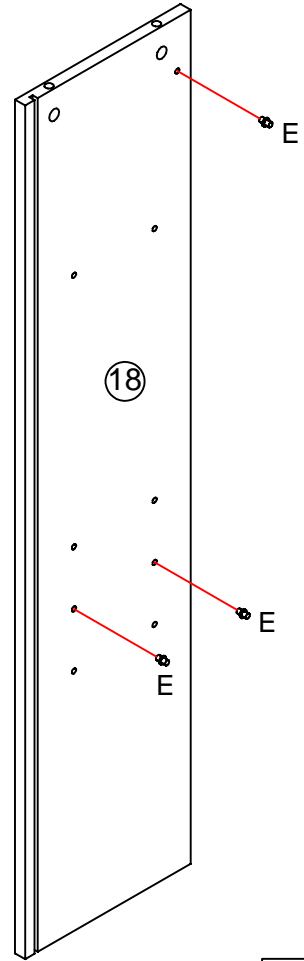

11

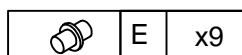
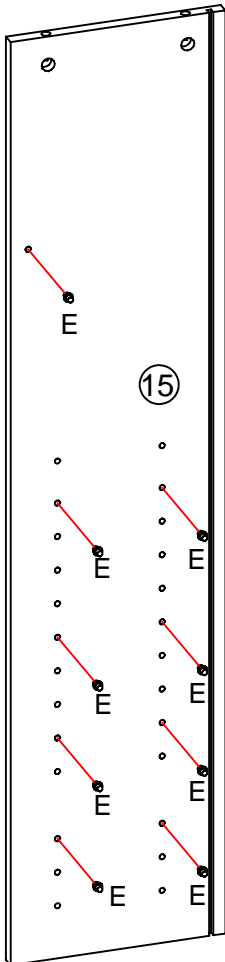

12

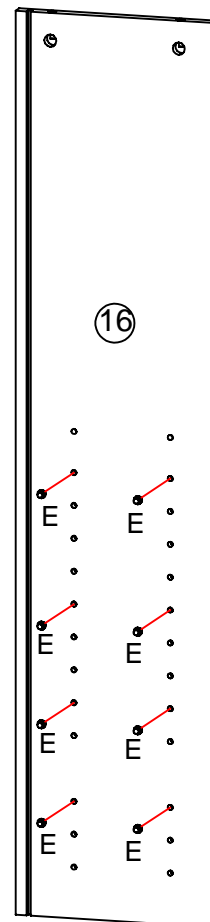

13

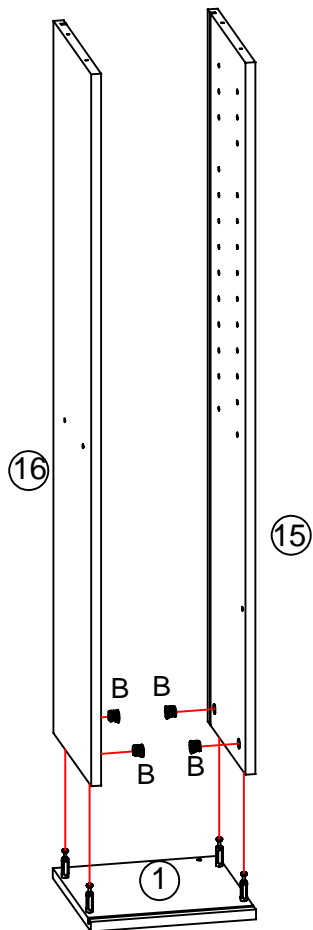

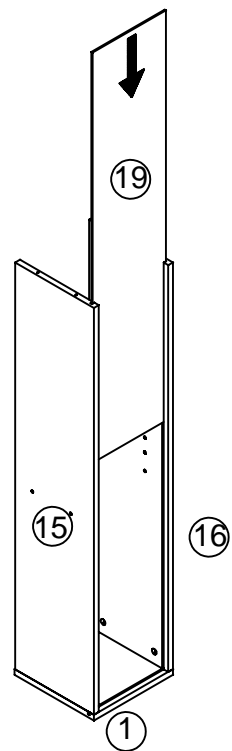

	B	x4
---	---	----

14

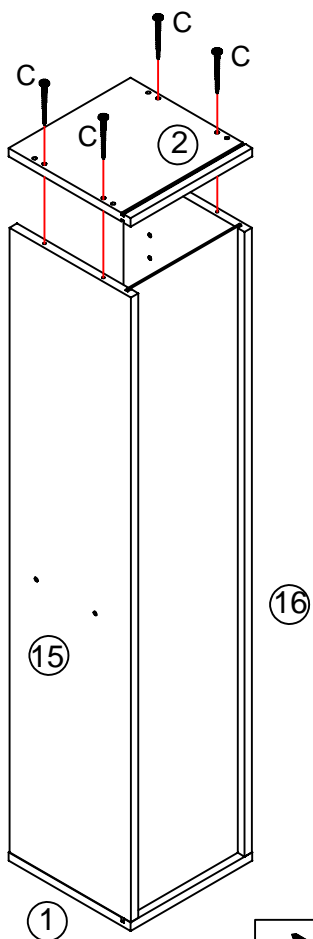

15



	C	x4
---	---	----

16

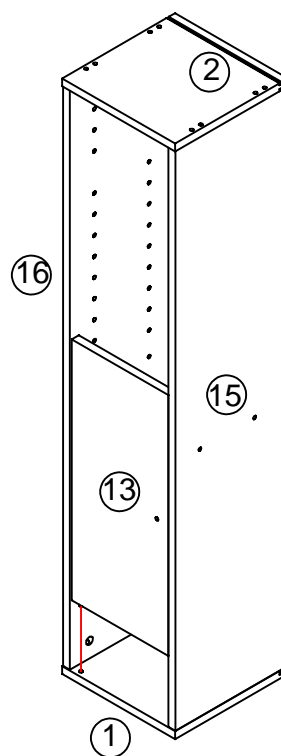

17

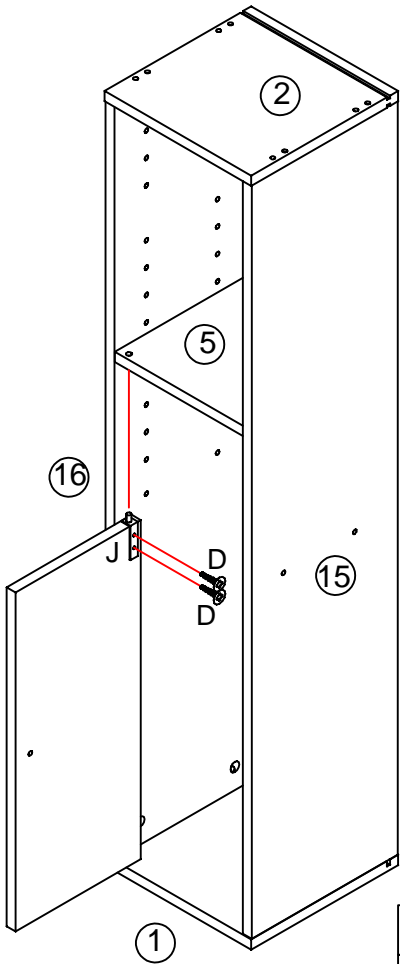

	J	x1
	D	x2

18

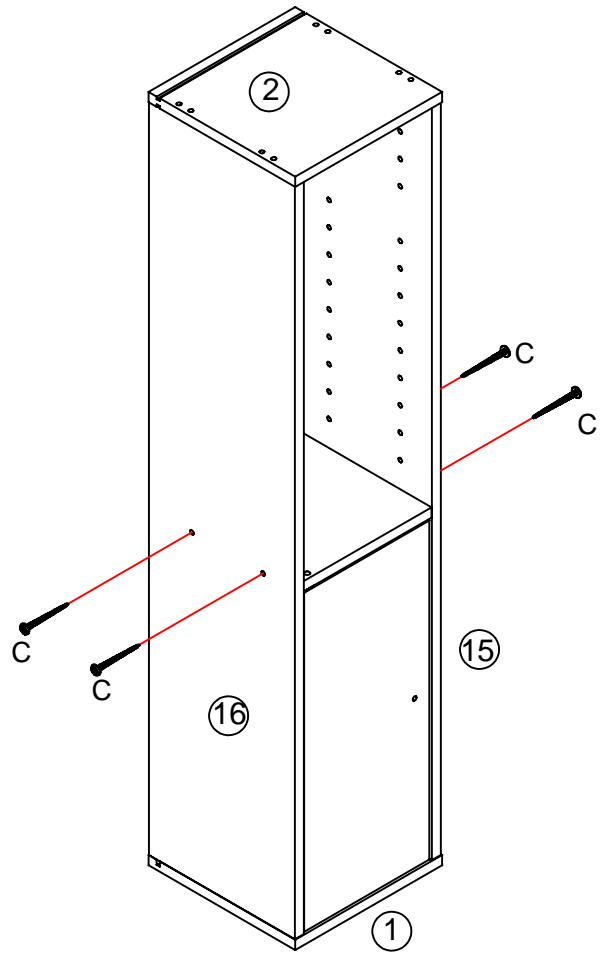

	C	x4
--	---	----

19

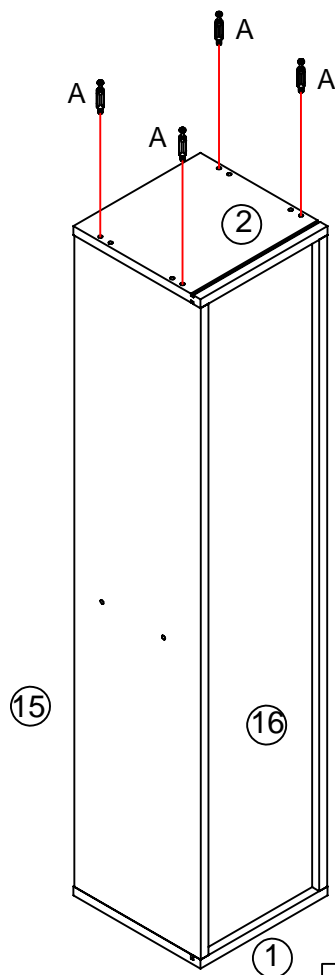

	A	x4
--	---	----

20

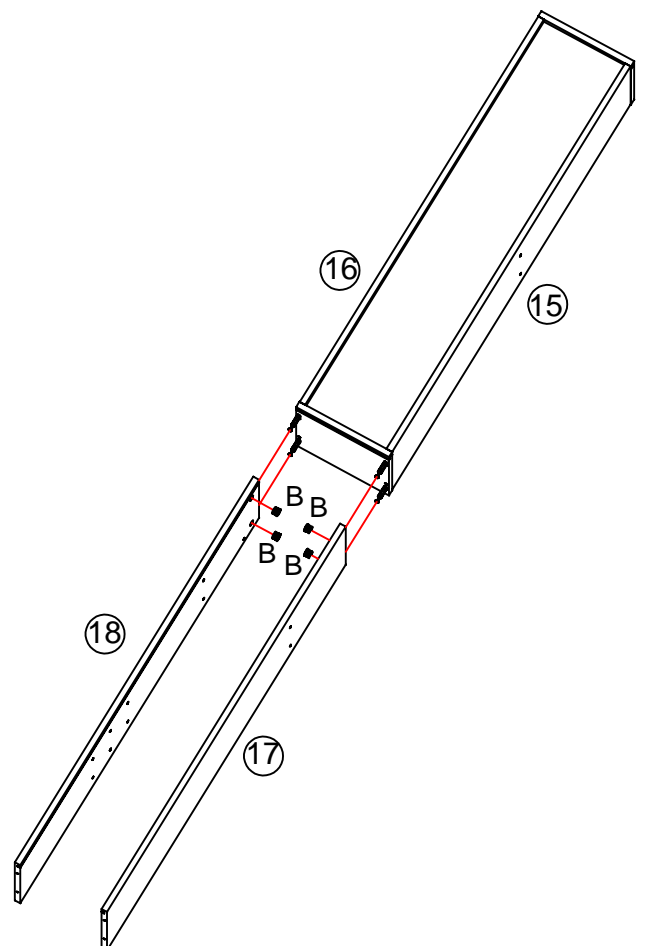

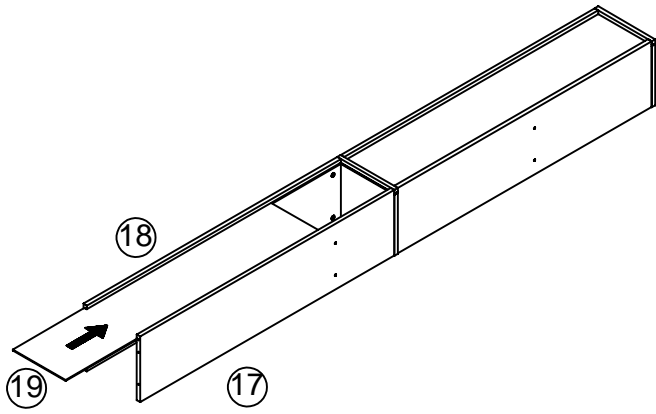

	B	x4
--	---	----

21



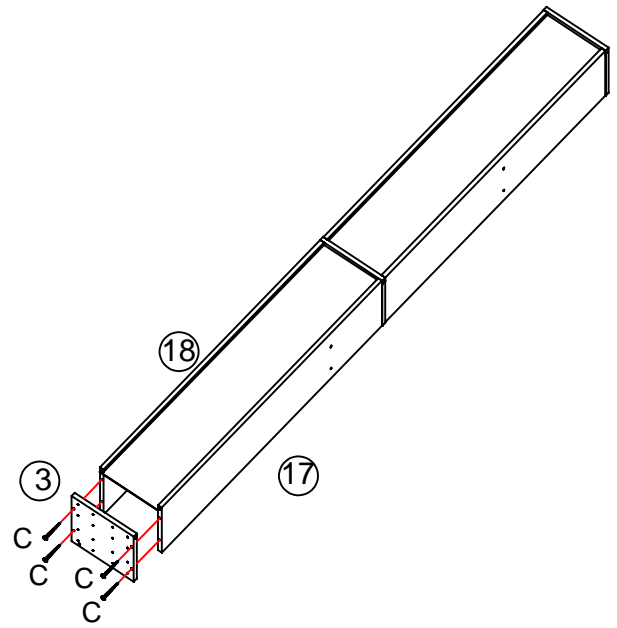

22

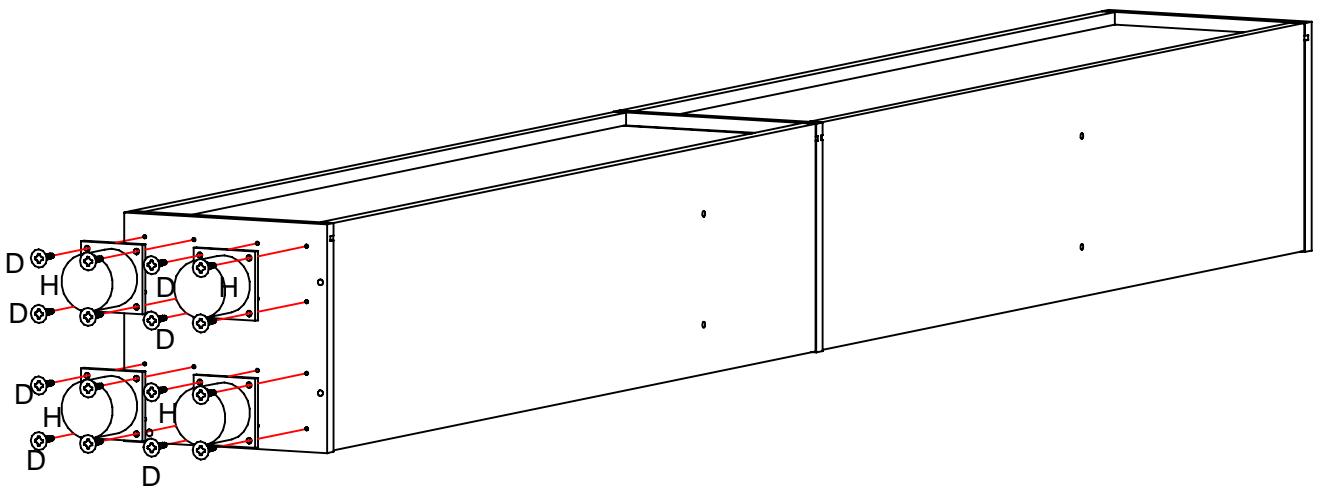

	C	x4
---	---	----

23





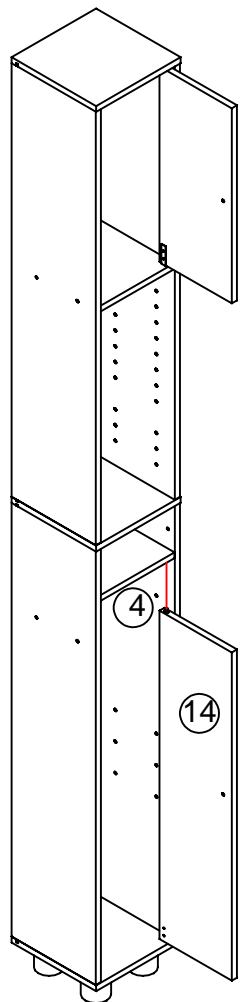

	H	x4
	D	x16

24

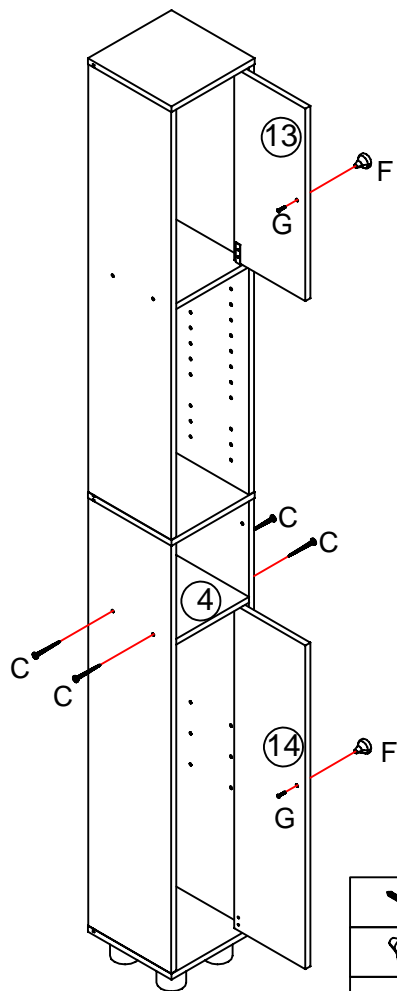



25

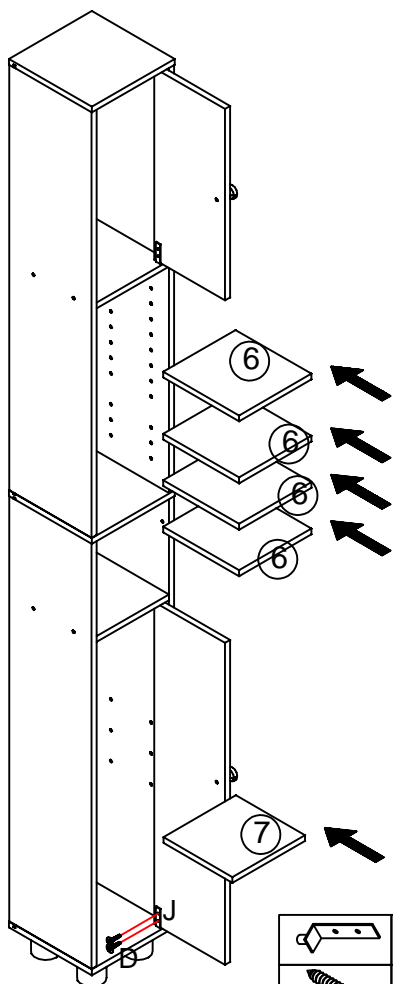

	C	x4
	F	x2
	G	x2

26



	J	x1
	D	x2

27

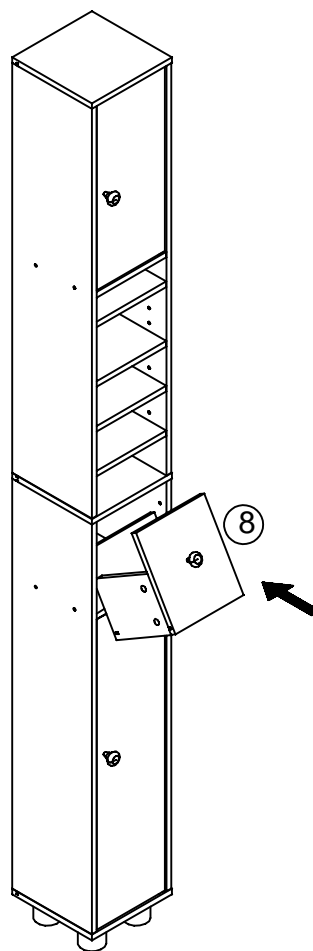

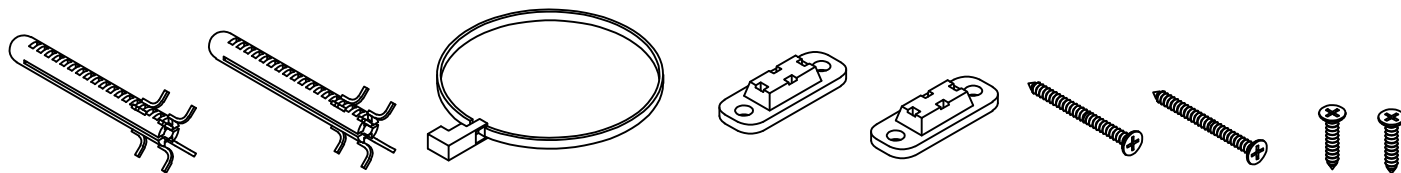

1

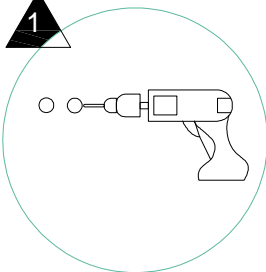

2

wall space

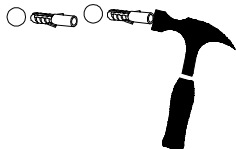

3

