

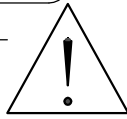

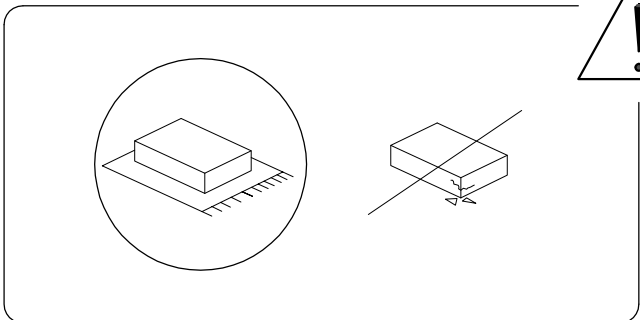

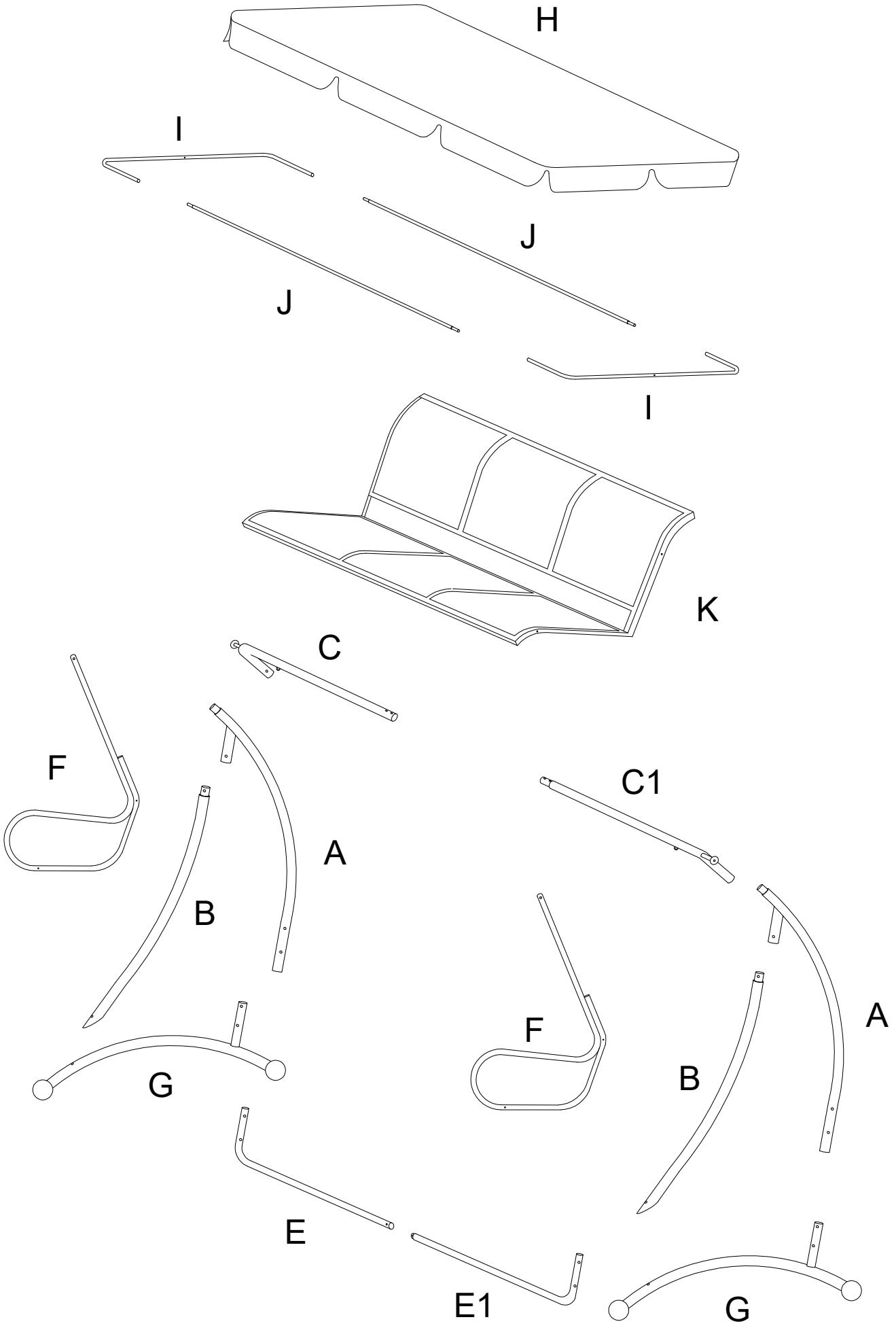

90'



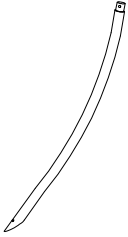
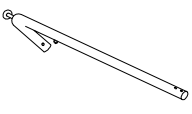
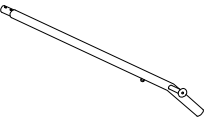
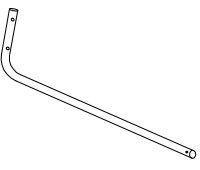
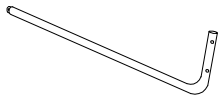
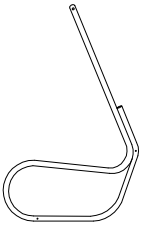
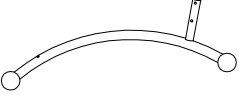
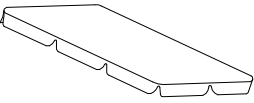

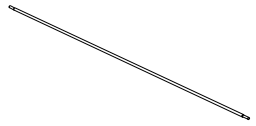
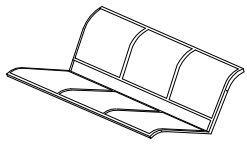

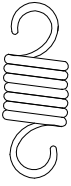
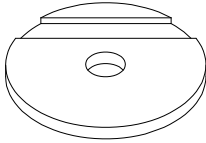
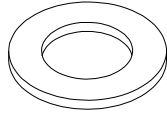
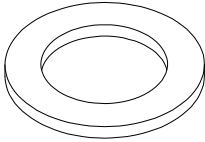
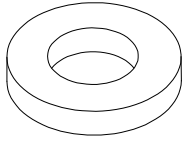
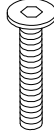
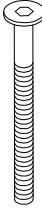
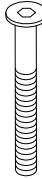
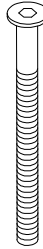
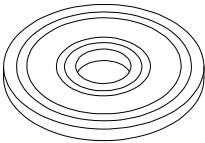
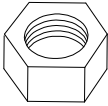
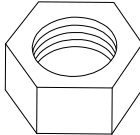
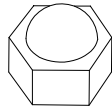
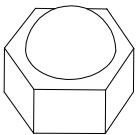

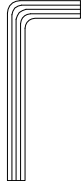
2



<p>A</p>  <p>x 2</p>	<p>B</p>  <p>x 2</p>	<p>C</p>  <p>x 1</p>	<p>C1</p>  <p>x 1</p>
<p>E</p>  <p>x 1</p>	<p>E1</p>  <p>x 1</p>	<p>F</p>  <p>x 2</p>	<p>G</p>  <p>x 2</p>
<p>H</p>  <p>x 1</p>	<p>I</p>  <p>x 2</p>	<p>J</p>  <p>x 2</p>	<p>K</p>  <p>x 1</p>

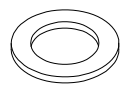
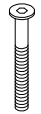
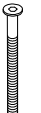



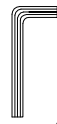

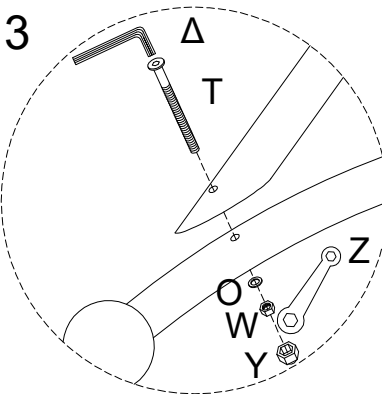
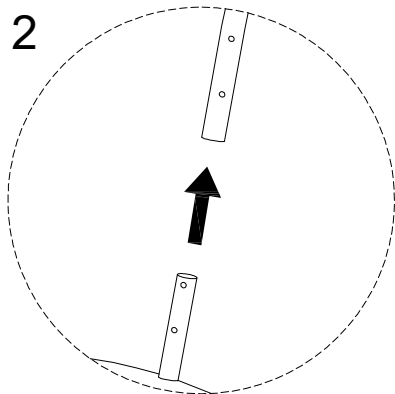
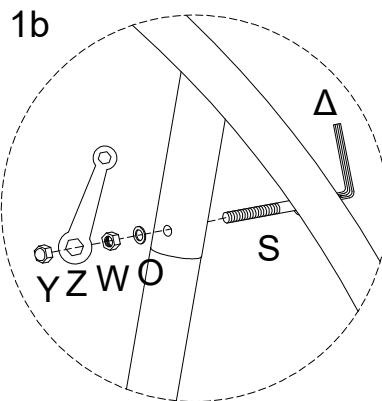
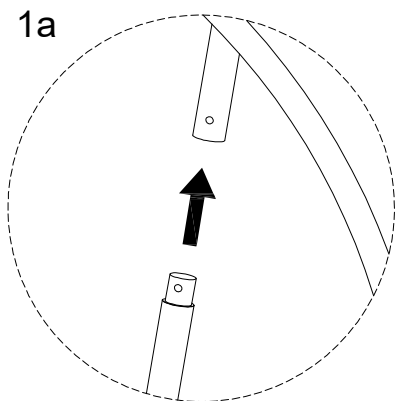
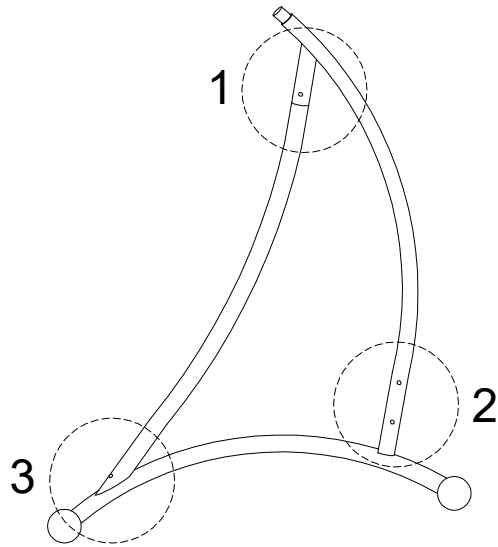
<p>L</p>  <p>x 2</p>	<p>M</p>  <p>x 4</p>	<p>N</p>  <p>x 5</p>	
<p>O</p>  <p>x 12</p>	<p>P</p>  <p>x 4</p>	<p>Q</p>  <p>M6 x 32</p> <p>x 1</p>	
<p>R</p>  <p>M6 x 78</p> <p>x 4</p>	<p>S</p>  <p>M8 x 58</p> <p>x 8</p>	<p>T</p>  <p>M8 x 80</p> <p>x 6</p>	
<p>U</p>  <p>x 2</p>	<p>V</p>  <p>x 5</p>	<p>W</p>  <p>x 12</p>	<p>X</p>  <p>x 5</p>
<p>Y</p>  <p>x 12</p>	<p>Z</p>  <p>x 1</p>	<p>Г</p>  <p>x 1</p>	<p>Δ</p>  <p>x 1</p>

1 x 2

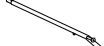
A  x 1	B  x 1	G  x 1	O  x 2	S  M8 x 58 x 1
T  M8 x 80 x 1	W  x 2	Y  x 2	Z  x 1	Δ  x 1

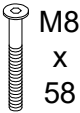



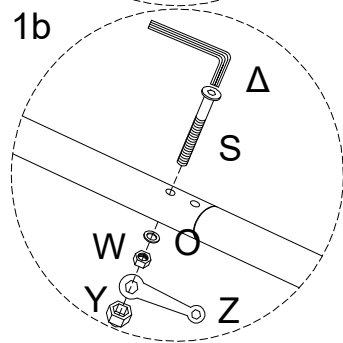
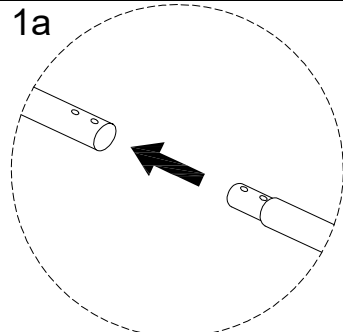
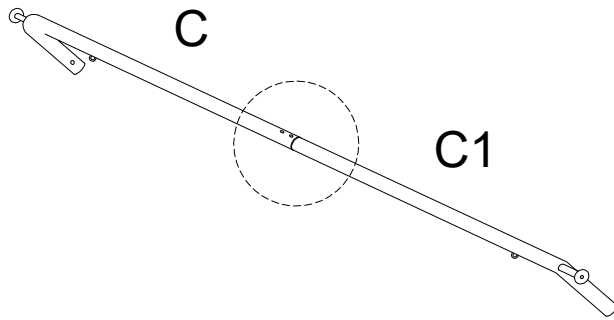

2

C	C1	O	S M8 x 58	W	Y	Z	Δ
							
x 1	x 1	x 2	x 2	x 2	x 2	x 1	x 1

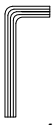

3

O	S M8 x 58	W	Y	Z	Δ
					
x 2	x 2	x 2	x 2	x 1	x 1

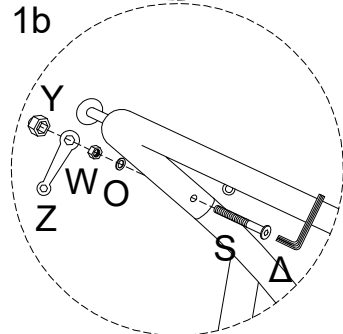
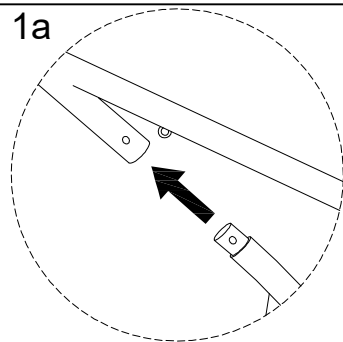
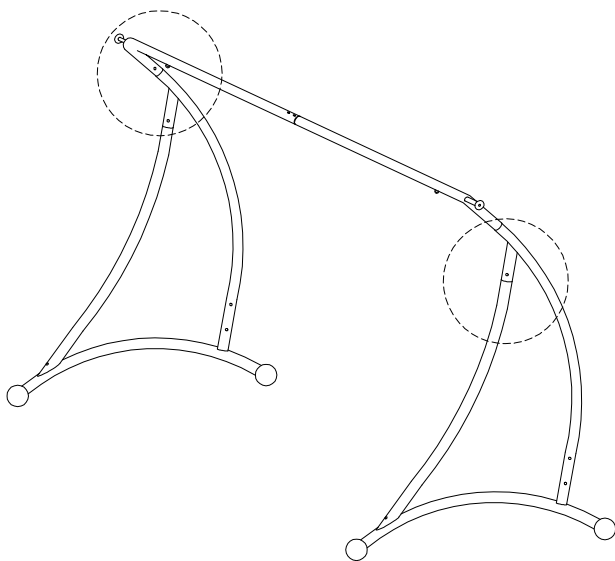

4

E	E1	N	Q M6 x 32	V	X	Z	Г
x 1	x 1	x 1	x 1	x 1	x 1	x 1	x 1

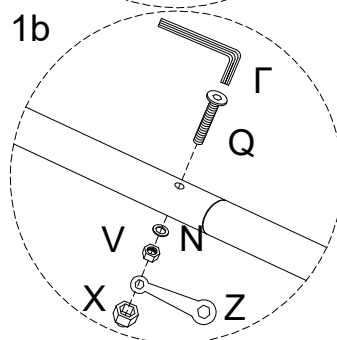
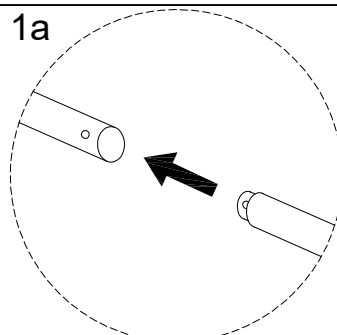
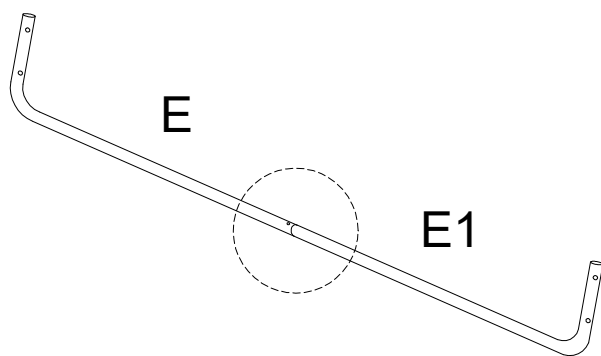





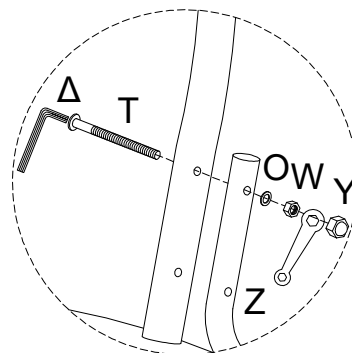
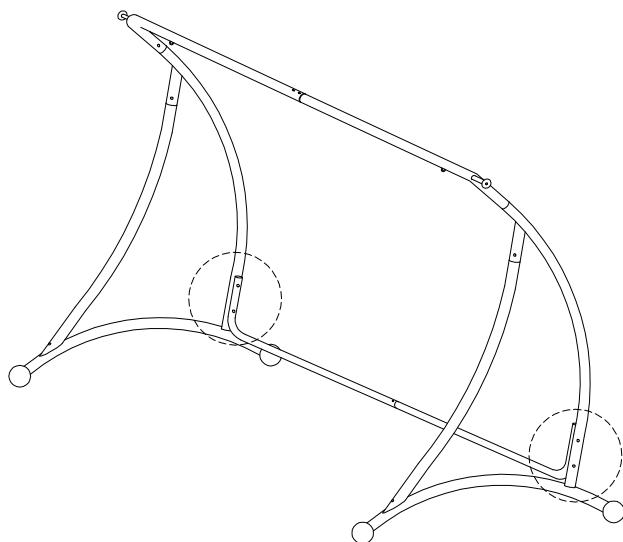

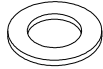

5

O	T M8 x 80	W	Y	Z	Δ
x 4	x 4	x 4	x 4	x 1	x 1

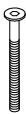

6

F  x 2	K  x 1	N  x 4	P  x 4	
R  M6 x 78 x 4	V  x 4	X  x 4	Z  x 1	Г  x 1

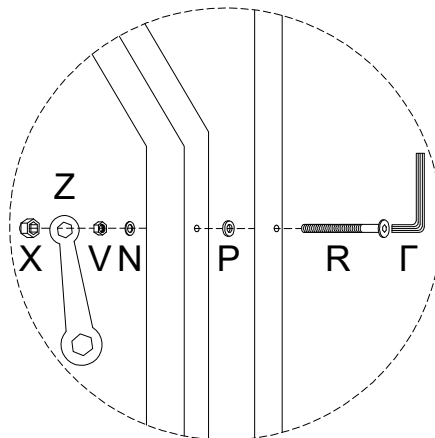
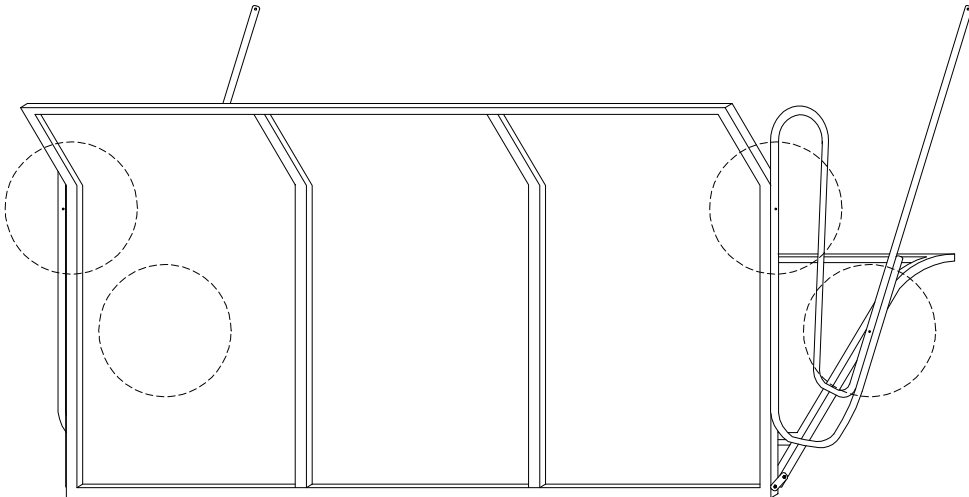

7

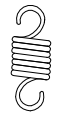
L

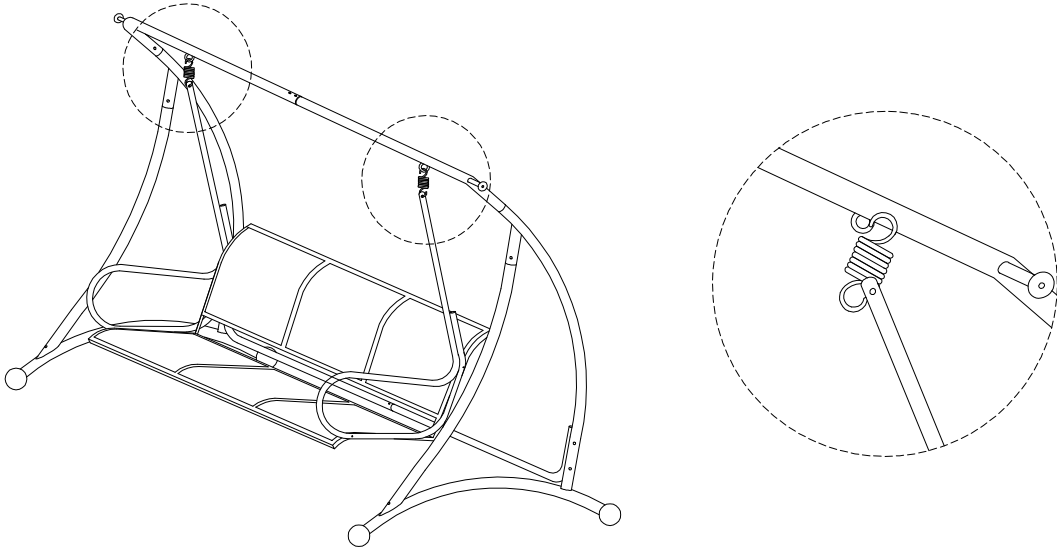
x 2

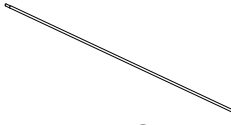

8

I

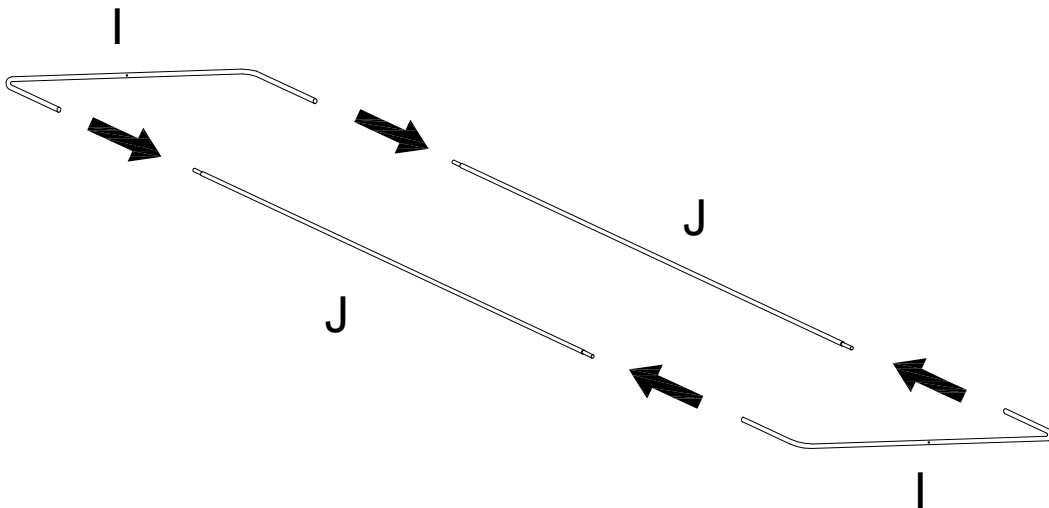
x 2

J

x 2

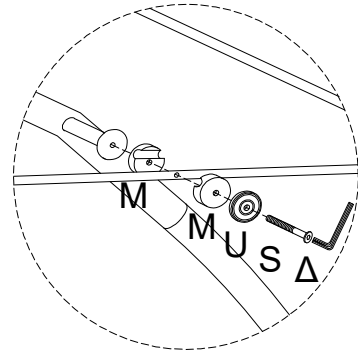
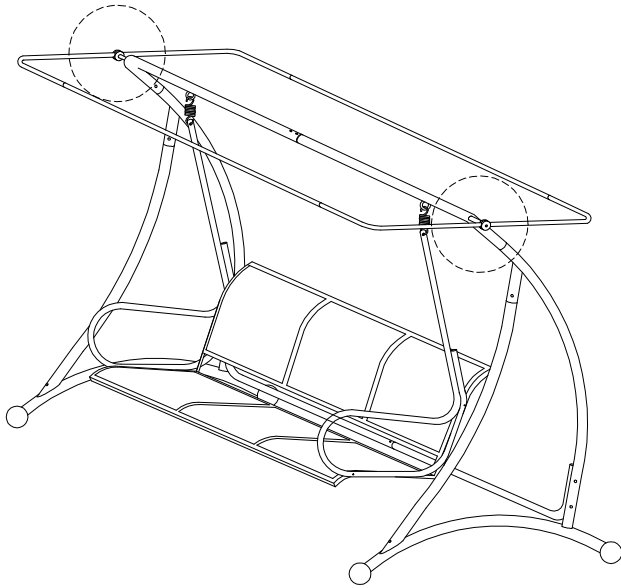
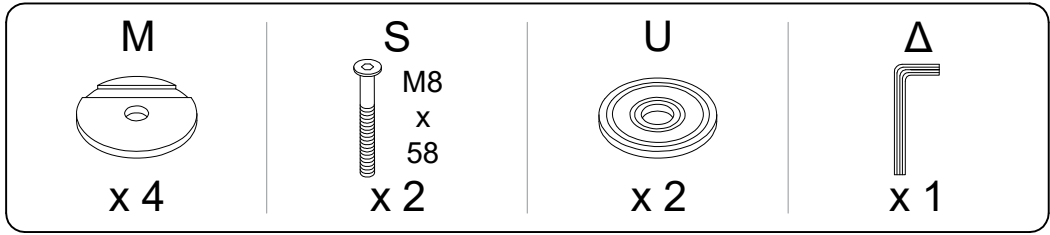

9



10

