

Assembly Instruction

CAUTION Read instruction carefully and turn electricity off at main circuit breaker panel before beginning installation.

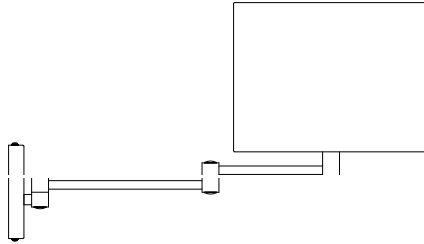

Care and Cleaning







To clean the outside of the fixture, use a dry or slightly dampened clean cloth (use clean water, never a solvent) to wipe the surface of the fixture.

To clear the inside of the fixture, first disconnect power to the fixture by turning off the circuit breaker or by removing the fuse at the fuse box. Next, use a dry or slightly dampened clean cloth (use clean water, never a solvent) to wipe the interior surface of the fixture.

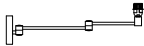
Do not use any cleaners with chemical, solvents or harsh abrasives. Use Only a dry soft cloth to dust or wipe carefully.

Estimated Assembly Time: 30 minutes

Part List and Hardware List

PIECE	DESCRIPTION	PICTURE	QUANTITY	PIECE	DESCRIPTION	PICTURE	QUANTITY
A	Wire Nut		3X	E	Lamp Body		1X
B	Mounting Plate		1X	F	Shade		1X
C	Mounting Screw		2X	G	Socket Ring		1X
D	Canopy Screw		2X	H	Bulb		1X

Installation

Step 1

Unpack all parts from cartons carefully.
Separate the Mounting Plate(B) from the Canopy of the lamp body(E) by removing 2 Canopy Screws(D).

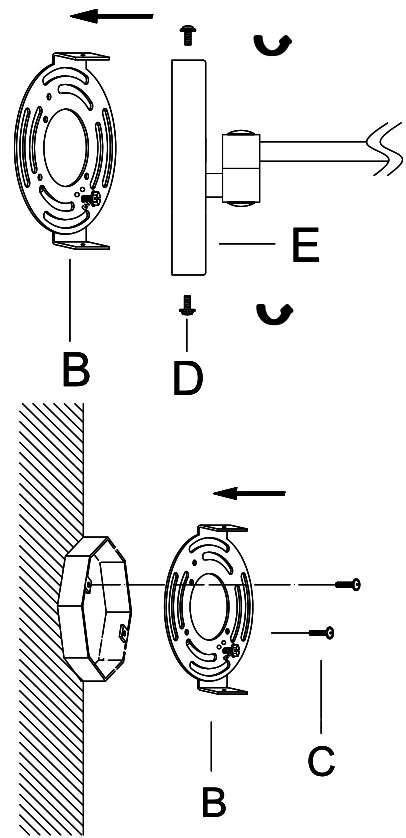

Step 2

Attach the Mounting Plate(B) to the junction box and fix it by turning 2 Mounting Screw(C) clockwise.

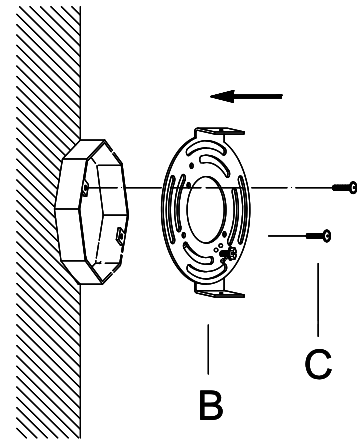

Step 3 Wire connection

Connect, Hot, Black or Red outlet Supply Wire to:	Connect, Neutral, White Outlet Supply Wire to:
Black	White
*Parallel Cord(round&smooth)	*Parallel Cord(square&ridged)
Clear, Brown, Gold or Black without Tracer(colored stripes)	Clear, Brwn, Gold or Black without Tracer(colored stripes)
Insulated Wire(not green)with copper metal conductor	Insulated Wire(not green)with Silver metal conductor

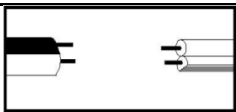

*Note: When parallel wire(SPTI&SPTII)is used. The neutral wire is square shaped and ridged and the hot wire will be round in shape and smooth.(See illustration on left)

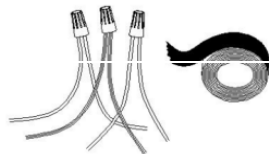

Step 4

Attach the Canopy of the lamp body(E) onto the Mounting Plate(B) and fix it with 2 Canopy Screws(D) clockwise.

Place the Shade(F) over the socket and fix it by turning the Socket Ring(G) clockwise till tight.

Insert the bulb (H) into the Socket. Be sure to use the bulb with wattage not exceed than specified on the fixture.

PLEASE USE TYPE "B" BULB MAX 40-WATT OR CFL BULB MAX 13-WATT OR LED MAX 9-WATT THERE IS 1 X 4W LED BULB IN THE BOX.

Adjust the arm of the Lamp Body(E) to your desired angle.

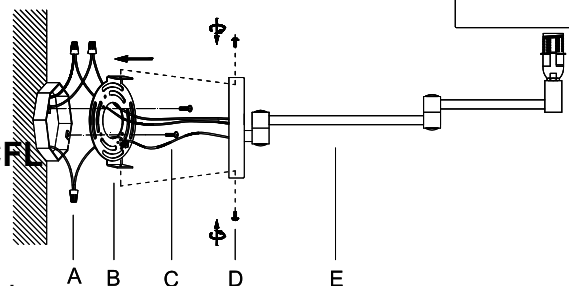
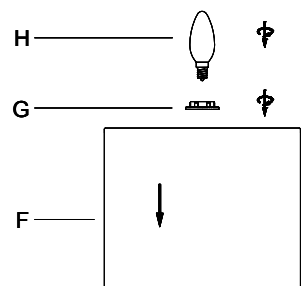

Step 5

Consult a qualified electrician to ensure correct branch circuit conductor

ENJOY YOUR LAMP