

A

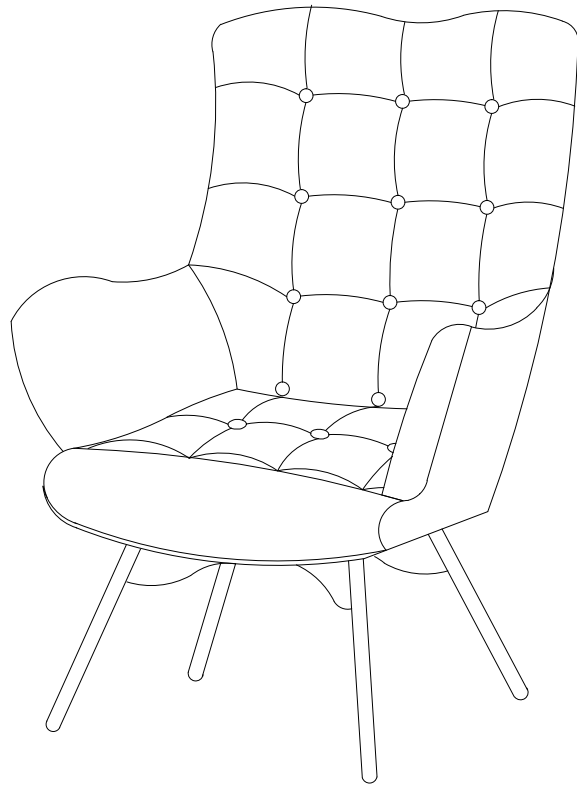

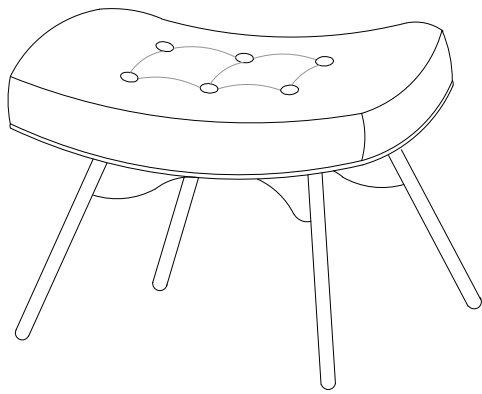



B

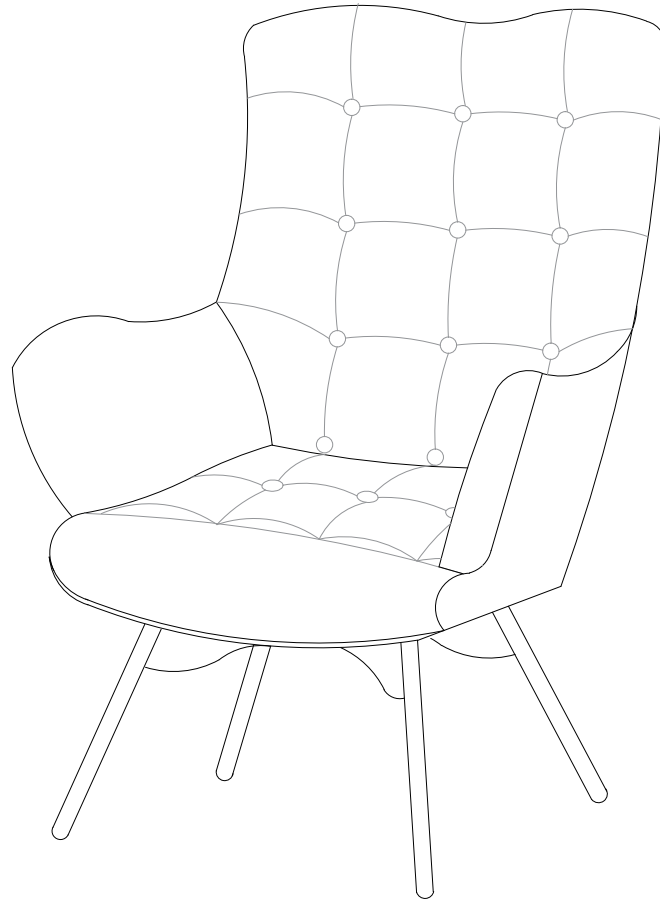

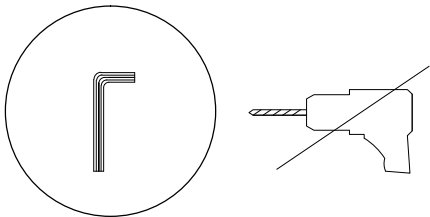
A

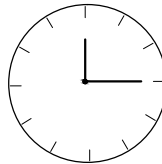
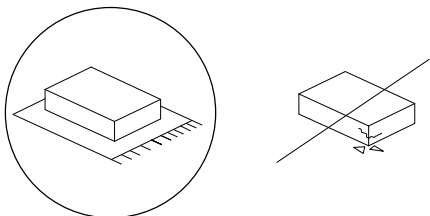

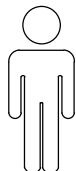
		
		<p>15'</p>
		
		<p>1</p>

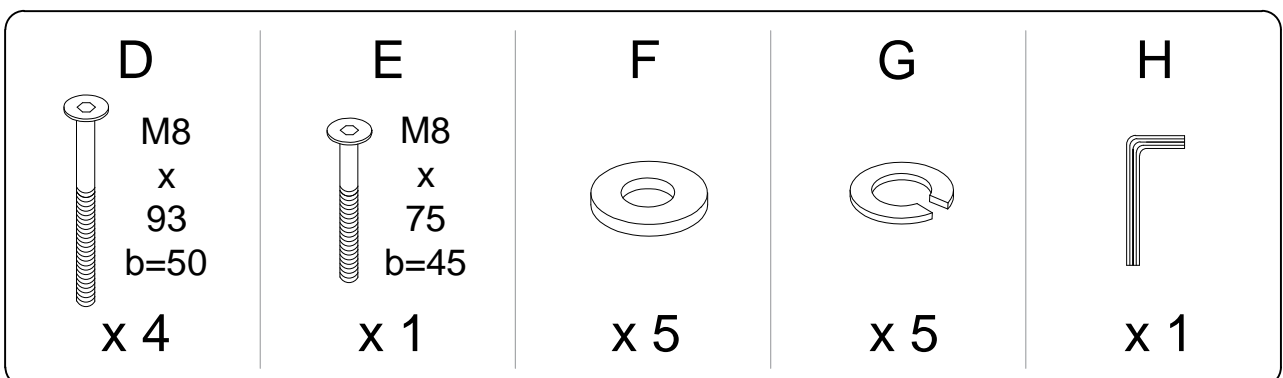
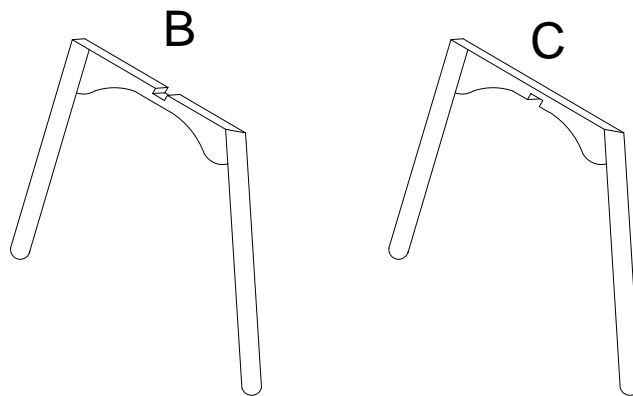
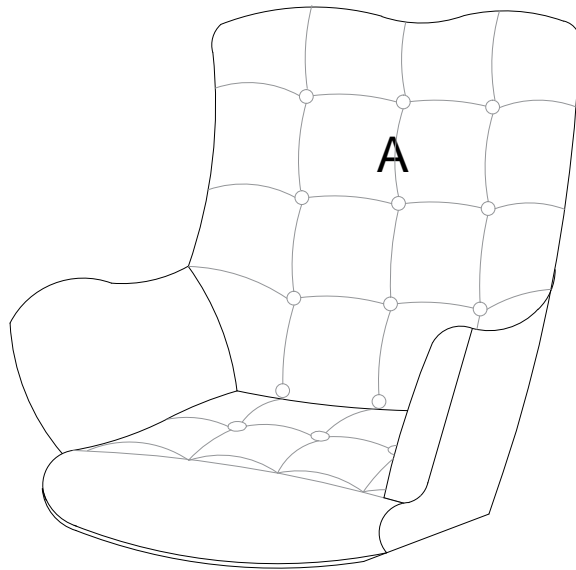
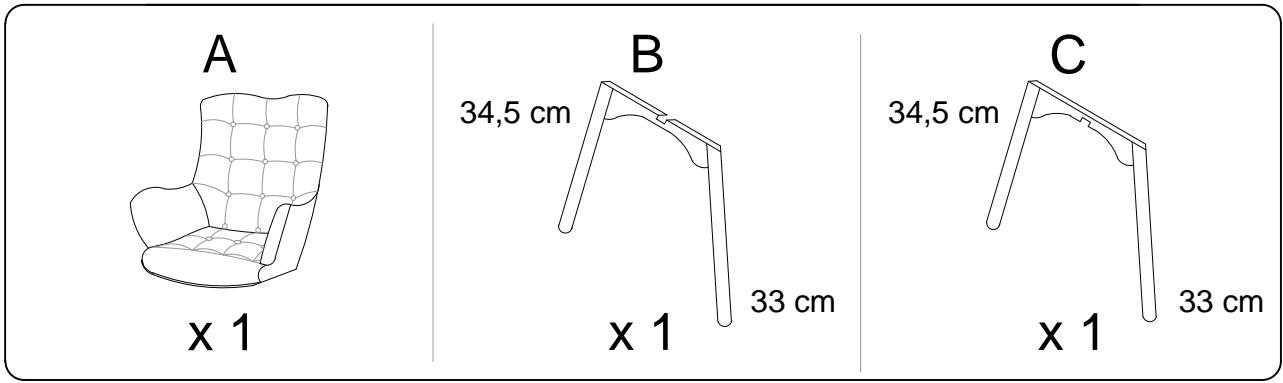



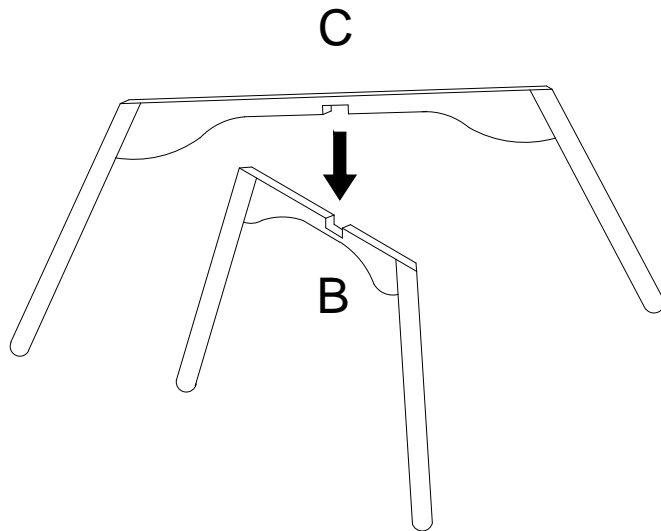
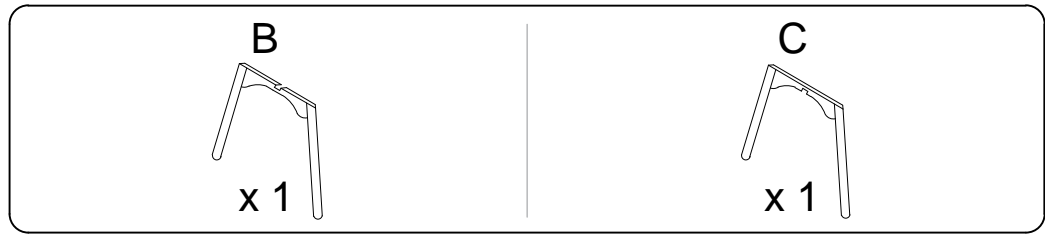

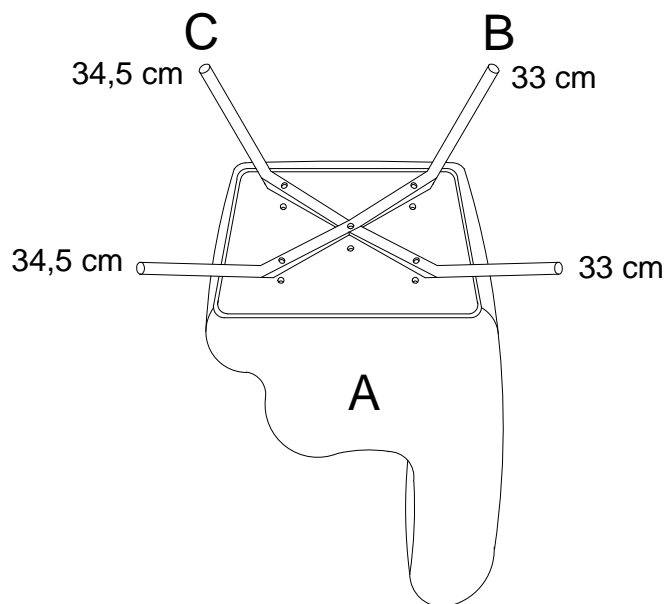
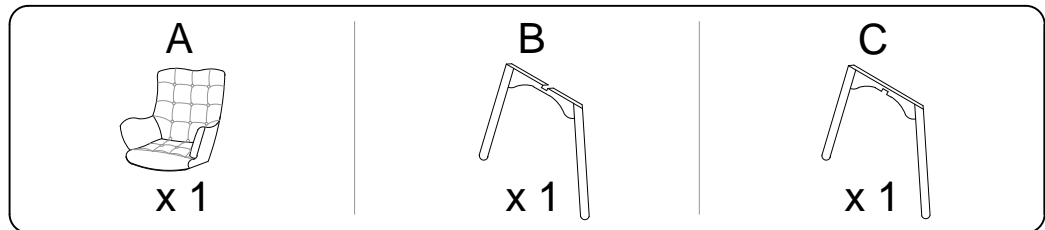

1



2

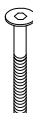

3

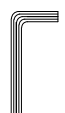
<p>A</p>  <p>x 1</p>	<p>B</p>  <p>x 1</p>	<p>C</p>  <p>x 1</p>	<p>D</p>  <p>M8 x 93 b=50</p> <p>x 4</p>
<p>E</p>  <p>M8 x 75 b=45</p> <p>x 1</p>	<p>F</p>  <p>x 5</p>	<p>G</p>  <p>x 5</p>	<p>H</p>  <p>x 1</p>

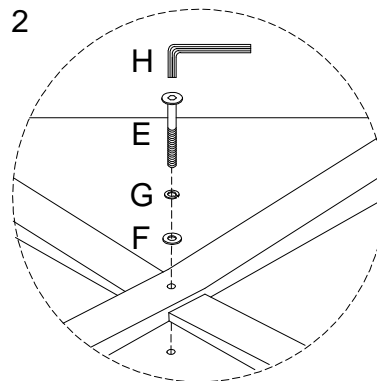
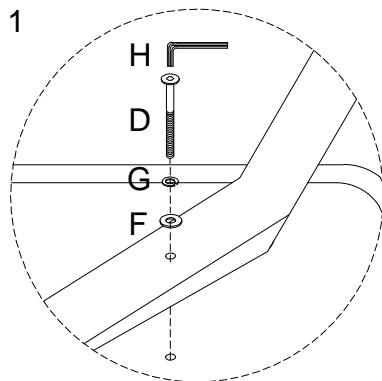
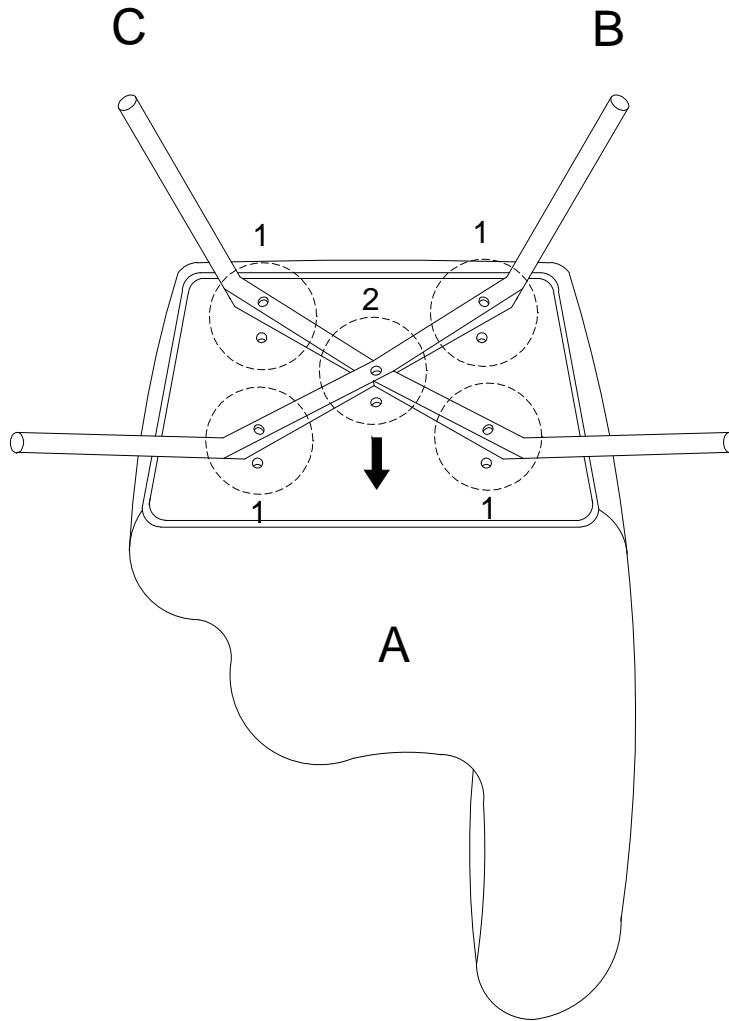

B

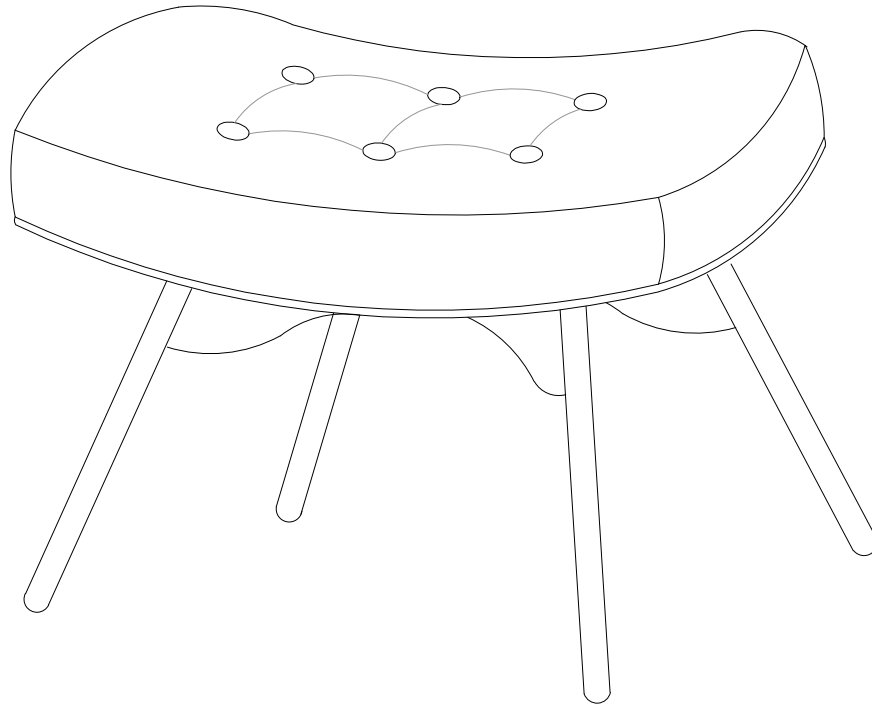

An icon showing an L-shaped metal bracket inside a circle. To its right is a power drill with a diagonal line through it, indicating it should not be used.	A warning triangle containing an exclamation mark.	A simple clock face showing the time 15 minutes.
An icon showing a rectangular block on a mat with a hatched pattern. To its right is a similar block with a diagonal line through it, indicating it should not be used.	A warning triangle containing an exclamation mark.	A simple icon of a person standing.

15'

1

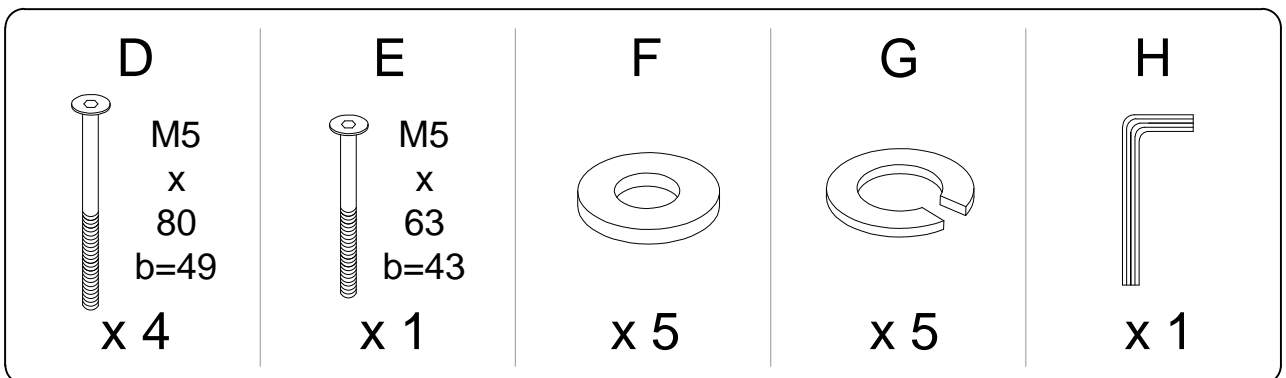
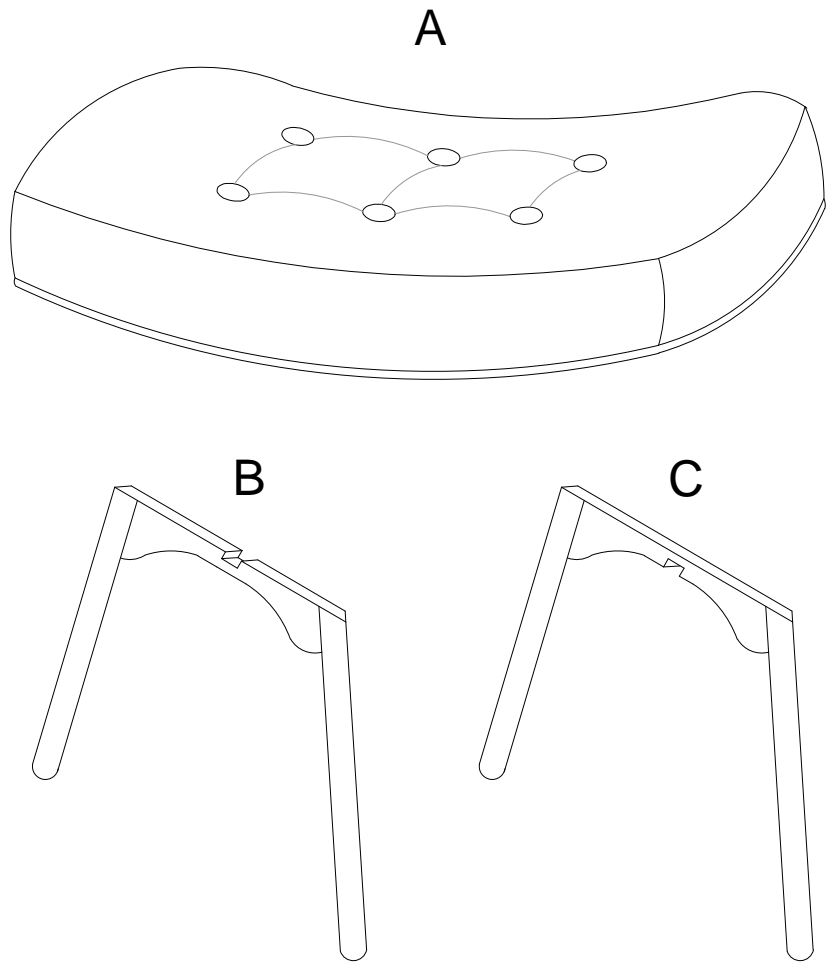
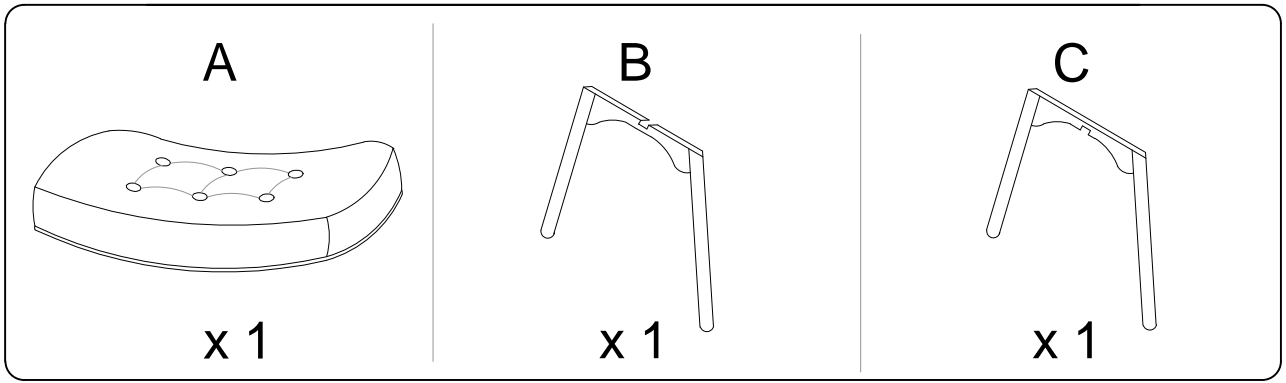

1

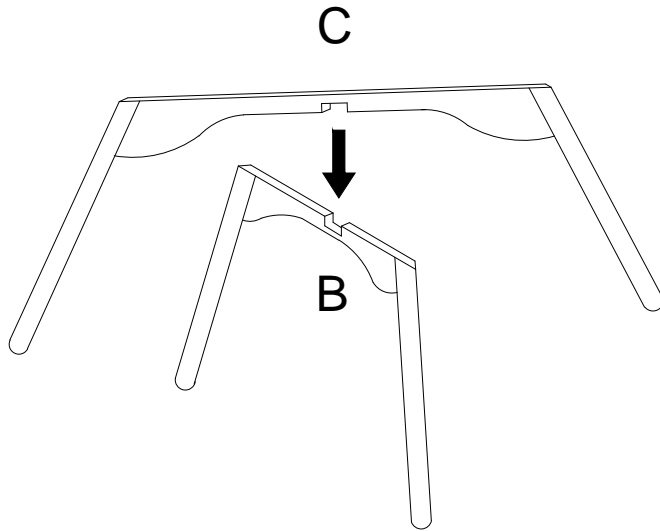
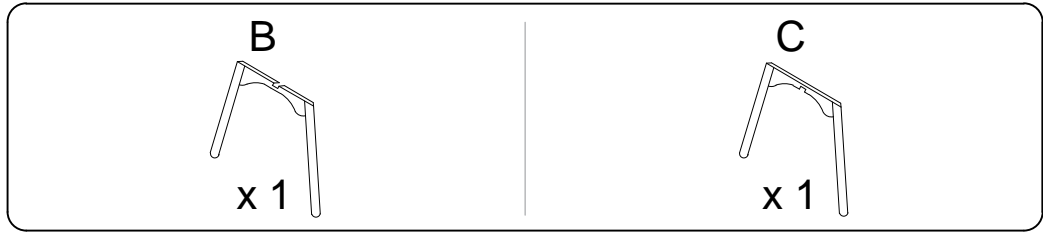

2

