

ASSEMBLY INSTRUCTIONS

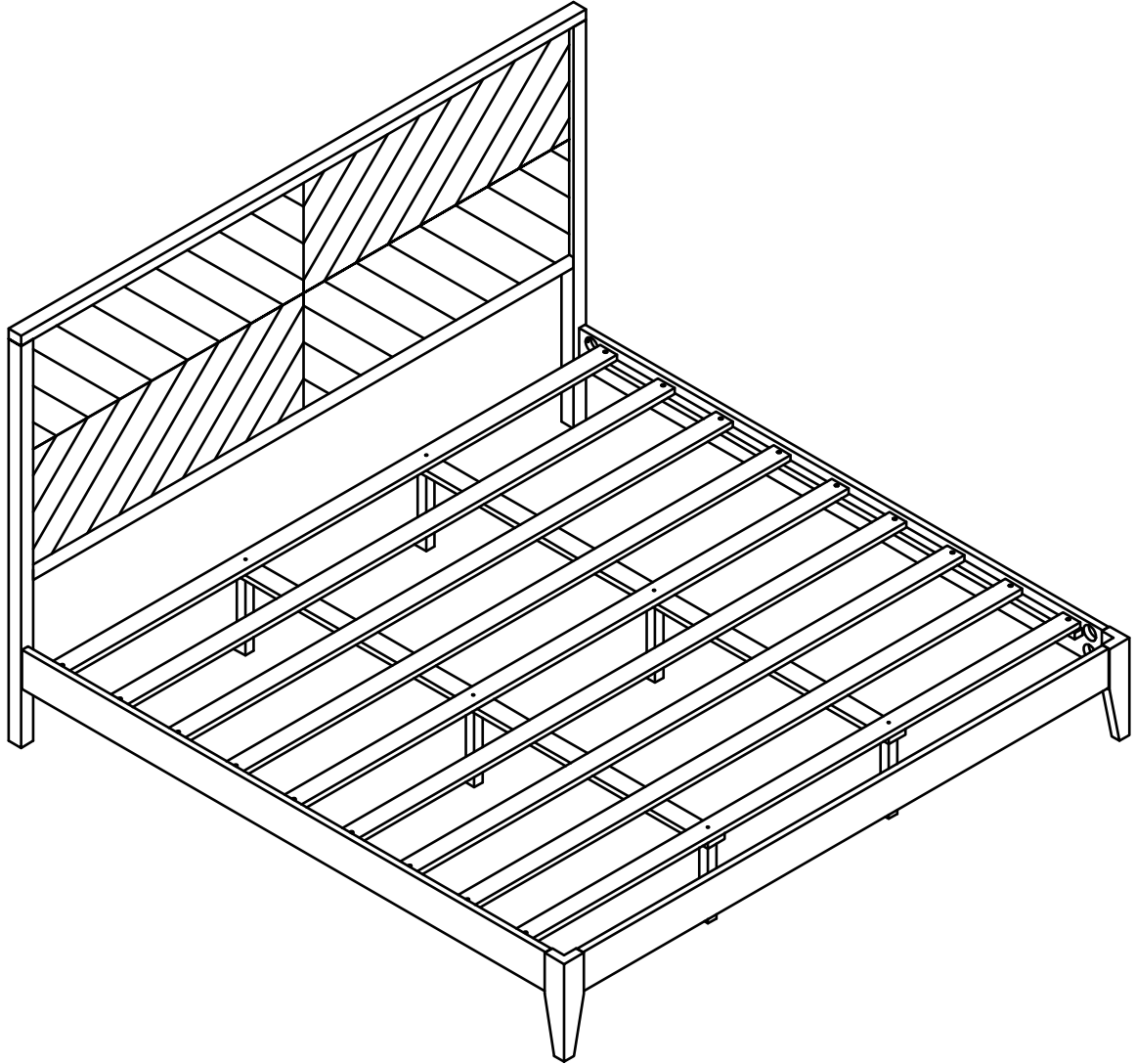

PRE ASSEMBLY INTRODUCTION

We understand building ready-to-assemble furniture can be a challenging experience for some. To help avoid confusion, we have provided some helpful tips that may speed up the process.

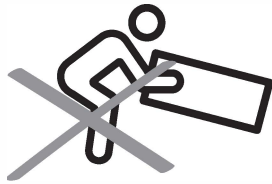

Teamwork

ALWAYS have at least two people to help with transporting and assembling the product to avoid potential injury and/or damage.

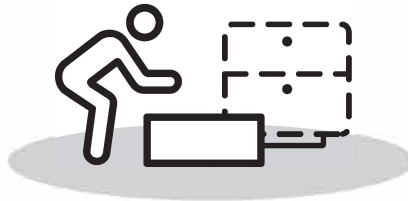
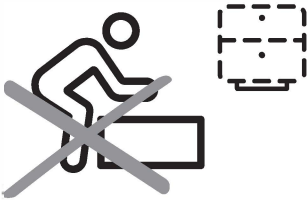

Suitable Location

Assembling near the area of the intended location is highly recommended.



Sufficient Space

Make sure you have enough space to move around during the assembly.



Avoid Scratches

Use cardboard, blankets or a carpeted area while assembling furniture to prevent scratches.

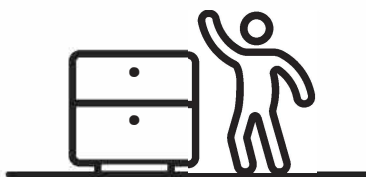
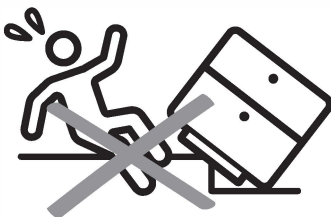

Flat Surface

Make sure the furniture rests on a flat and level surface with each leg evenly touching the floor.

PARTS

#A 1pc

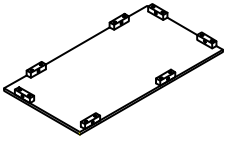

Panel HB

#B 1pc

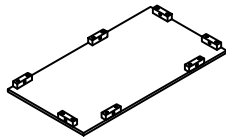

Panel HB

#C 1pc

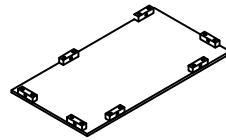

Panel HB

#D 1pc

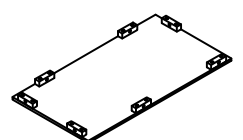

Panel HB

#E 1pc

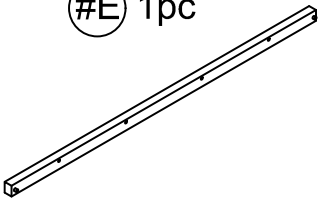

Top bar

#F 1pc

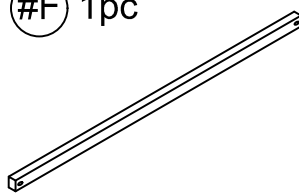

Bottom bar

#G 1pc

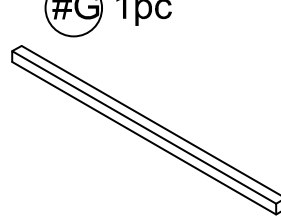

Leg HB right

#H 1pc

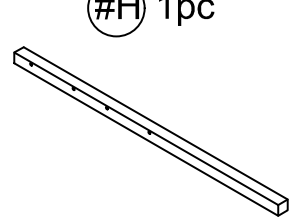

Leg HB left

#I 2pc



Legs FB

#J 1pc

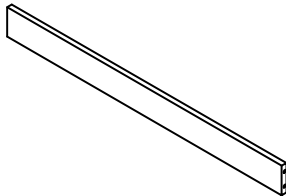

Panel FB

#K 2pcs

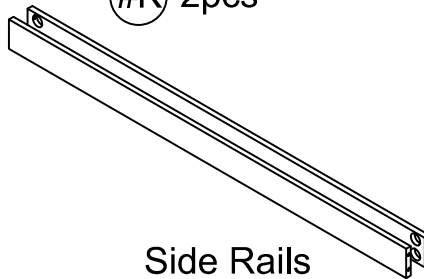

Side Rails

#L 9pcs

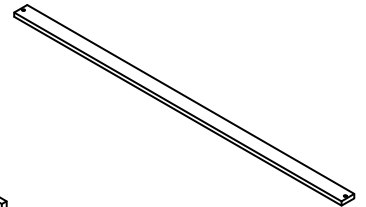

Panel FB

#M 6pcs

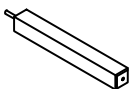

Support leg

#N 2pcs

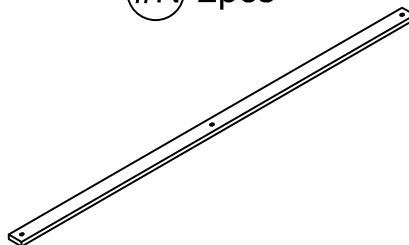

Support slat

HARDWARE

#1

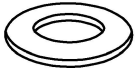

Flat Washer Ø1/4" x 26pcs

#2



Lock Washer Ø1/4" x 38pcs

#3



Bolt Ø1/4" x 35mm x 26pcs

#4

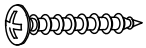

Screw Ø8 x 45mm x 4pcs

#5



Allen Key 4mm x 1pc

#6

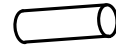

Wooden dowel Ø8 x 30mm x 2pcs

#7



Wooden dowel
Ø12 x 40mm x 4pcs

#8



Bolt Ø8 x 70mm x 12pcs

#9



Curved washers Ø8 x 70mm x12pcs

#10

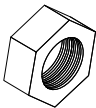

Nut Ø8x 10mm x 12pcs

#11

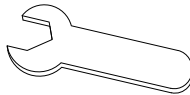

Allen Wrench 12mm x 1pc

#12

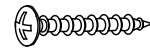

Screw Ø8 x 25mm x 18pcs

ASSEMBLY INSTRUCTIONS

Attach all Panel Left HB (top) (#A), Panel Left HB (bottom) (#B), Panel Right HB (bottom) (#C), Panel Right HB (top) (#D) together by using Flat washer (#1), Lock washer (#2), Bolt (#3) with Allen key (#5).

Step 1

Part (#A) 1pc

Part (#B) 1pc

Part (#C) 1pc

Part (#D) 1pc

Hardware (#1) 6pcs

Hardware (#2) 6pcs

Hardware (#3) 6pcs

Hardware (#5) 1pc

Hardware (#6) 2pcs

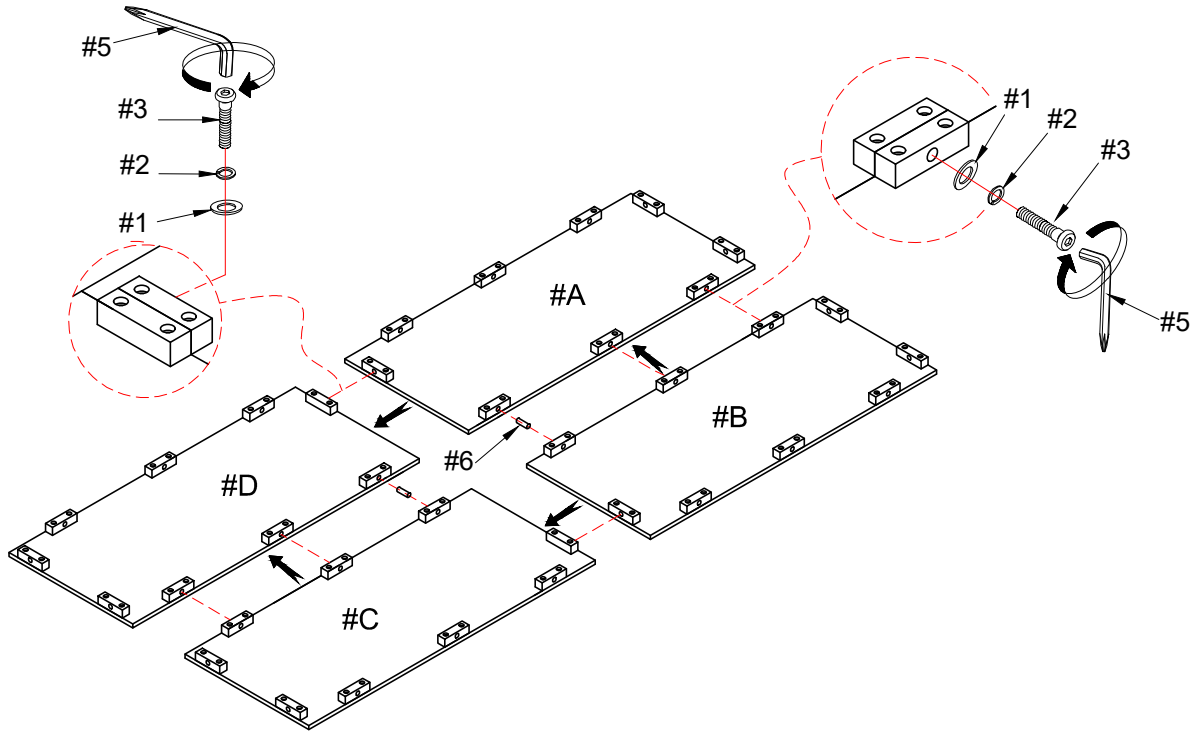

Attach Top bar (#E), Bottom bar (#F), Leg HB right (#G), Leg HB left (#H) on the Panel HB of Step 1 by using Flat washer (#1), Lock washer (#2), Bolt (#3) with Allen Key (#5) and Screw (#4), Wooden dowel (#7).

Step 2

Part (#E) 1pc

Part (#F) 1pc

Part (#G) 1pc

Part (#H) 1pc

Hardware (#1) 20pcs

Hardware (#2) 20pcs

Hardware (#3) 20pcs

Hardware (#4) 4pcs

Hardware (#5) 1pc

Hardware (#7) 4pcs

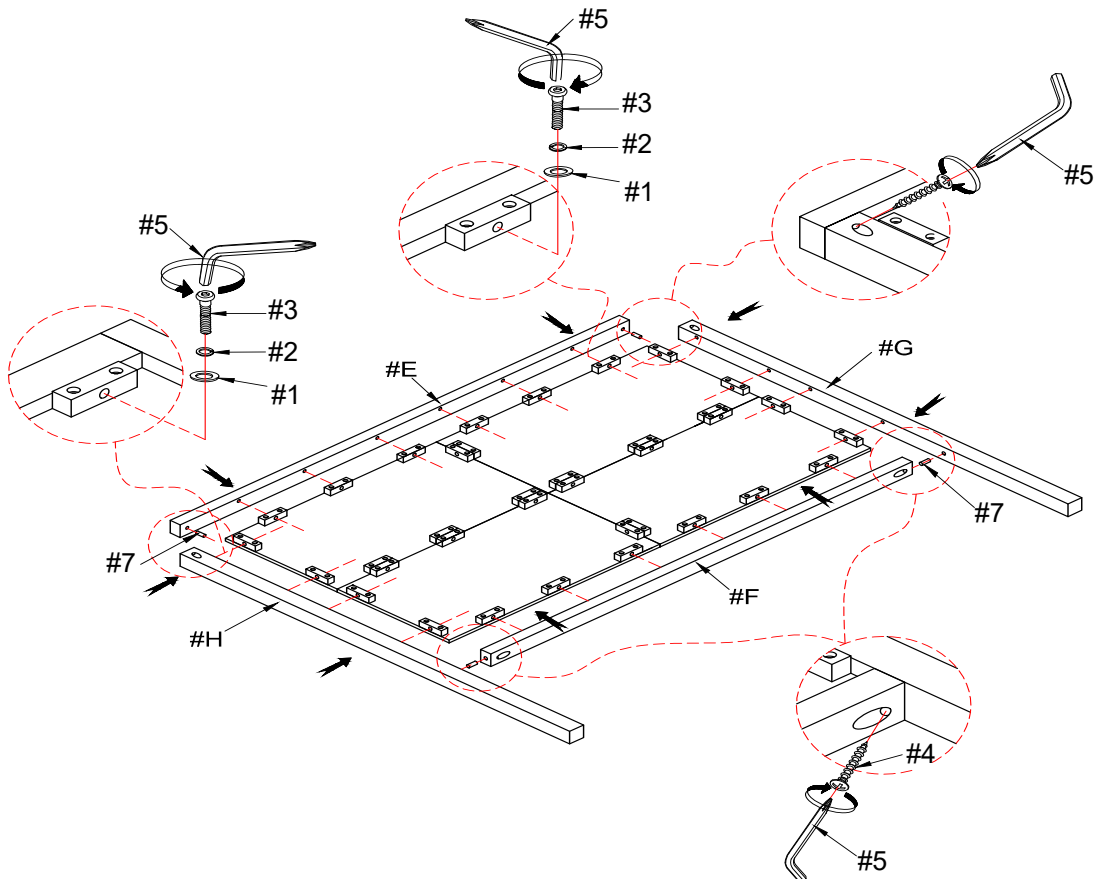

ASSEMBLY INSTRUCTIONS

Attach Panel FB (#J), on the Leg FB (#I) by using Nut (#10), Lock washer (#2), Curved washer (#9), Bolt (#8) with Allen Wrench (#11).

Step 3

Part (#I) 2pcs

Part (#J) 1pc

Hardware (#8) 4pcs

Hardware (#9) 4pcs

Hardware (#2) 4pcs

Hardware (#10) 4pcs

Hardware (#11) 1pc

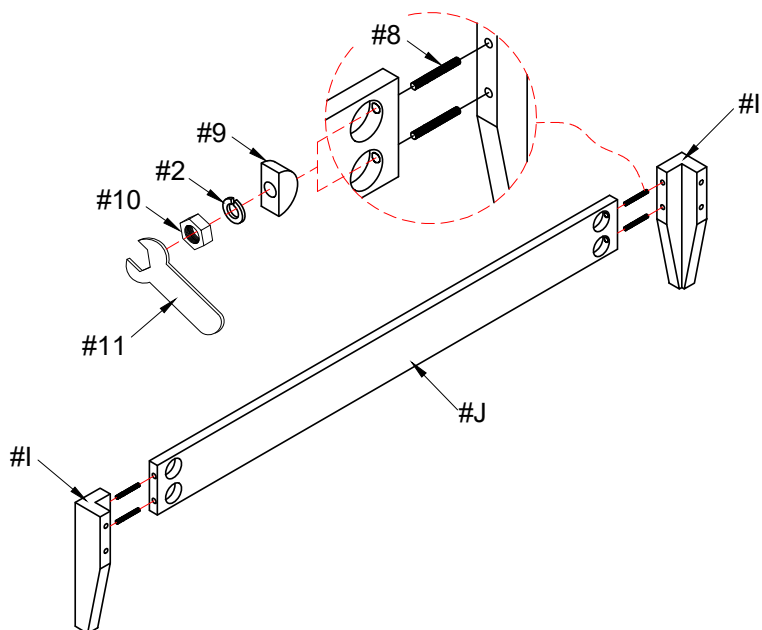

Step 4

Attach Side rails (#K), on the Head board and Footboard by using Nut (#10), Lock washer (#2), Curved washer (#9), Bolt (#8) with Allen Wrench (#11).

Part (#K) 2pcs

Hardware (#8) 8pcs

Hardware (#9) 8pcs

Hardware (#2) 8pcs

Hardware (#10) 8pcs

Hardware (#11) 1pc

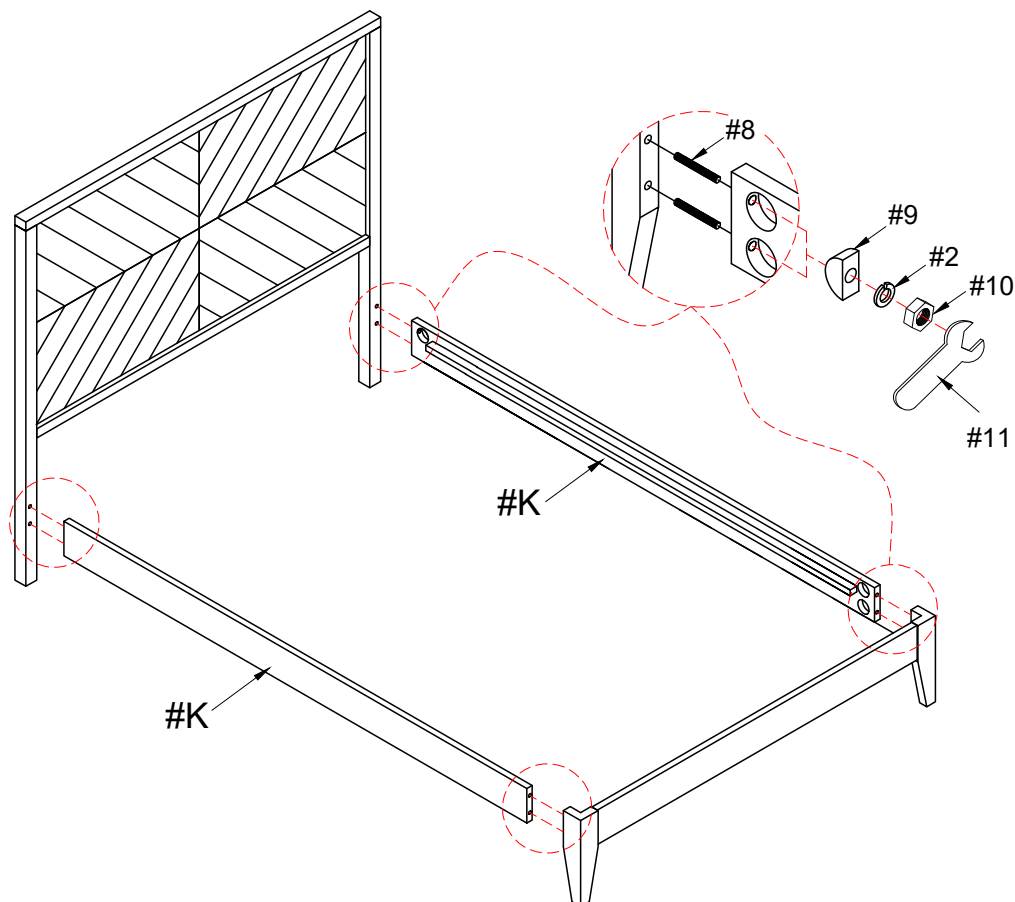

ASSEMBLY INSTRUCTIONS

Step 5

Then using Screw (#12) to connect Slats (#L) with Side rails (#K).

Hardware #12 18pcs

Part #L 9pcs

Part #M 6pcs

Part #N 2pcs

