

ASSEMBLY INSTRUCTION

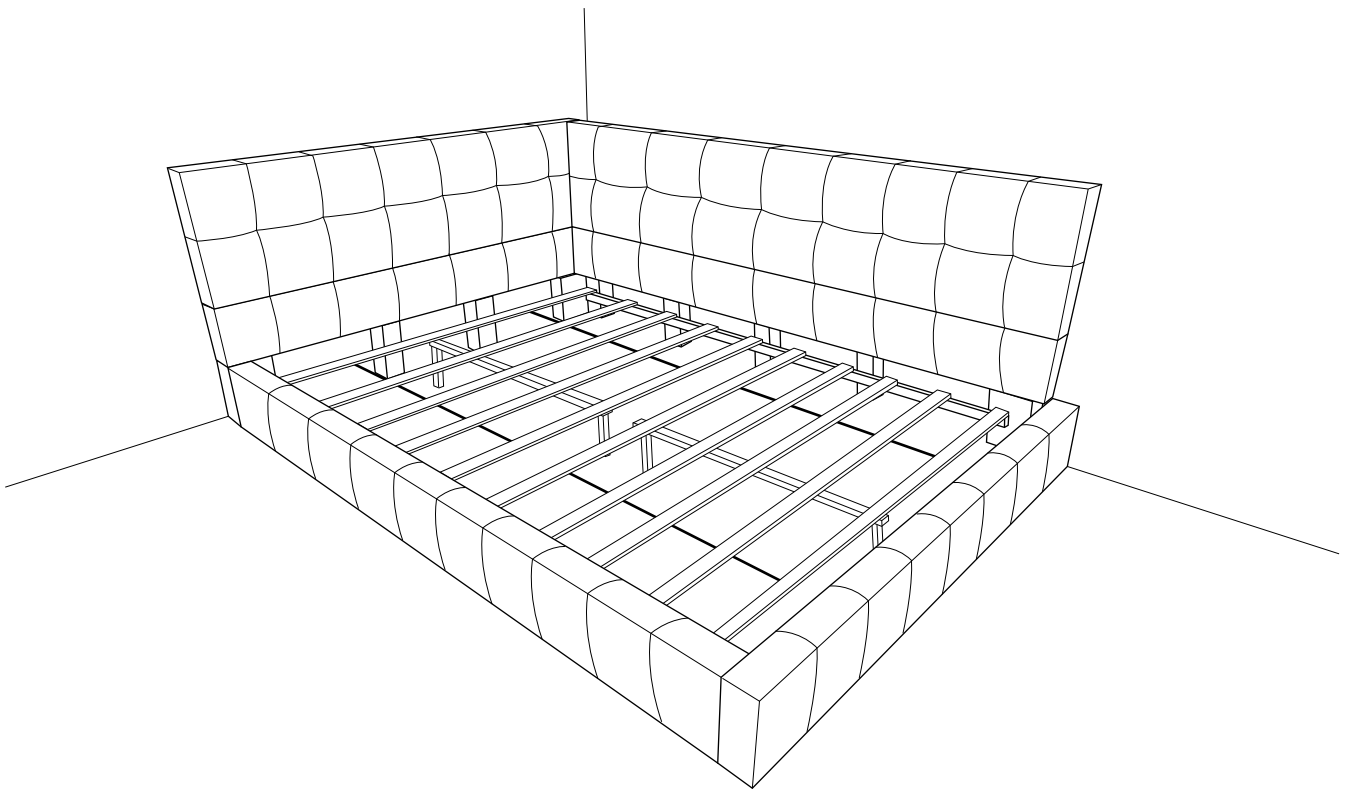

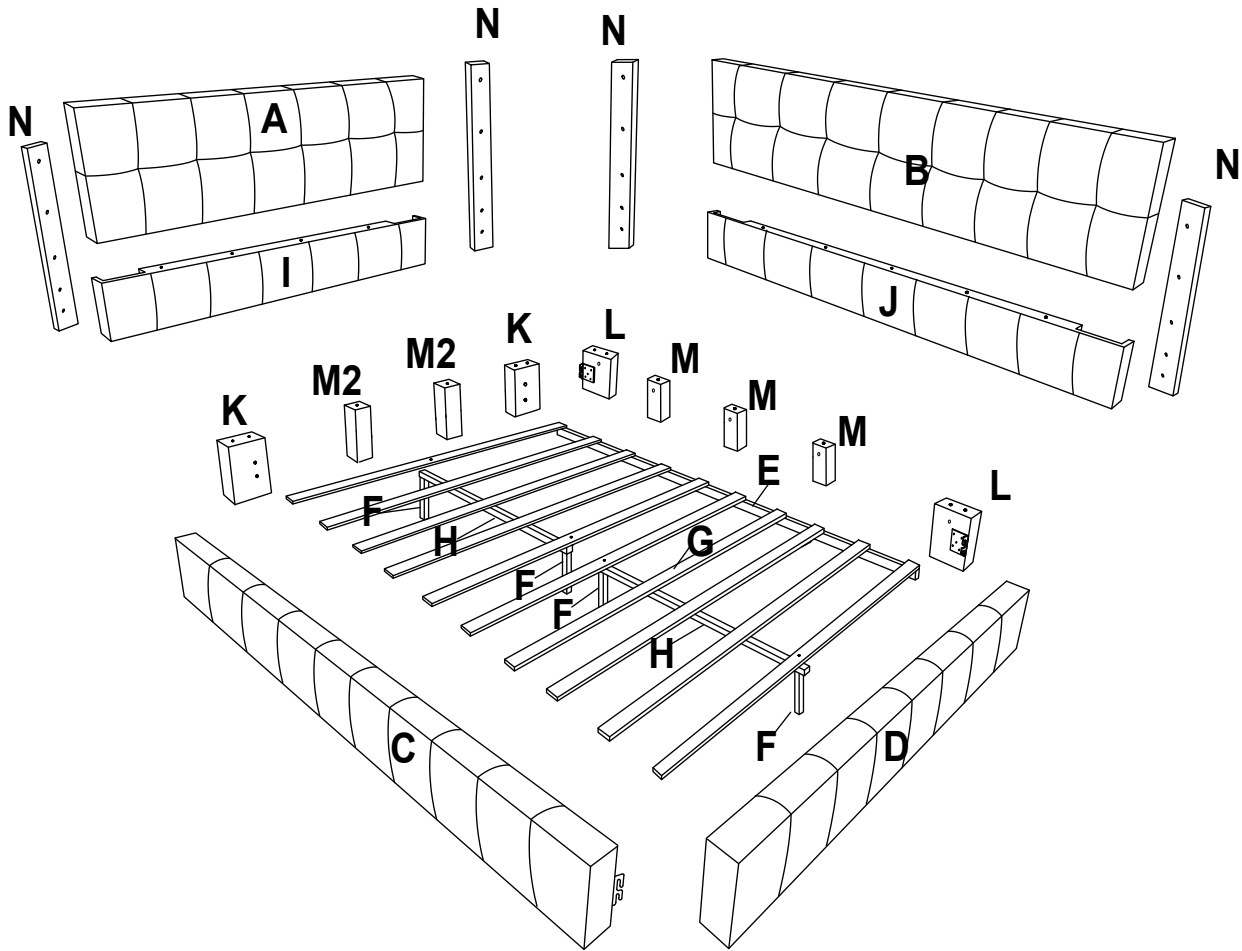

Detail View - CORNER BED (FULL)



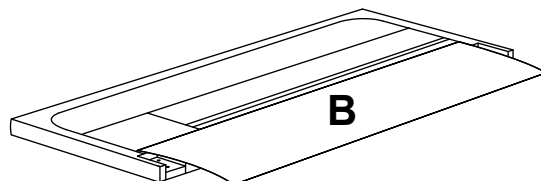

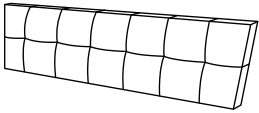
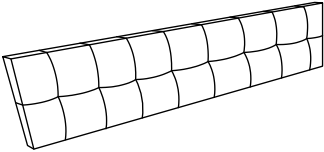
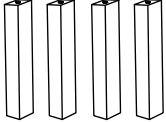
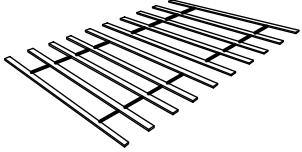
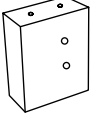
Bed Parts are shipped inside a compartment
in the back of the headboard.

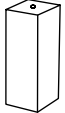
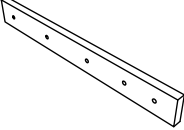

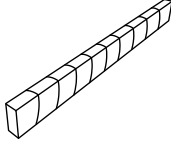
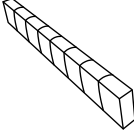
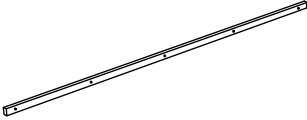
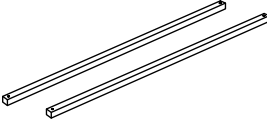
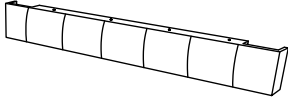
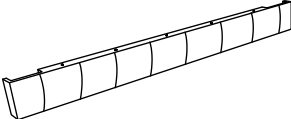
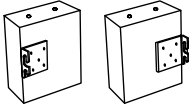
NO		QTY
A	Headboard Upper Panel 	1 pc
B	Side Rail Upper Panel 	1 pc
F	Center Support Leg 	4 pcs
G	Bed Slat 	10 pcs
K	Large Bottom Leg 	2 pcs
M	Small Bottom Leg 	3 pcs
M 2	Small Bottom Leg 	2 pcs
N	Bed Frame Support Rail 	4 pcs

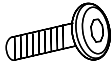
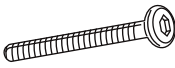
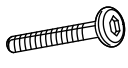
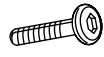
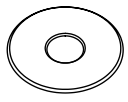
NO		QTY
C	Side Rail 	1 pc
D	Footboard 	1 pc
E	Slat Support 	1 pc
H	Center Support Rail 	2 pcs
I	Headboard Lower Panel 	1 pc
J	Side Rail Lower Panel 	1 pc
L	Large Bottom Leg (with bracket) 	2 pcs

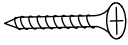
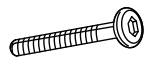
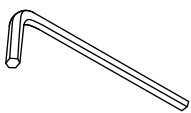
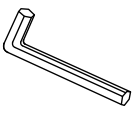
NO	HARDWARE LIST	QTY
1	JCBB M8 x 20mm 	8 pcs
2	JCBC M6 x 70mm 	4 pcs
3	JCBC M6 x 40mm 	5 pcs
4	JCBC M6 x 35mm 	20 pcs
5	Flat Washer M6 	42 pcs
6	Barrel Nut M6 	4 pcs
7	CSK M4 x 30mm 	20 pcs
8	JCBC M6 x 50mm 	22 pcs
9	Allen Key M4 	1 pc
10	Allen Key M5 	1 pc

Read this instruction carefully. Remove all wrapping material, staples and straps from the carton. See hardware and furniture part list for guidance. Be sure you have all wooden furniture parts on a clean and flat surface, such as carpet or rug, to prevent from being scratched.

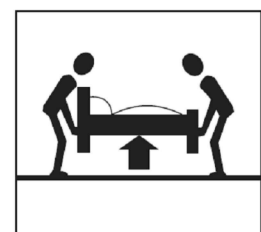
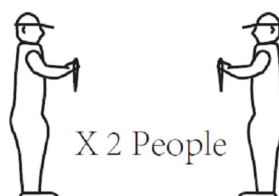
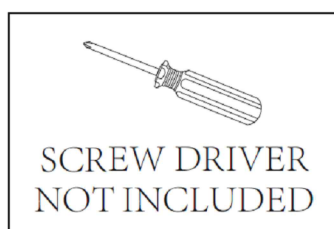

CAUTION :

1. Do not Full Tighten the nut or screw until all ready to assemble.
2. Do not Over Tighten the nut or screw to avoid causing damages to the thread.
3. Keep all hardware part out reach of children.

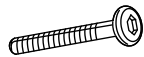

STEP 1

REMINDER: Please decide your bed placing angle before proceed assemble, kindly refer below Option 1 & Option 2 photos.

8	5
	
22 pcs	22 pcs

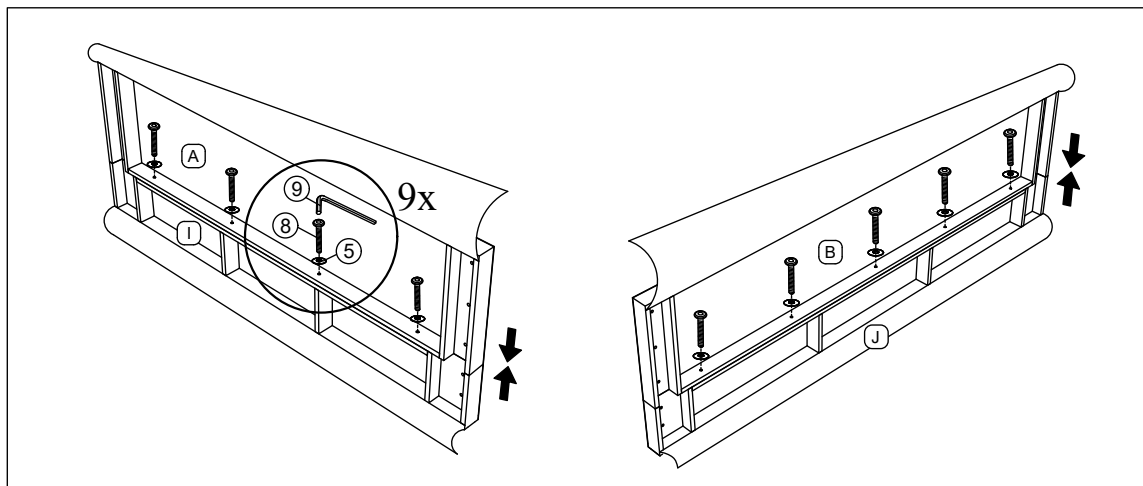

STEP 1.1

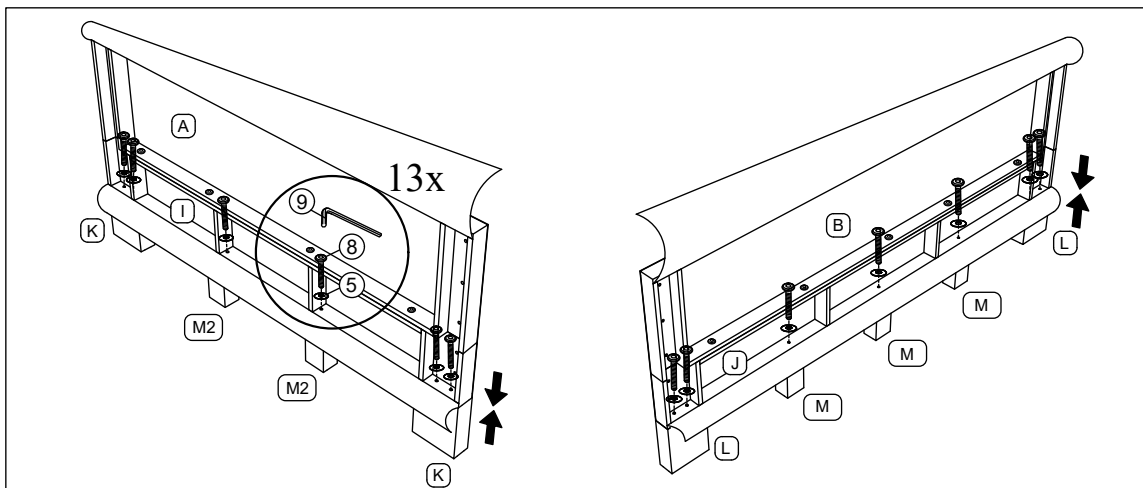

STEP 1.2

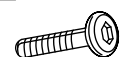

STEP 2

4	5
	
20 pcs	20 pcs

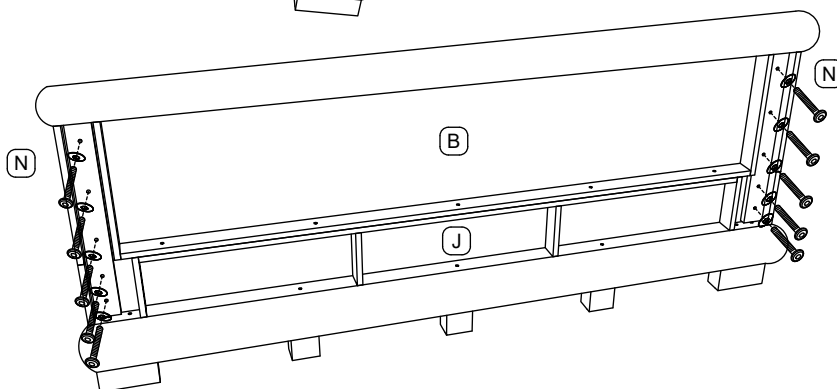
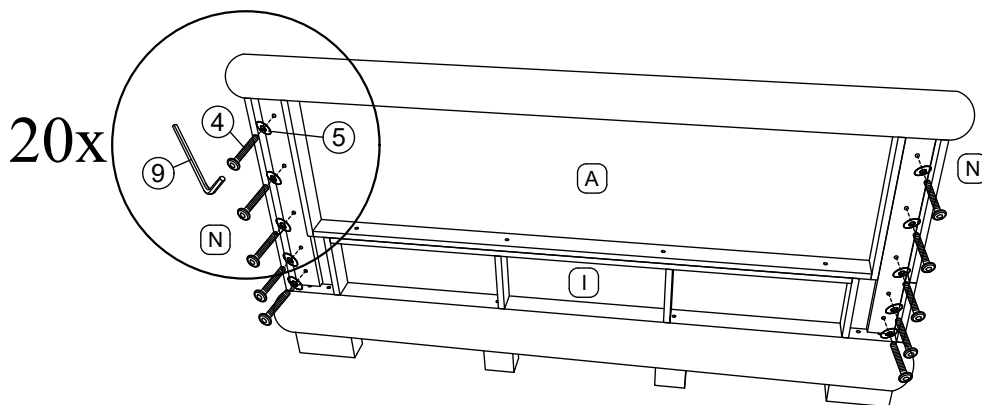

STEP 3

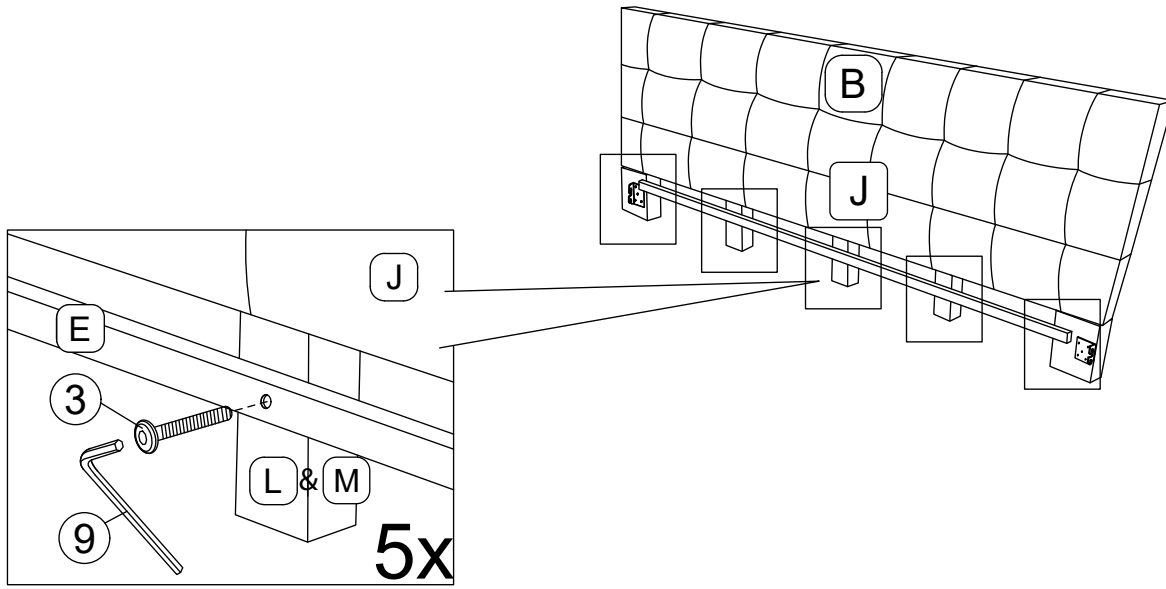
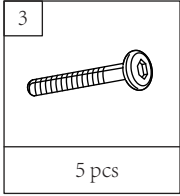

STEP 4

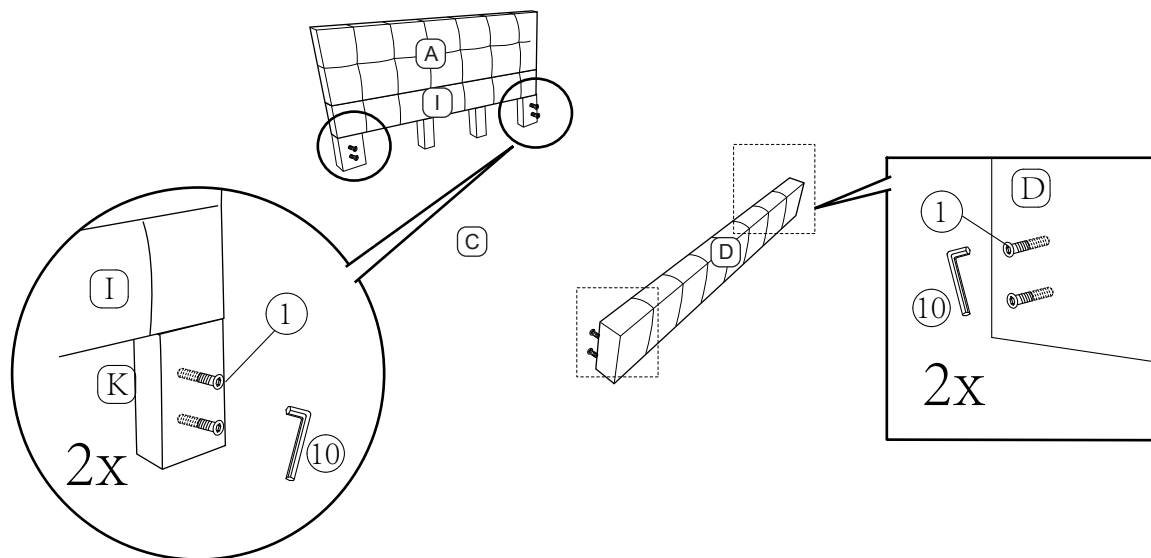
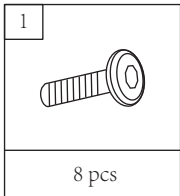

Do not fully tighten screws before completing step 5

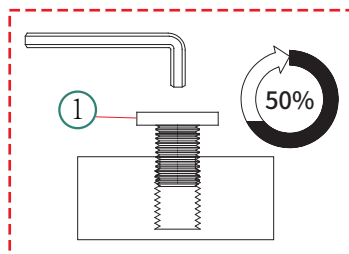

STEP 5

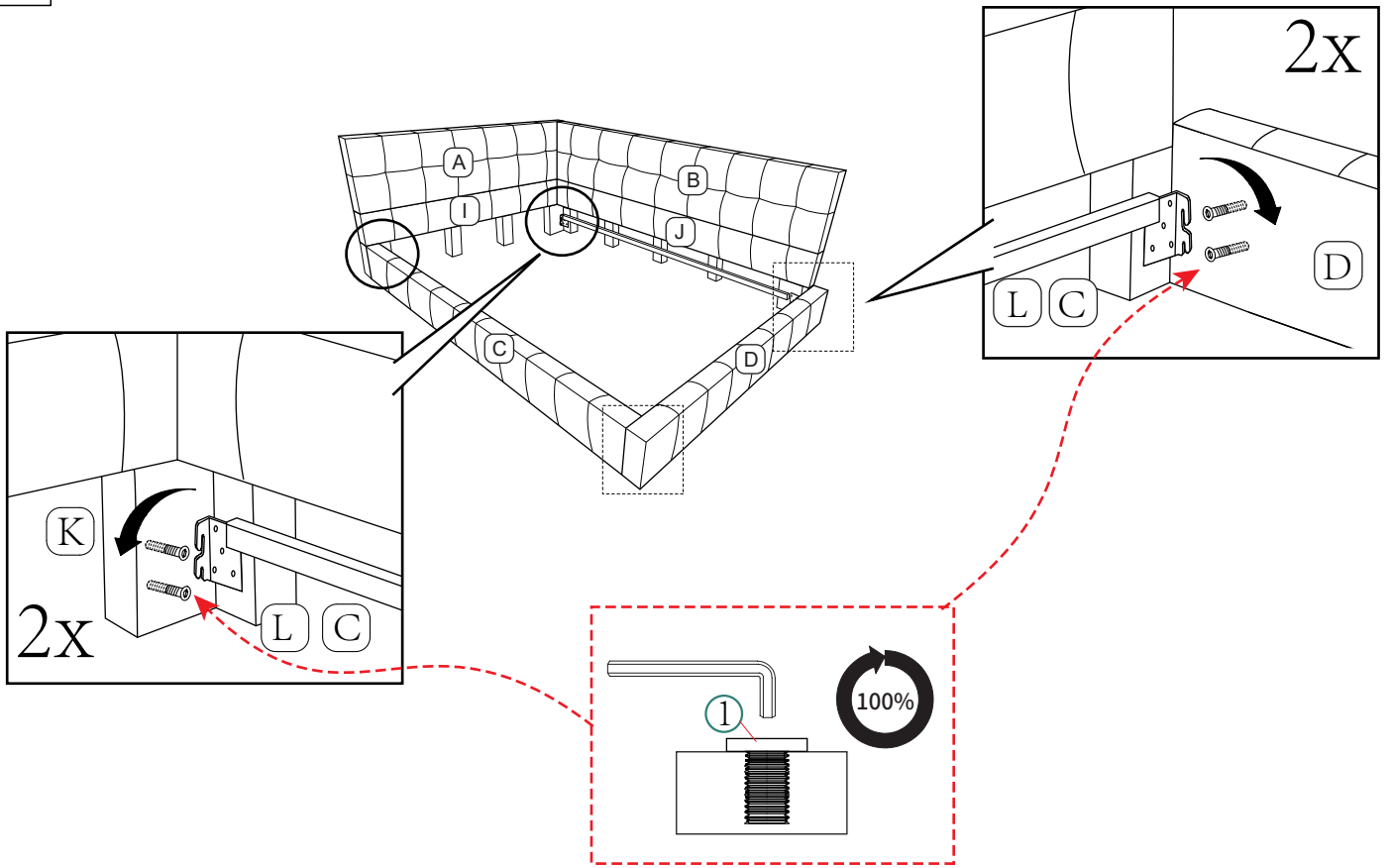

STEP 6

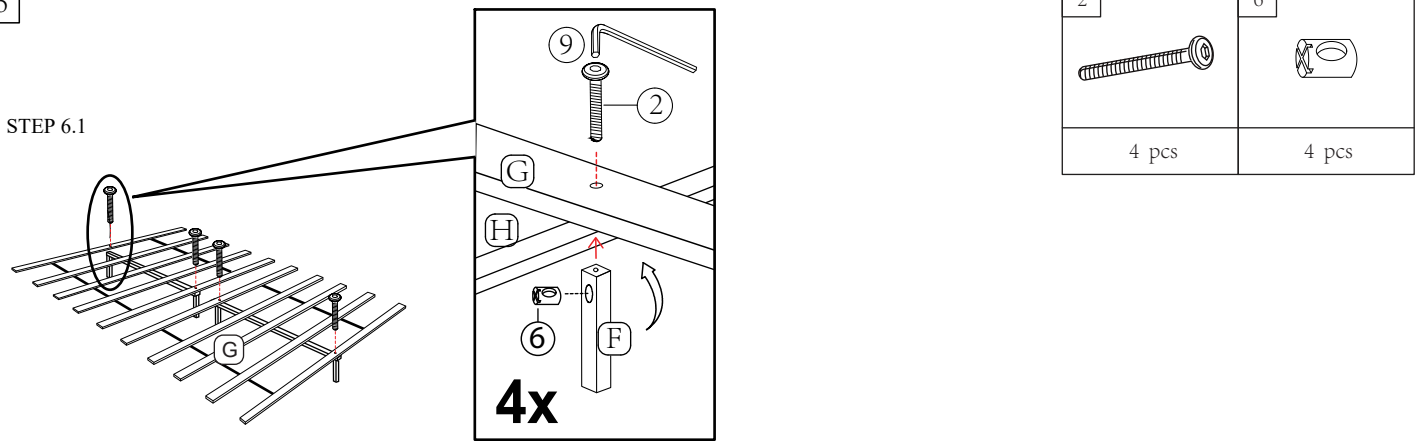

STEP 6.2

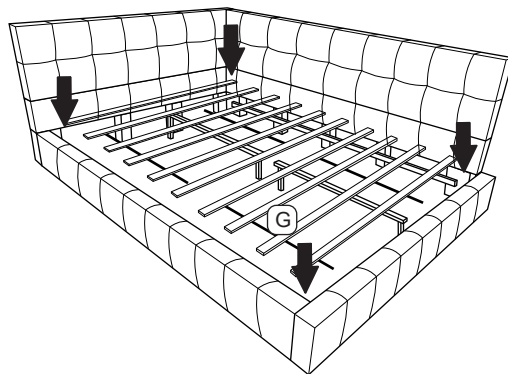

STEP 7

7



20 pcs

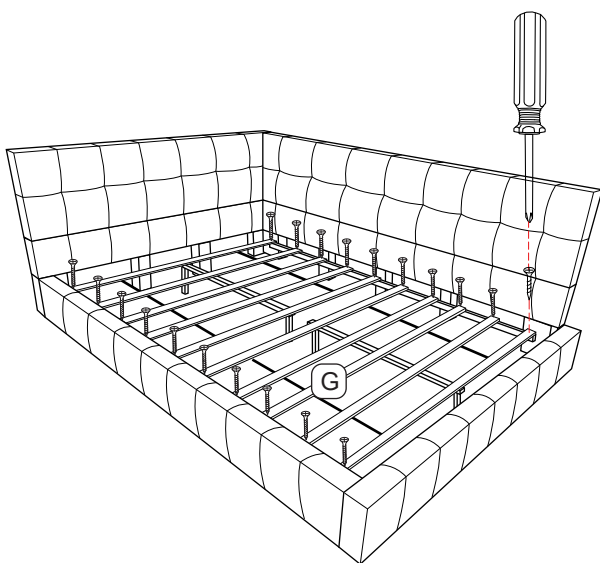

COMPLETED
ASSEMBLY



Place the bed against the wall.

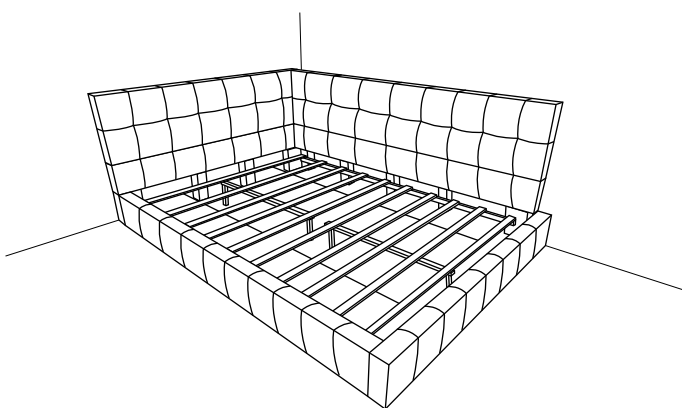

Option 1

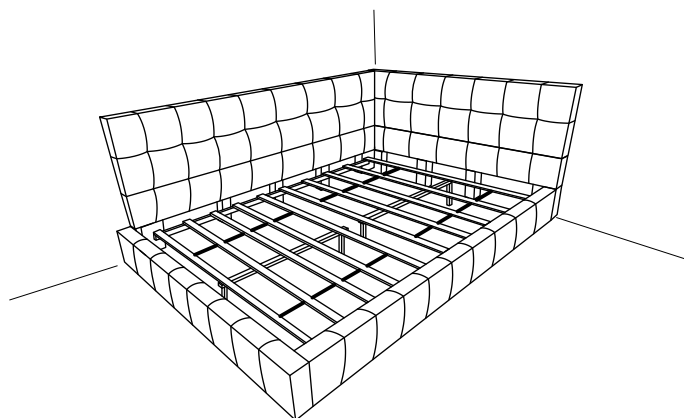

Option 2