

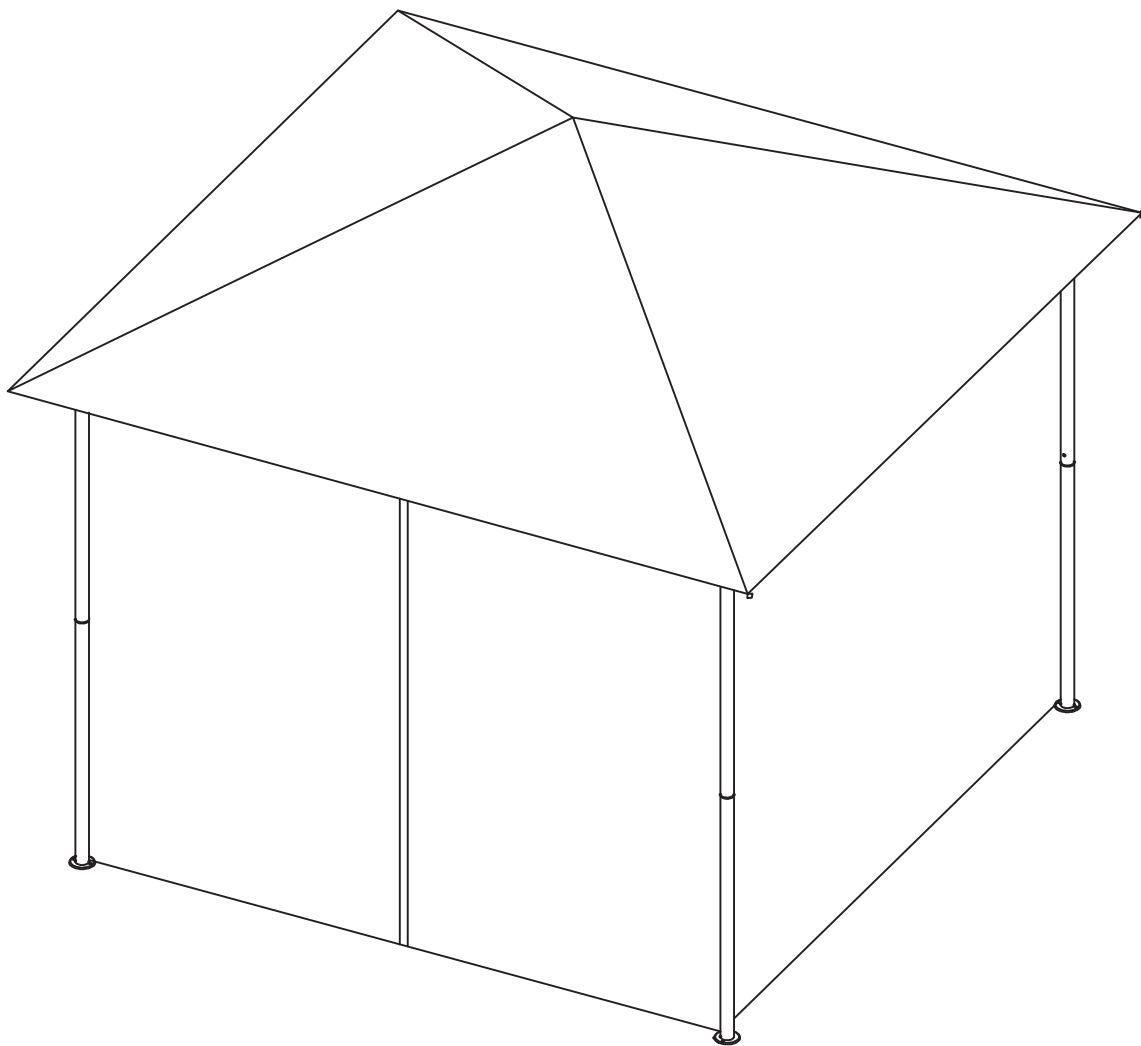

INbae001_CA

84C-239



READ AND SAVE THIS INSTRUCTIONS FOR FUTURE USE











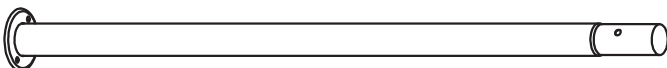
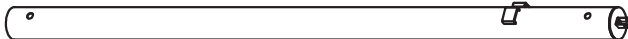

ASSEMBLY & INSTRUCTION MANUAL

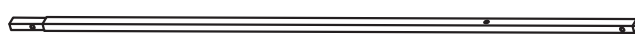
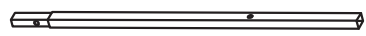
Warning:

1. A 3 person assembly is required for this tent.
2. Please take appropriate actions as heavy rain, wind and snow can damage the tent. If necessary please dis-assemble and store for later use.
3. In snowy conditions please do not allow the thickness of the snow to be more than 5cm on the roof, this should be cleared as soon as possible for your safety.

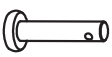
Attention:

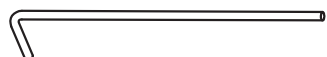
- 1.3 personnes minimum requis pour le montage de la tente.
2. Ne pas utiliser la tente en période de pluie, de vent et de neige qui peuvent endommager la tente. Nous ne serions pas responsable de la mauvaise utilisation du produit.
3. Pour votre sécurité, en période de neige, il est recommandé de ne pas laisser de neige de plus de 5cm sur le toit.

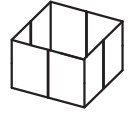
Lower Leg	A1	4	
Upper Leg	A2	4	
Lintel - Right	B1	4	
Lintel - Left	B2	4	
Central Hub	F	1	
Central Bar	H1	8	
Diagonal Bar - Outer	H2	3	
Central Bar - Outer	H3	4	
Diagonal Bar - Adjustable	H4	1	
Knob	M	16	
Netting ring	L	32	
Connect Pin φ5*27	N	8	
Securing wire	O	8	
Stake	S	8	
Top Faric	J	1	
Mesh Screen	K	1	

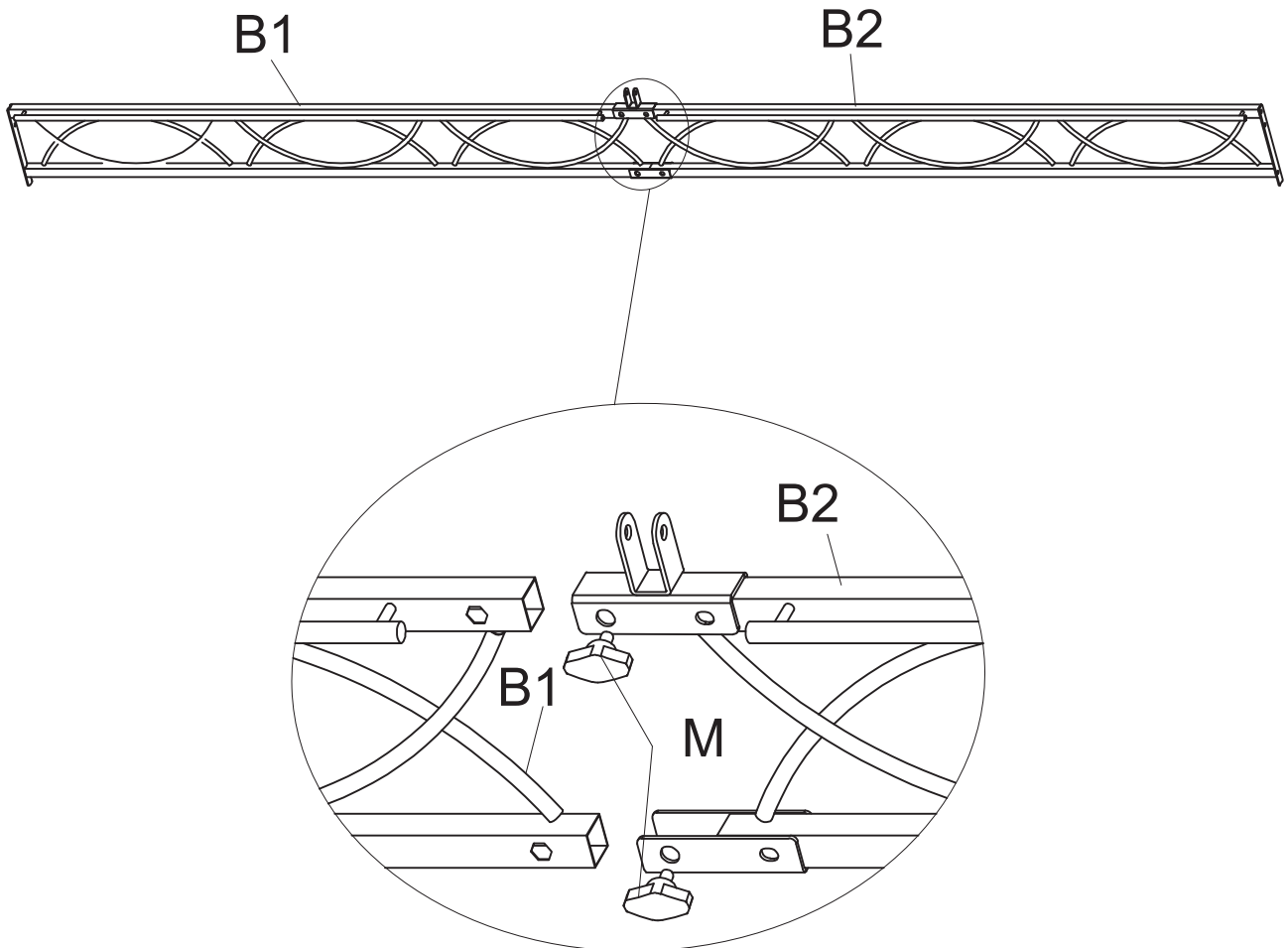

UK: Insert the right-lintel (B1) and left-lintel (B2). Line up all the holes and secure with the knobs (M).

Repeat the above steps for the rest lintels.

FR: Insérez le linteau droit (B1) et le linteau gauche (B2). Aligned tous les trous et fixez-les avec les boutons (M).

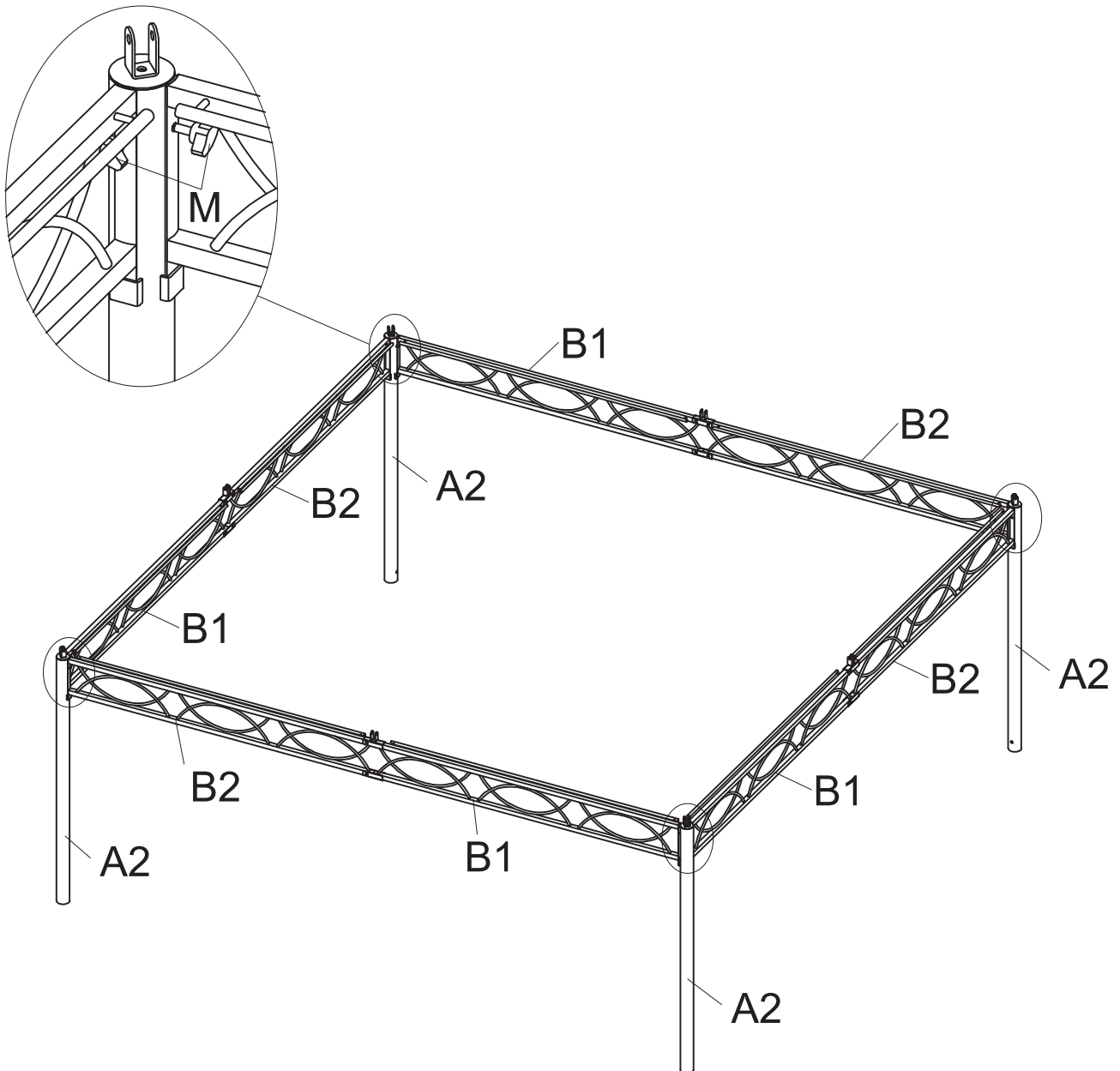

Répétez les étapes ci-dessus pour les autres linteaux.

	M x 8pcs		B2 x 4pcs
	B1 x 4pcs		



UK: Attached the assembled part to the upper legs (A2), secure with the knobs (M).

FR: Fixez la pièce assemblée aux pieds supérieurs (A2), fixez avec les boutons (M).

 <p>A2 x 4pcs</p>	 <p>M x 8pcs</p>
--	---

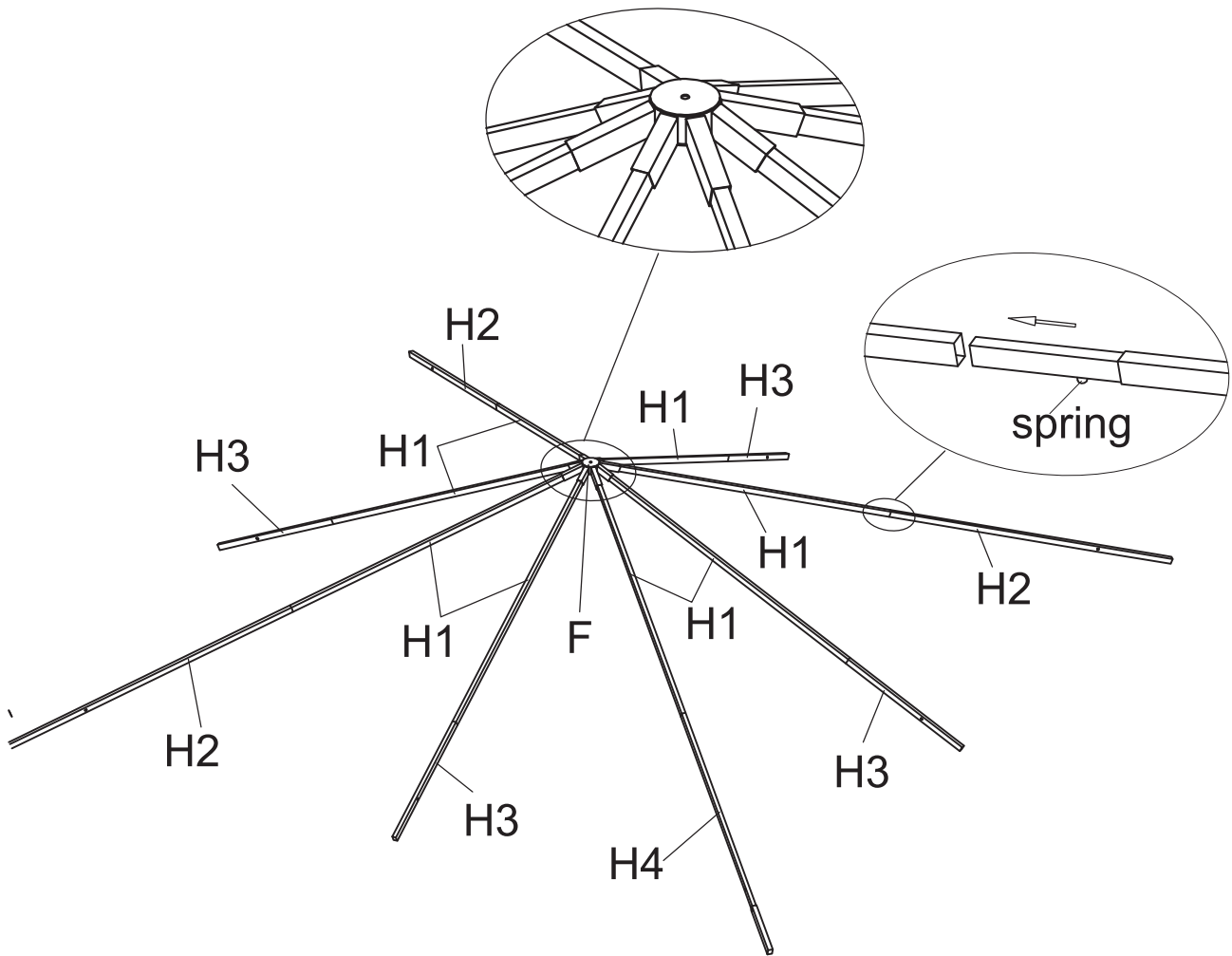

UK: Insert the center bars (H1) to the central hub (F).

Please note : the central hub (F) has 4 short ends and 4 long ends.

Secure the outer central bars (H3) to the center bars (H1), which connects to the 4 short ends.





Secure the outer and adjustable diagonal bars (H2/H4) to the rest center bars (H1) as shown.

FR: Insérez les barres centrales (H1) dans le moyeu central (F).

Remarque: le moyeu central (F) a 4 extrémités courtes et 4 extrémités longues.

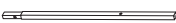
Fixez les barres centrales extérieures (H3) aux barres centrales (H1), qui se connectent aux 4 extrémités courtes.

Fixez les barres diagonales extérieures et réglables (H2 / H4) aux barres centrales de repos (H1) comme illustré.

	H4 x 1pc		H3 x 4pcs
	H2 x 3pcs		H1 x 8pcs
	F x 1pc		

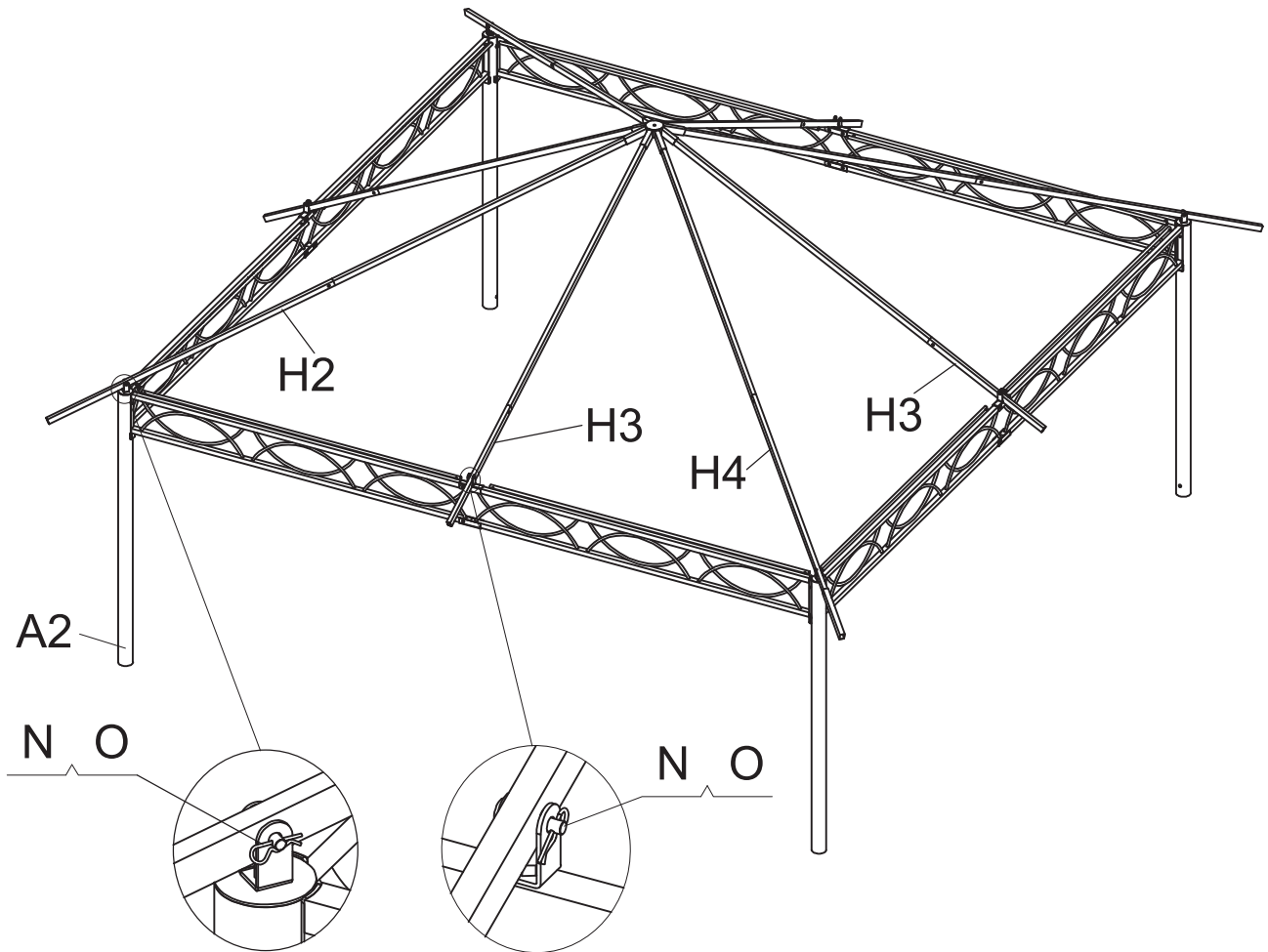

UK: Tighten the U brackets (E) to the upper legs (A2) and the intel (B1/B2), and attach all the top bars (H2/H3/H4) to the Ubrackets (E).

Secure the bars and U brackets with the connectpins (N) and the securing wires (O).

FR: Serrez les supports en U (E) aux pattes supérieures (A2) et à l'intel (B1 / B2), et attachez toutes les barres supérieures (H2 / H3 / H4) aux Ubrackets (E).

Fixez les barres et les supports en U avec les broches de connexion (N) et les fils de fixation (O).

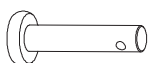

N x 8pcs



O x 8pcs

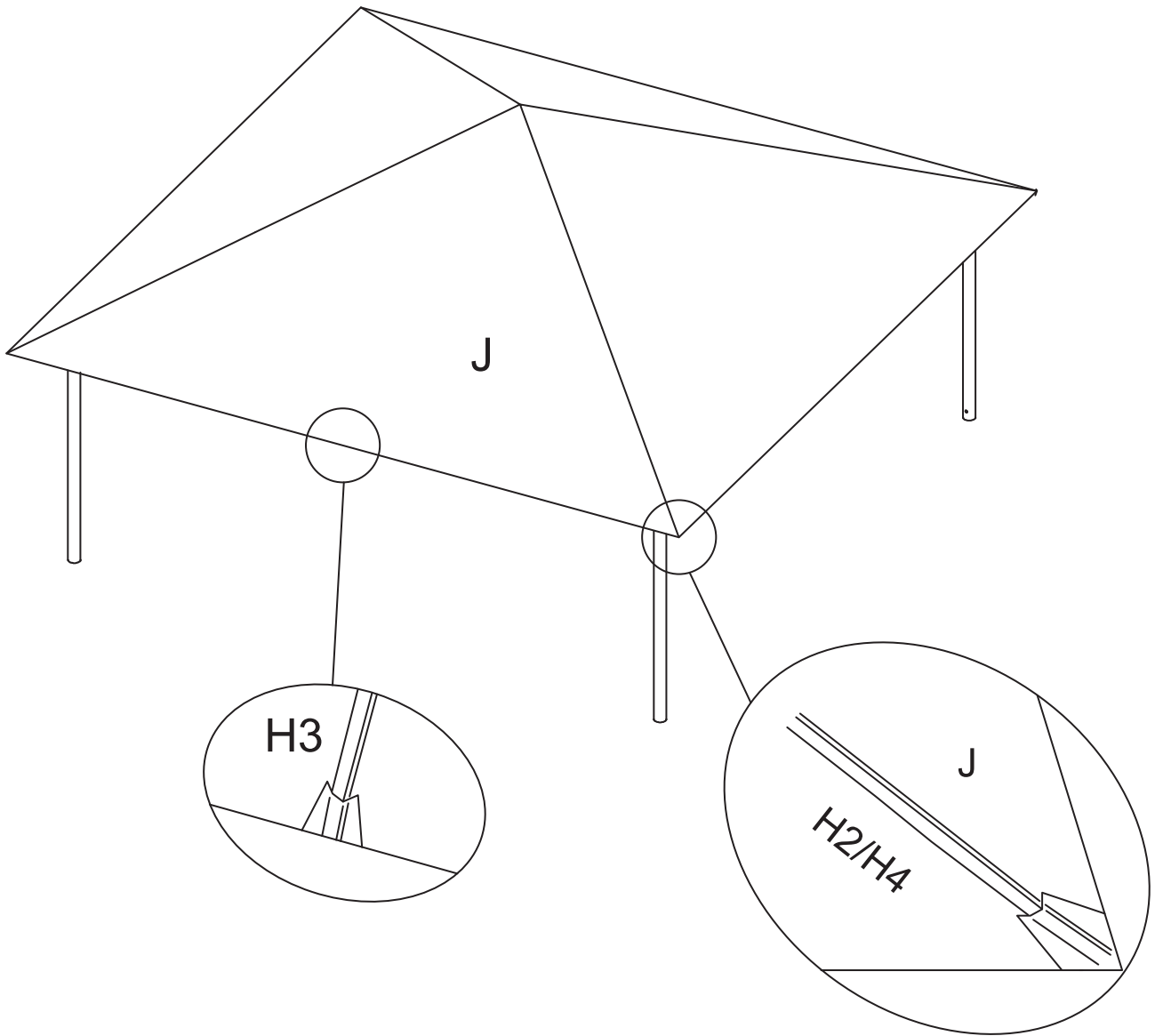

UK: Put the top fabric (J) on the assembled frame like the right diagram. Please ensure the ends of the top bars (H2/H3/H4) are attached into the 8 pockets of the top fabric (J).

FR: Placez le tissu supérieur (J) sur le cadre assemblé comme sur le schéma de droite.

Veillez vous assurer que les extrémités des barres supérieures (H2 / H3 / H4) sont fixées dans les 8 poches du tissu supérieur (J).



J x 1pc

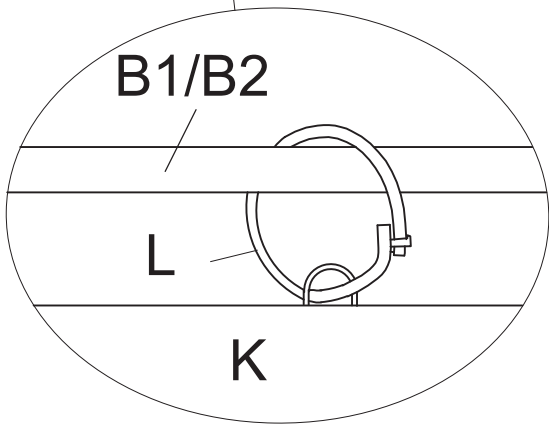
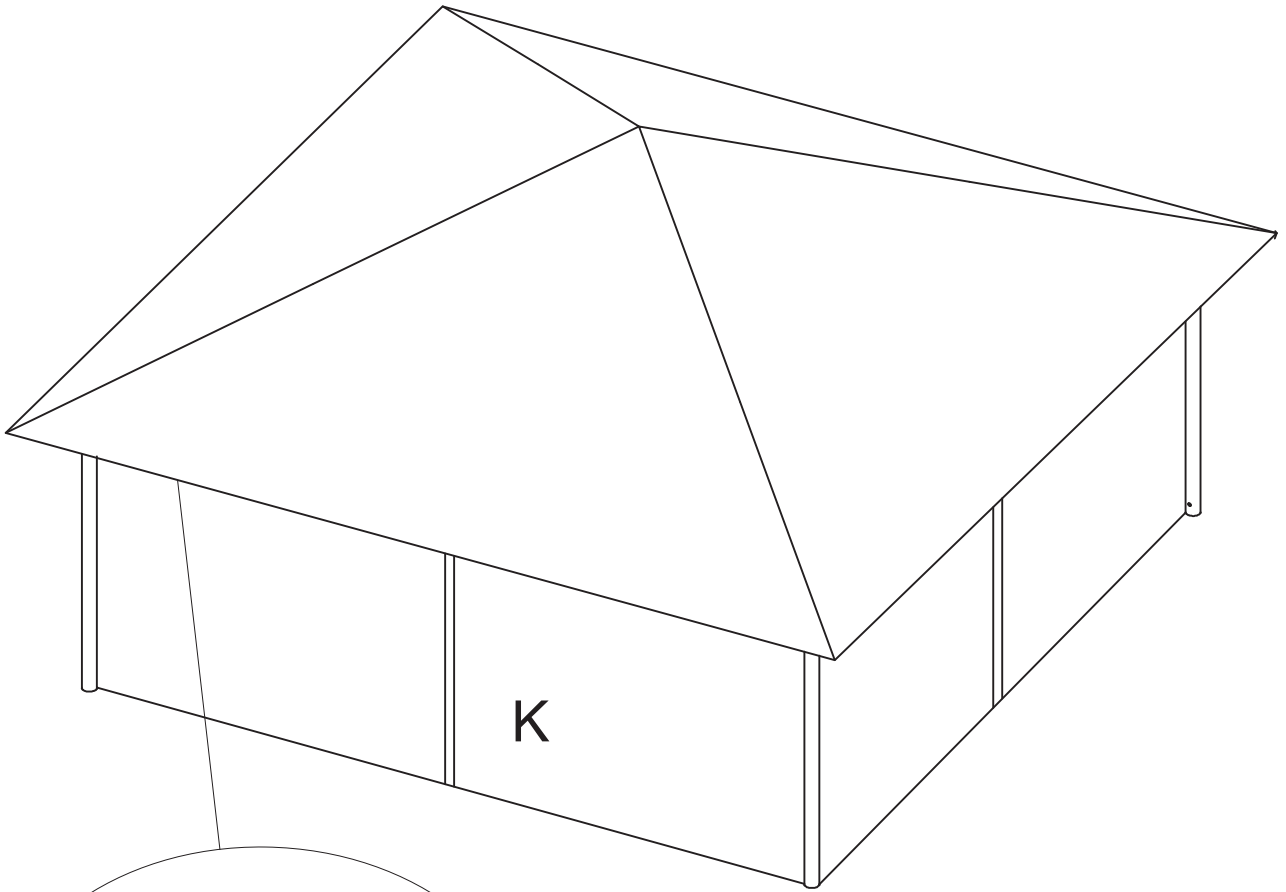

L x 32pcs



K x 1pc

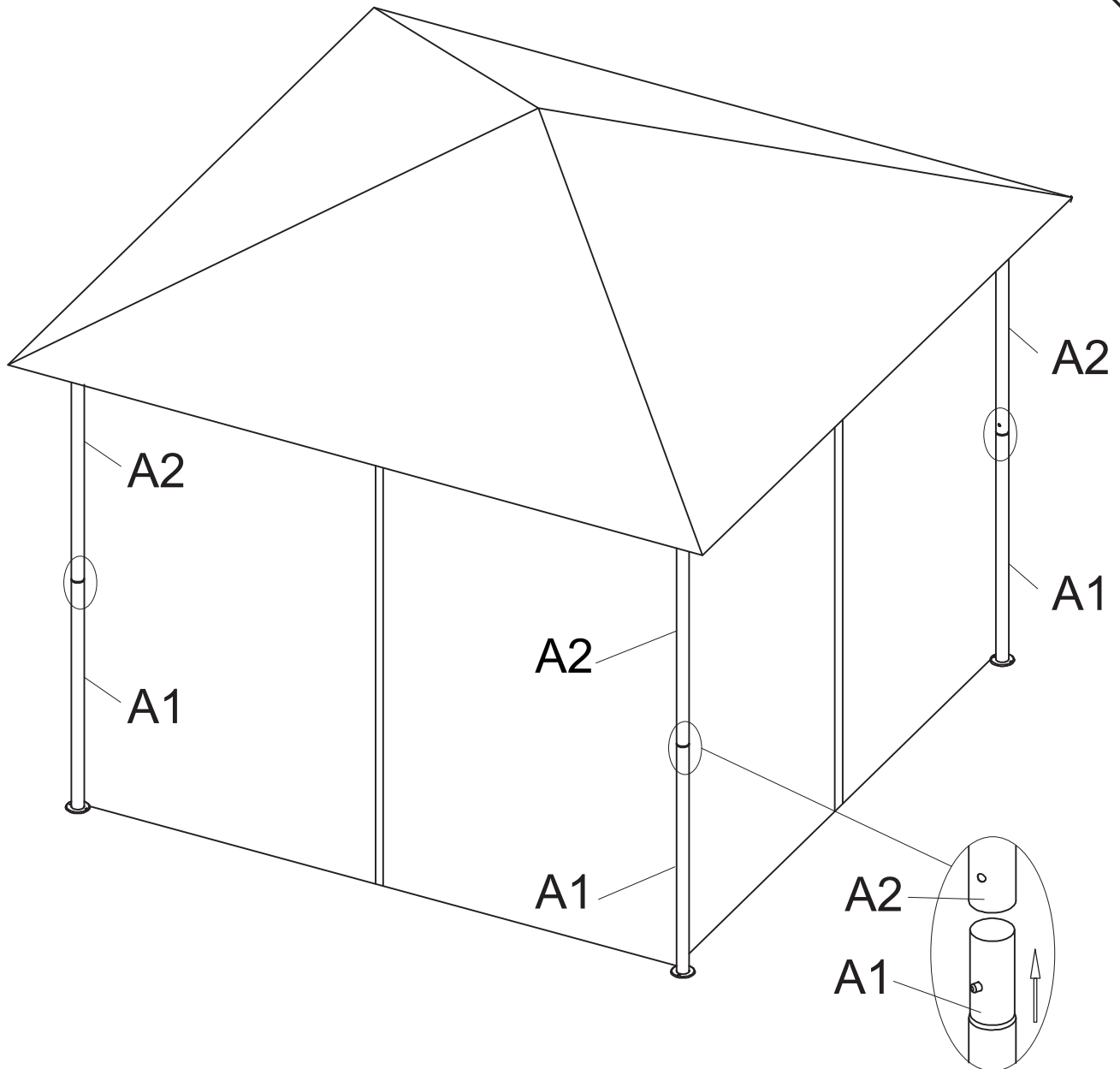

UK: Attach and lock the four lower legs (A1) to the upper legs (A2).

FR: Fixez et verrouillez les quatre pieds inférieurs (A1) aux pieds supérieurs (A2).

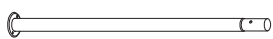

A1 x 4pcs

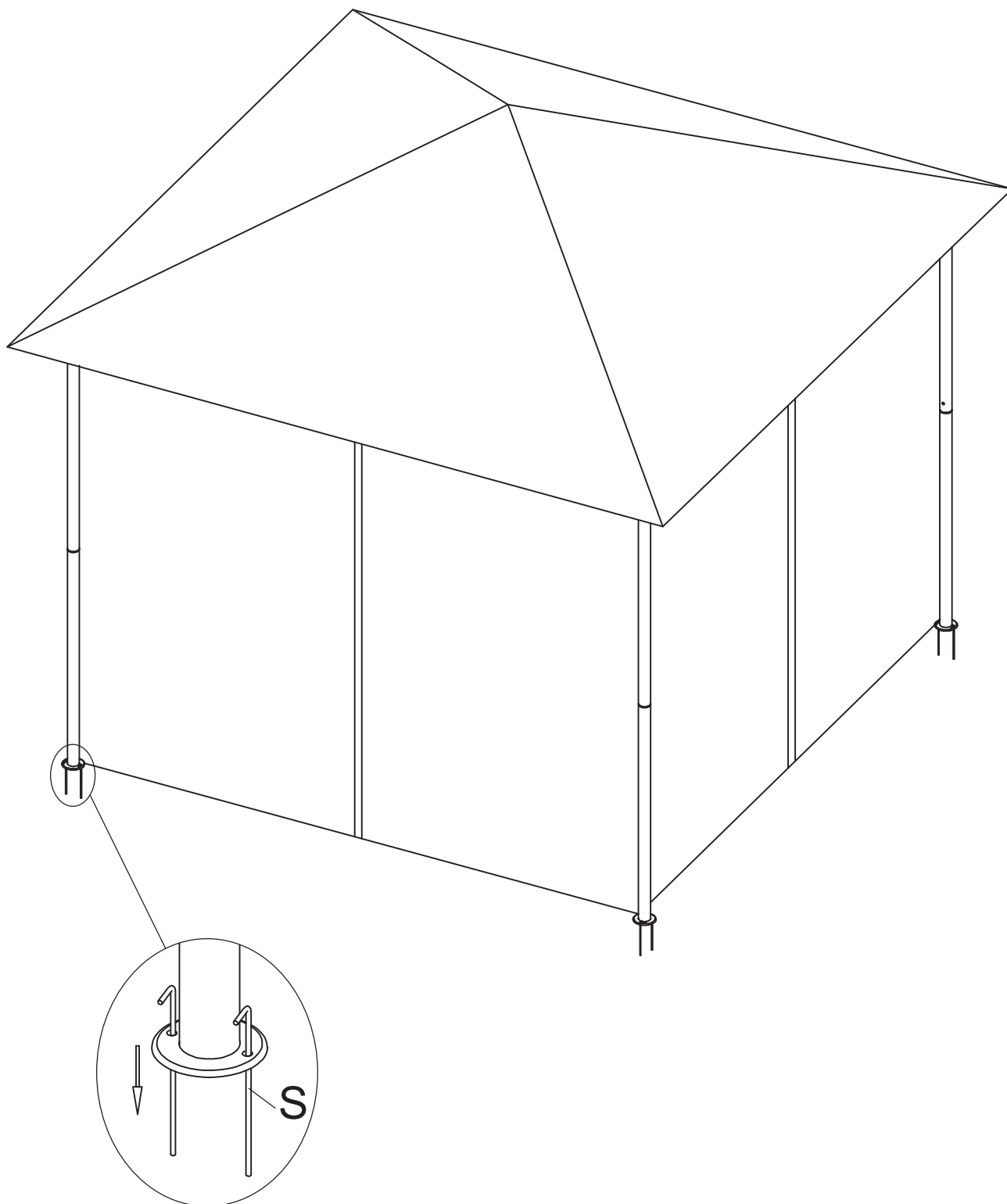

UK: Secure the leg feat with 8 stakes (S).

FR: Fixez l'exploit de jambe avec 8 piquets (S).

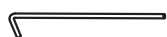

S x 8pcs

US



001-877-644-9366
customerservice@aosom.com

CA



001-855-537-6088
customerservice@aosom.ca

UK



0044-800-240-4004
enquiries@mhstar.co.uk

DE



0049-(0)40-88307530
service@aosom.de

FR



0033-1-84166106
contact@aosom.fr

ES



0034-931294512
atencioncliente@aosom.es

IT



0039-0249471447
clienti@aosom.it