

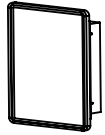



MOUNTING INSTRUCTIONS

This item is meant to be installed in a recess formed within a framed wall construction and is sized to fit between conventional wall stud spacing. Normal installation requires some cutting of the sheetrock wall. If the mounting location interferes with existing studs, moderate re-framing within the wall around the cut opening will be required. To this end, we strongly recommend that this item be installed by a professional, especially if a stud intersects the desired mounting location.

Contents:

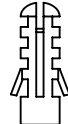
				
Medicine Cabinet X1	Screw X4	Anchor X4	Glass Shelves X3	L-Shaped Clips X12

Tools Needed: Tape Measure, Stud Finder, Philips Screwdriver, Pencil, AND Appropriate cutting tools. Framing tools may be necessary if framing is required.

- 1) Determine the desired mounting location and use a stud finder to locate and mark the studs in the area. This cabinet is sized to fit between studs and hopefully the installer takes this into account when deciding on the mounting location. However, in some instances, a wall stud may end up intersecting the mounting location. In such instance, the intersecting stud will have to be cut and a frame will have to be installed around the cutout into which the cabinet will be installed. Owing to the relative complexity of framing within a wall, we recommend that a professional be hired to install this item should any framing be required. Regardless, this cabinet is designed to be secured along the inside side walls so a stud must be positioned immediately adjacent to the sides of the cabinet.
- 2) Use appropriate tools to carefully cut into the wall material between two wall studs a vertical rectangle measuring 14.25 inches wide and 21.77 inches in height. If you cannot position the item between adjacent studs, then use appropriate tools to frame this opening so that firmly installed studs are positioned immediately adjacent to the sides of the inserted portion of the cabinet, when the cabinet is inserted within the framed section. Re-sheetrock, spackle and tape and paint the area as needed so that only the framed cutout remains.
- 3) Use appropriate tools to carefully cut into the wall material between two wall studs a vertical rectangle measuring 14.25 inches wide and 21.77 inches in height. If you cannot position the item between adjacent studs, then use appropriate tools to frame this opening so that firmly installed studs are positioned immediately adjacent to the sides of the inserted portion of the cabinet, when the cabinet is inserted within the framed section. Re-sheetrock, spackle and tape and paint the area as needed so that only the framed cutout remains.
- 4) Use the provided screws and a screwdriver to secure the cabinet to the adjacent side wall studs – two screws on each side. Use the provided two screw-holes located along the side walls inside the cabinet. **DO NOT OVERTIGHTEN THESE SCREWS** – doing so can deform the cabinet. Installation is now complete.

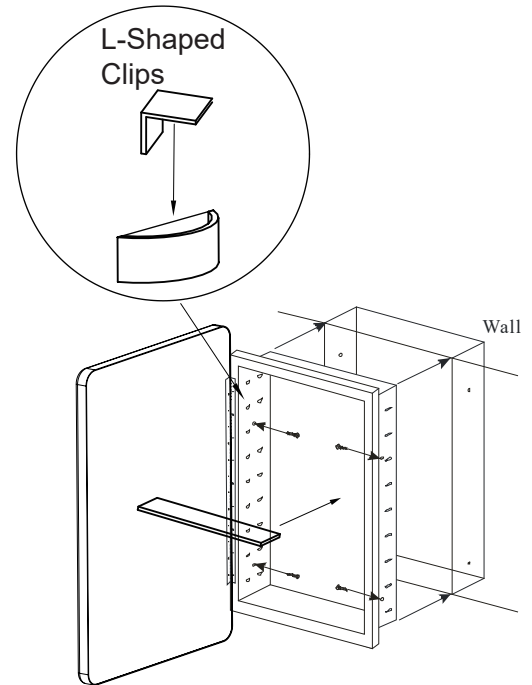
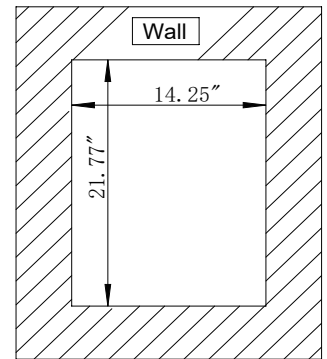

Install the Shelves: For each shelf, insert four L-shaped clips into four slots that are provided along the inside walls of the cabinet.

Care Instructions: Wipe with a soft, dry cloth. To protect the finish, do not use household cleaners or abrasives.



Missing Hardware: The parts are been carefully packed within a red bag and inserted in the styrofoam. Please check again in case you do not find the parts. If your order indeed arrives missing hardware, please do not worry, and feel free to reach out to us for help, we will ship you the replacement ASAP.