

# Assembly Instructions

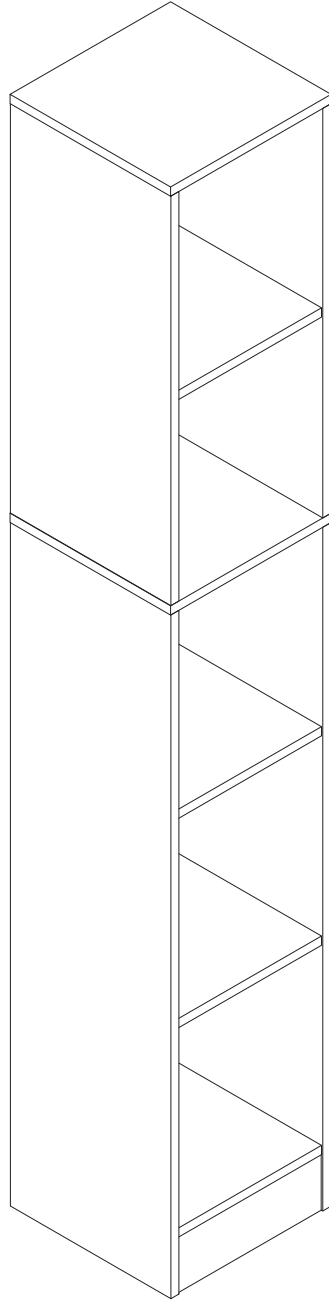

---

**Bookshelf**

Model No.  
**HOGA-HL0344**

---

# Contact Us

## We're here to help you.

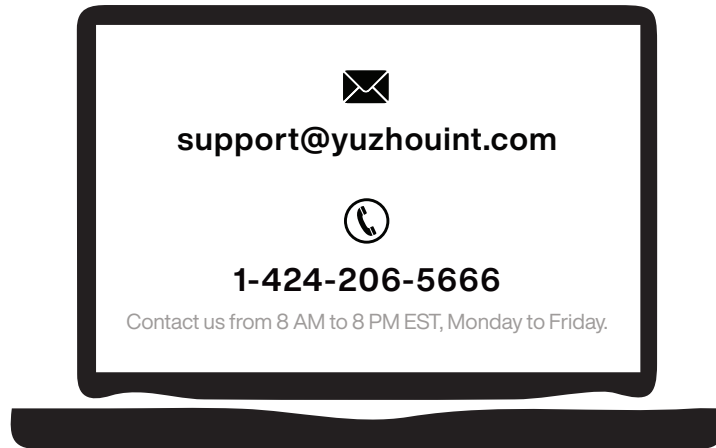

Your satisfaction is our top priority. If you encounter any issues with this product, such as missing or damaged parts, we're here to help. Please retain the original packaging and take photos of the packaging and the product, then contact us as soon as possible.

### Warm Tips

1. Carefully read these instructions and keep them for future reference.
2. Check the parts list and confirm everything's there before starting assembly.
3. When assembling, put all parts on a soft, smooth surface like a carpet to avoid scratches.
4. Don't fully tighten screws until all parts are confirmed in place to avoid misalignment.

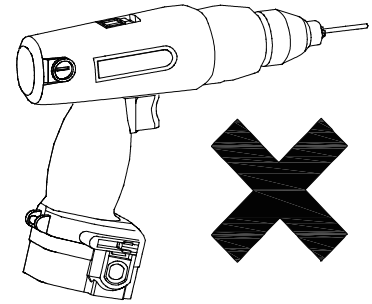
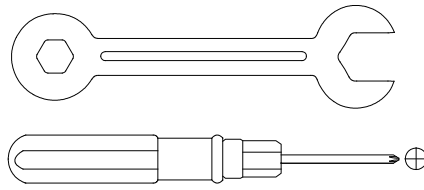
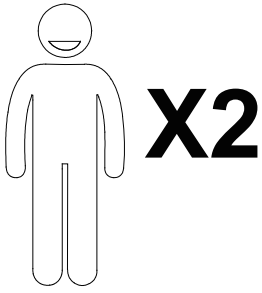

We recommend using hand tools for assembly.

If an electric screwdriver is used, reduce power and torque to avoid damage to the product.

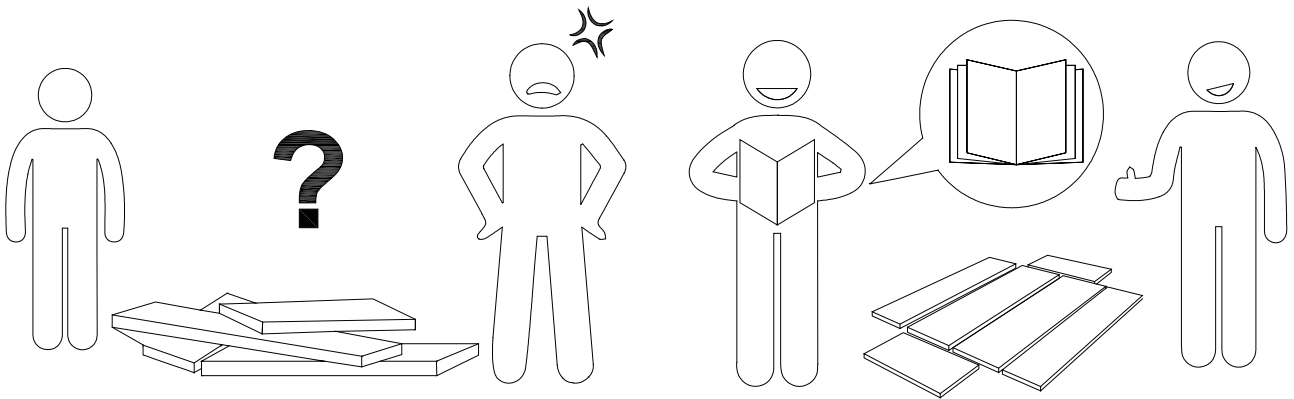

## Install the Anti-Tip Straps

Using the anti-tip straps can reduce the risk of tipping over, but can not eliminate it.

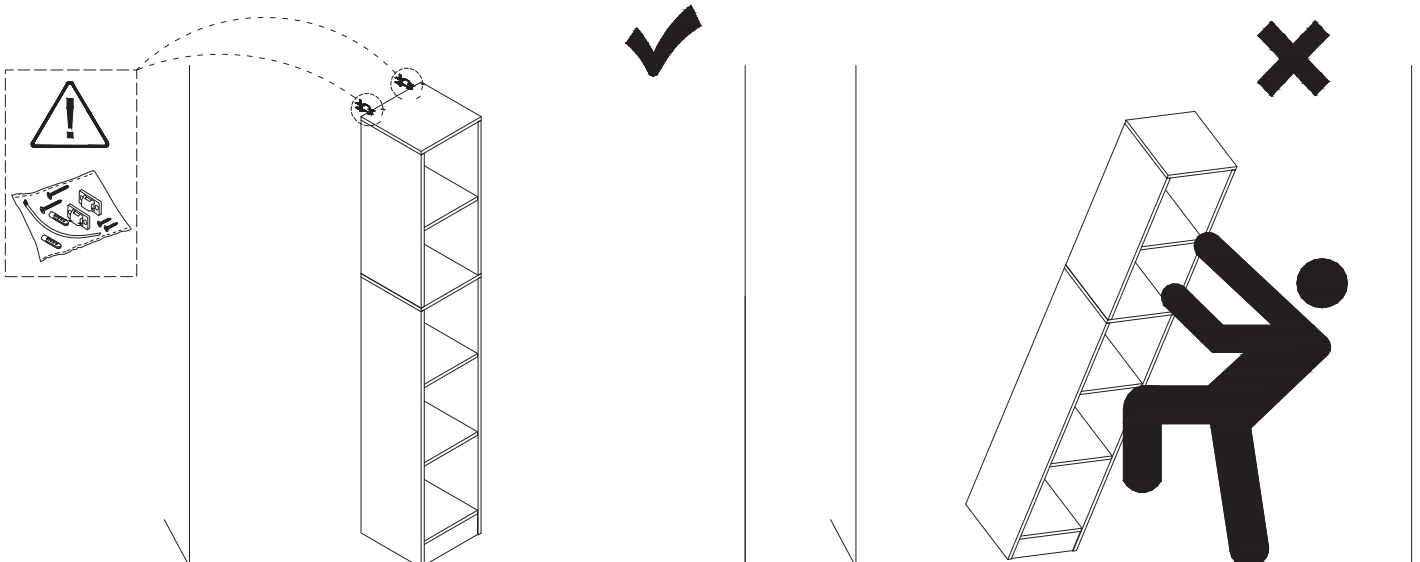

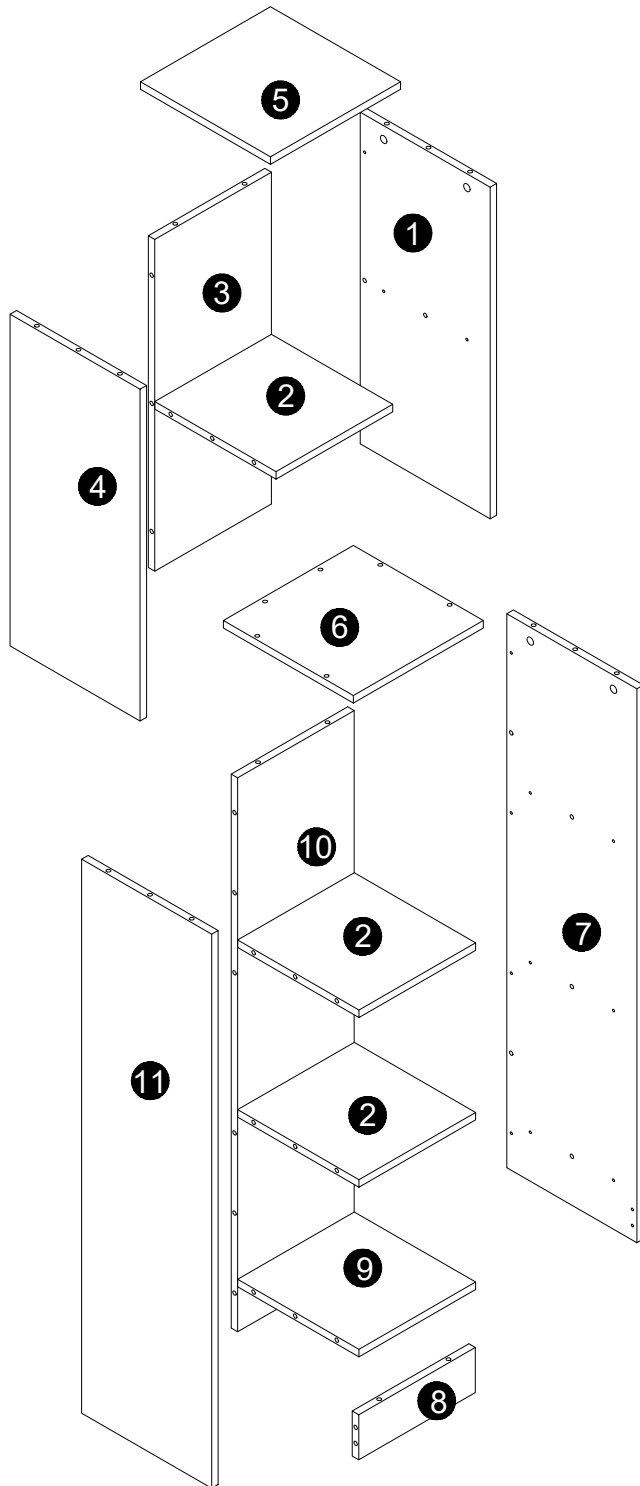



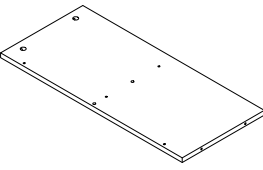
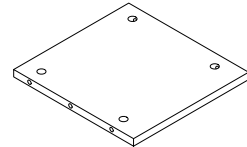
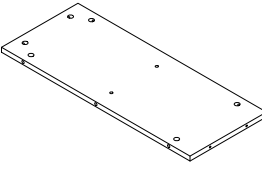
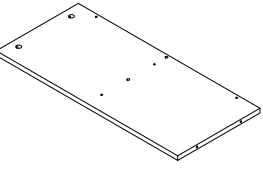
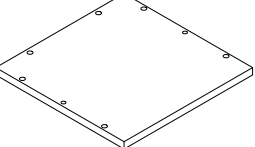
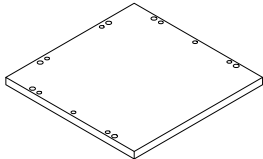
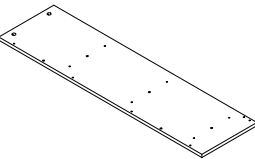
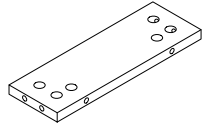
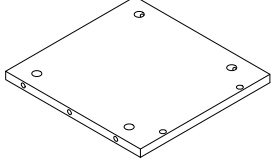
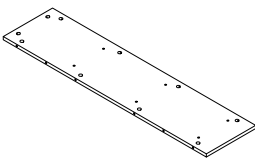
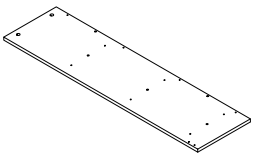

**⚠ Caution**

Make sure all parts are included. Most board parts are labeled or stamped on the raw edge. Contact us for a free replacement if you encounter any damaged or missing parts.

# Parts List

<p><b>1</b></p>  <p>1pc</p>	<p><b>2</b></p>  <p>3 pcs</p>	<p><b>3</b></p>  <p>1pc</p>	<p><b>4</b></p>  <p>1pc</p>	<p><b>5</b></p>  <p>1pc</p>
<p><b>6</b></p>  <p>1pc</p>	<p><b>7</b></p>  <p>1pc</p>	<p><b>8</b></p>  <p>1pc</p>	<p><b>9</b></p>  <p>1pc</p>	<p><b>10</b></p>  <p>1pc</p>
<p><b>11</b></p>  <p>1pc</p>				

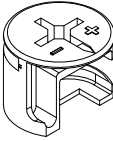
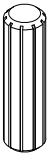
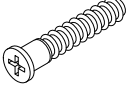
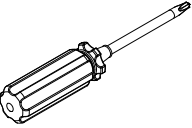
# Hardware List

A	B	C	D	E	F
 M6x35mm	 Ø15x12mm	 Ø8x30mm	 Ø7x38mm	 Screwdriver	 2 pcs
46 pcs	46 pcs	18 pcs	14 pcs	1 pc	2 pcs
G					
 M10x3mm					
8 pcs					

# Installation of Cams and Pins

Read each step carefully before starting. Each step of instruction should be performed in the correct order. If these steps are not followed in sequence, assembly difficulties may occur.

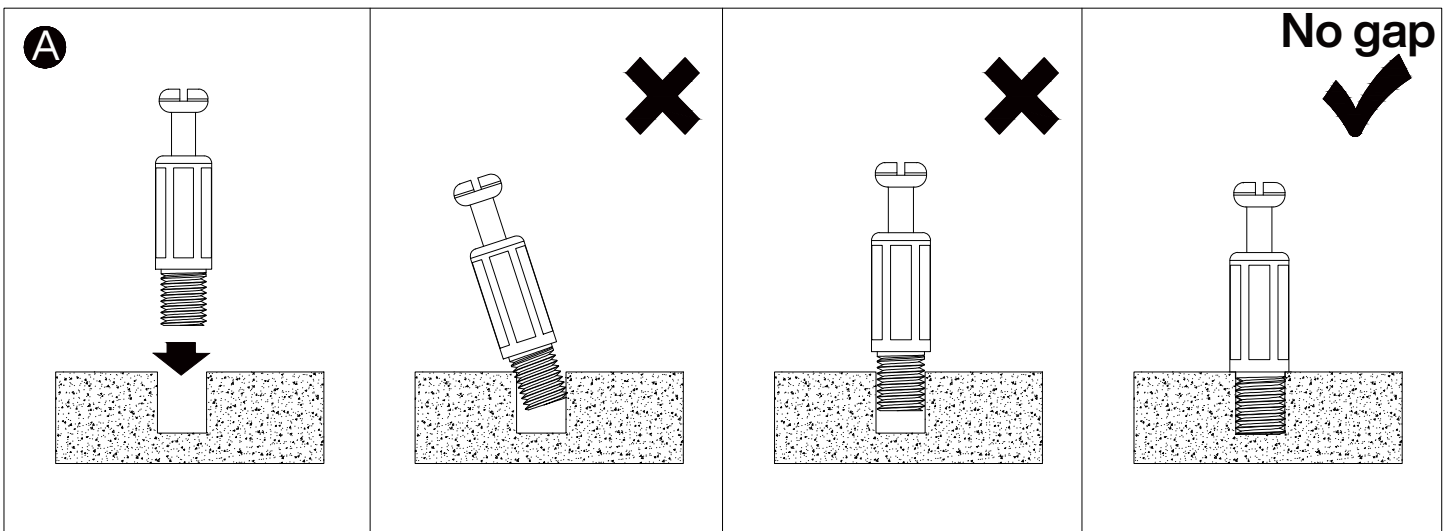
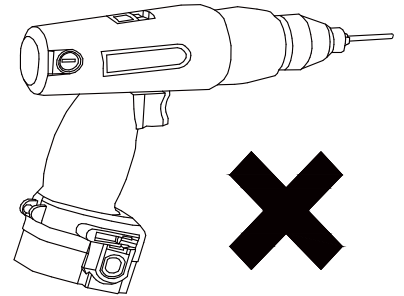

Screw the pin into the hole. Set the cams correctly by aligning the head of the cams with the lock pins. Lock the cam by turning the cam head with a screwdriver until it is tightened. Please do not use an electric screwdriver to assemble the unit.

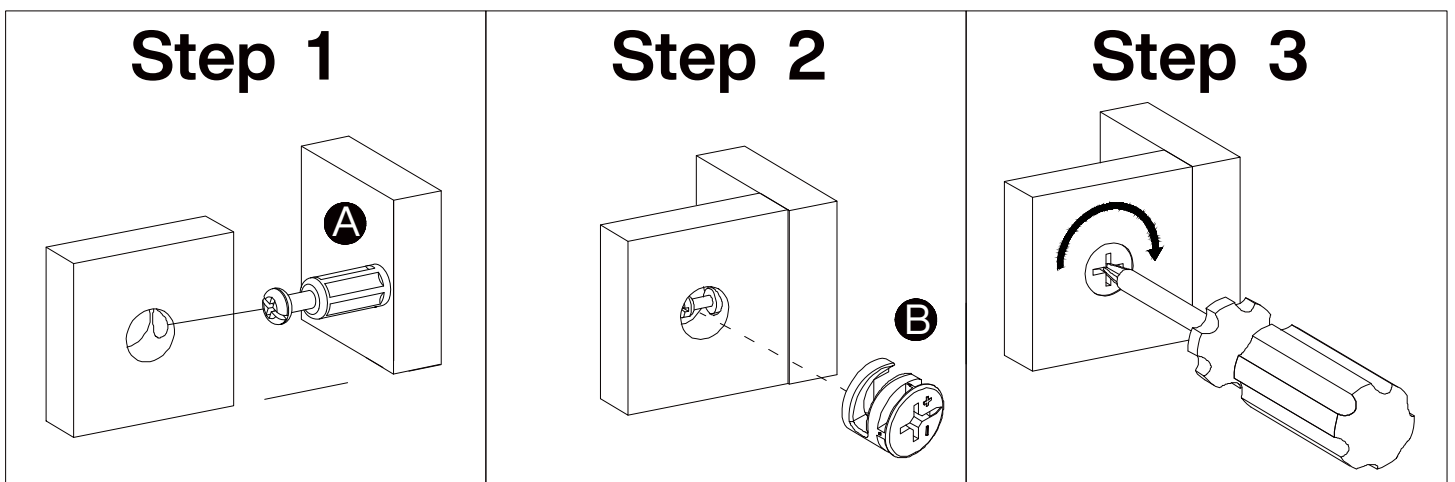

1

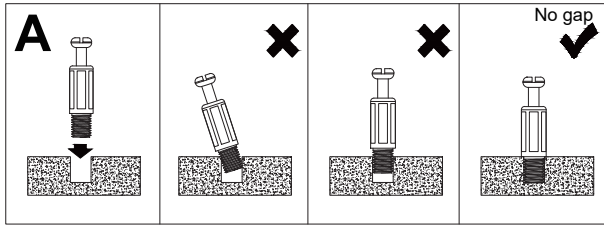

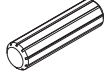
A	C
	
M6x35mm	Ø10x30mm
8 pcs	4 pcs

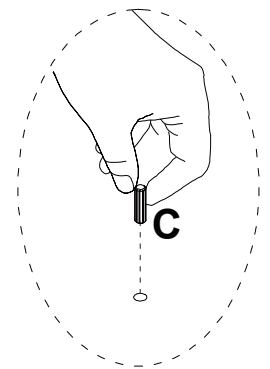
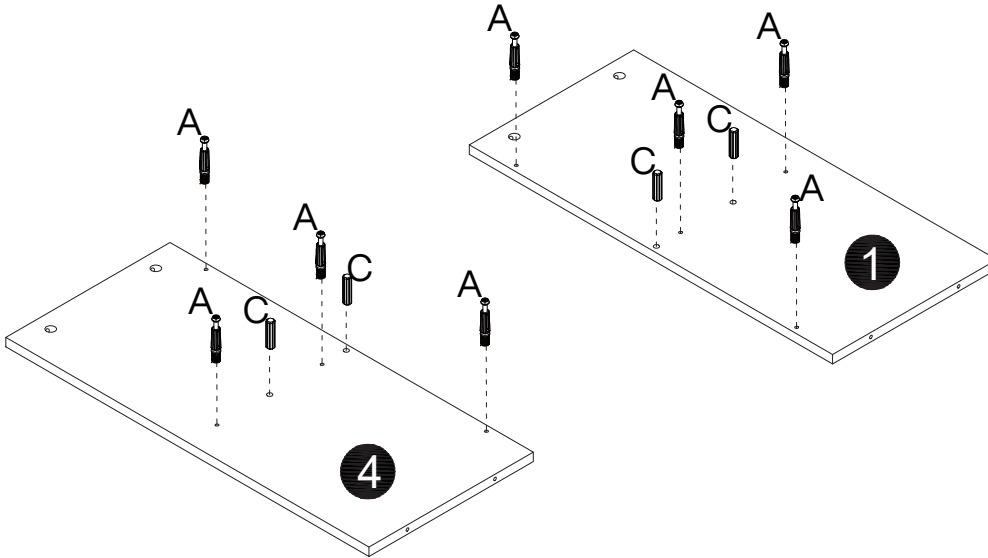

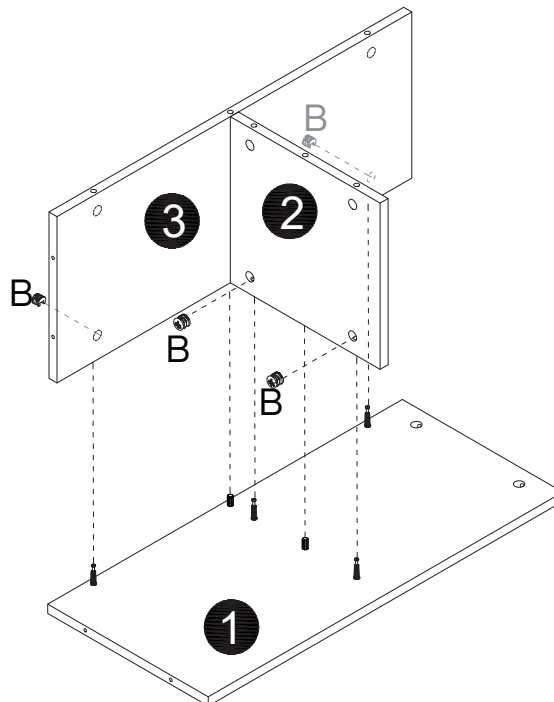
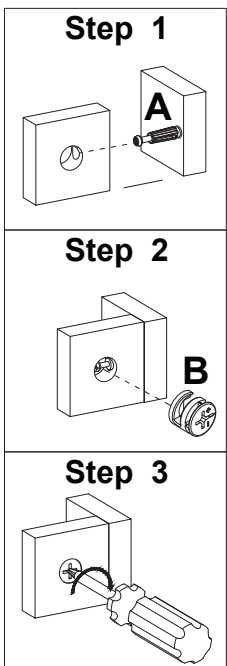

2

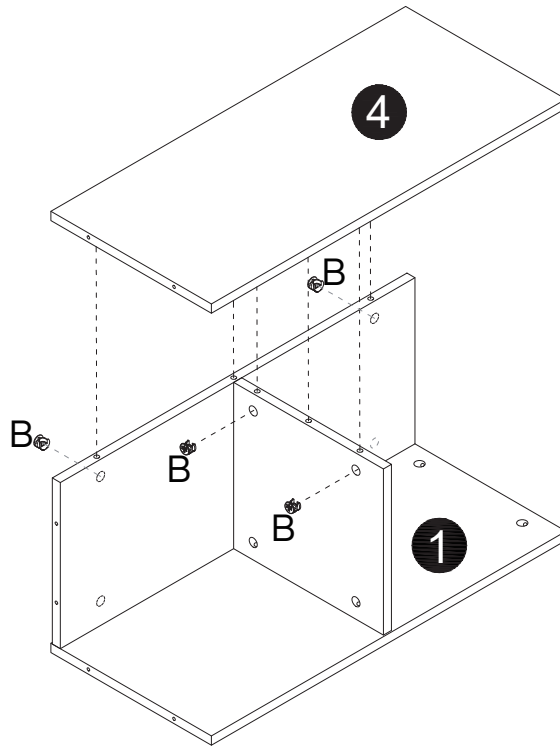
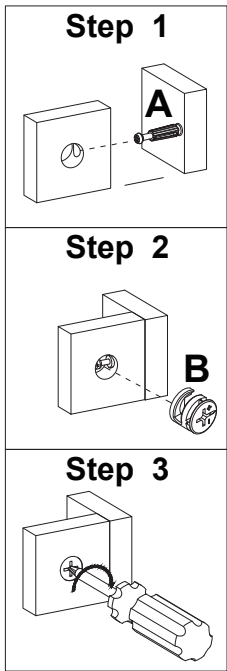

B

Ø15x12mm
4 pcs

# 3

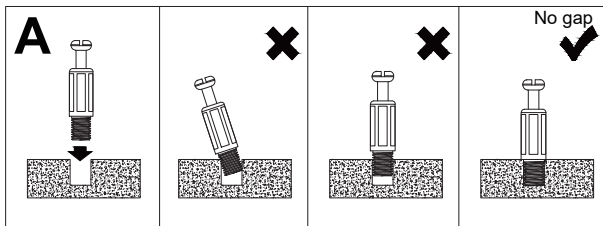

<b>B</b>

Ø15x12mm 4 pcs

# 4

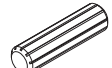

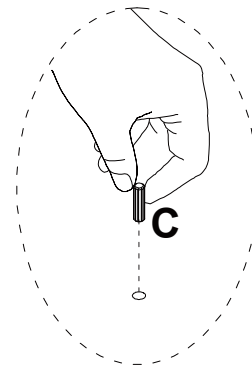
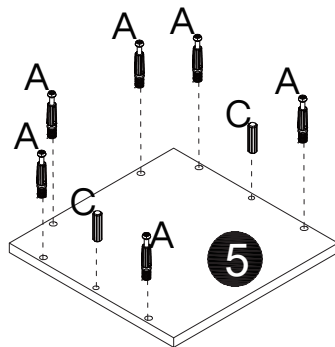
<b>A</b>	<b>C</b>
	
M6x35mm 6 pcs	Ø10x30mm 2 pcs



# 5

<b>B</b>

Ø15x12mm 6 pcs

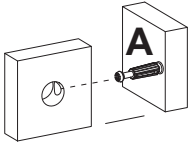
**Step 1**

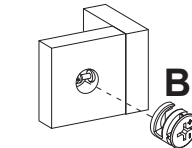

**Step 2**

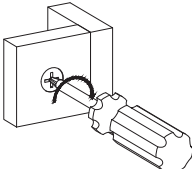
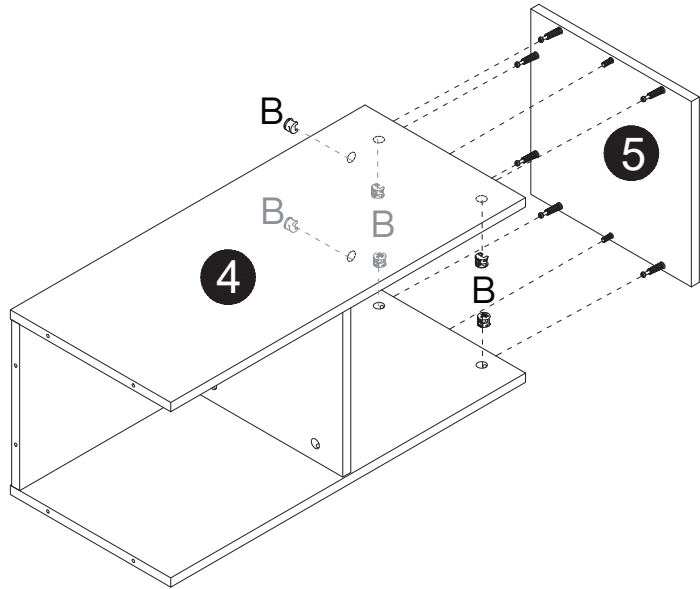

**Step 3**

# 6

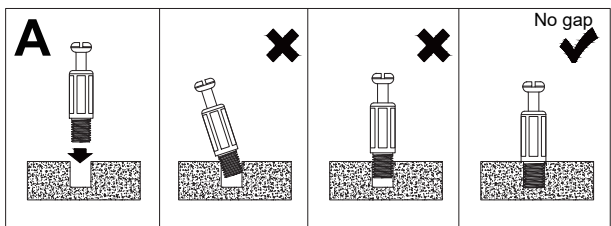

<b>A</b>	<b>C</b>
	
M6x35mm 6 pcs	Ø10x30mm 2 pcs

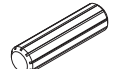

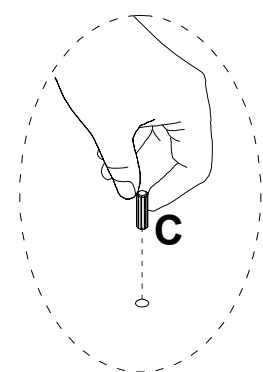
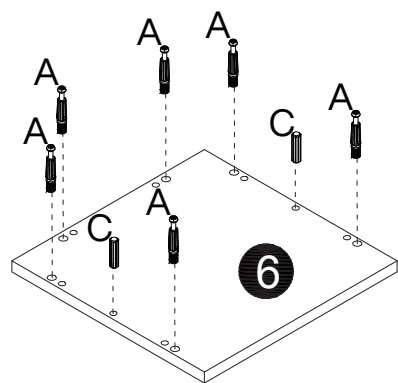
7

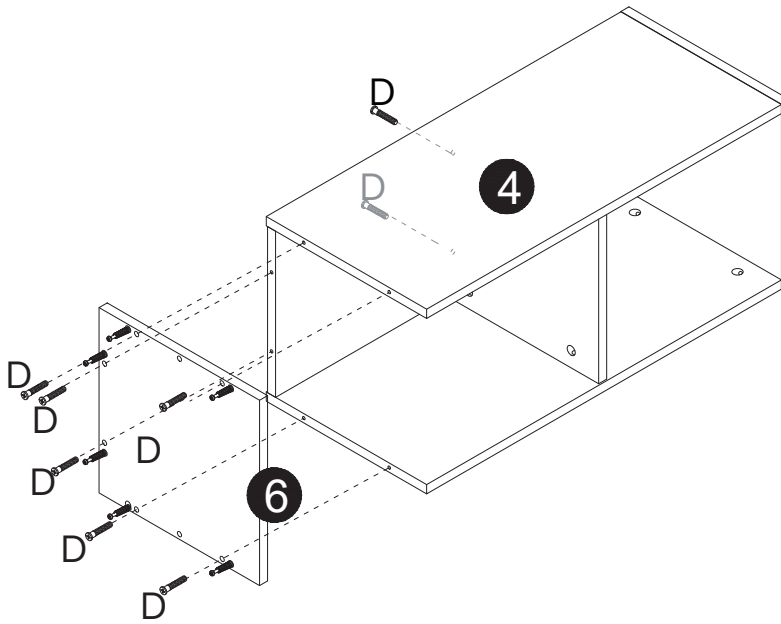

<b>D</b>

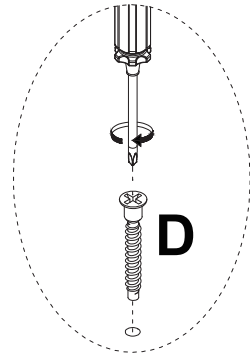
Ø7x38mm 8 pcs

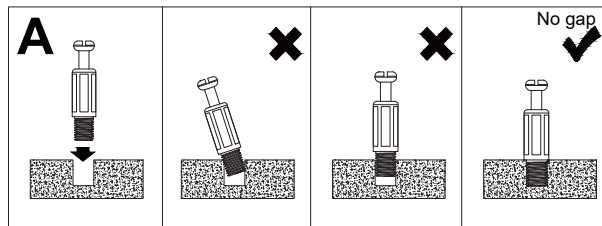

8

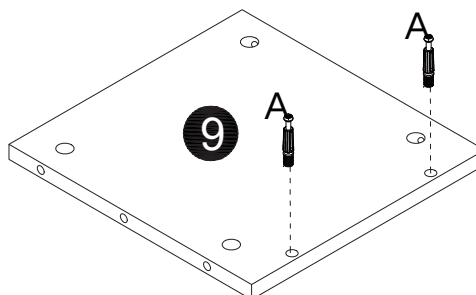

<b>A</b>

M6x35mm 2 pcs



# 9

<b>B</b>

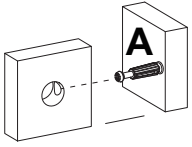
Ø15x12mm 2 pcs

**Step 1**

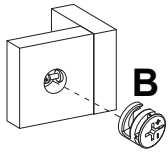

**Step 2**

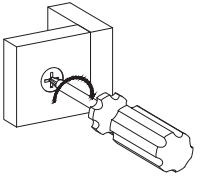
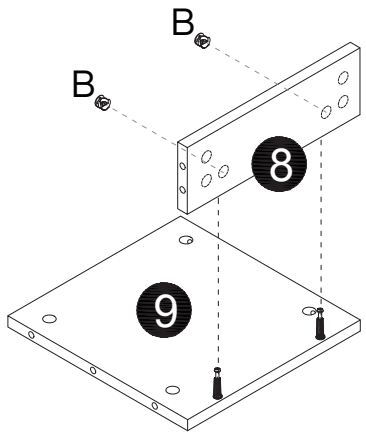

**Step 3**

# 10

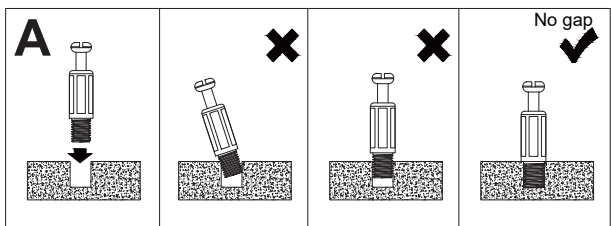

<b>A</b>	<b>C</b>
	
M6x35mm 24 pcs	Ø8x30mm 10 pcs

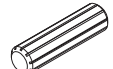

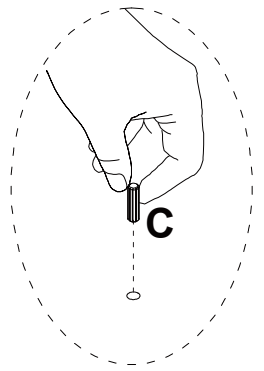
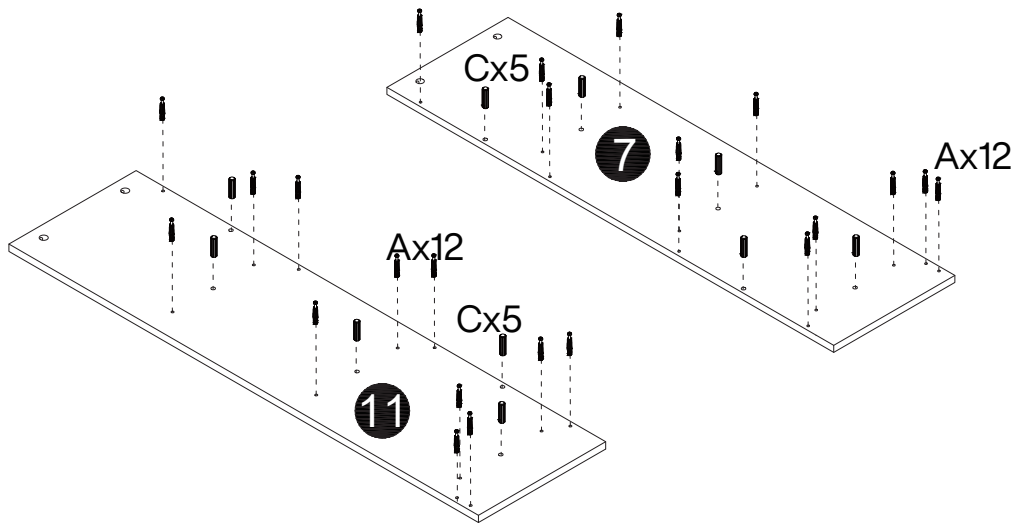
# 11

<b>B</b>

Ø15x12mm
12 pcs

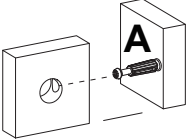
**Step 1**

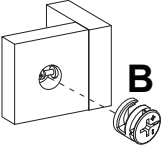

**Step 2**

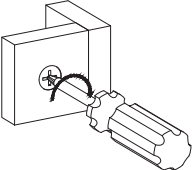
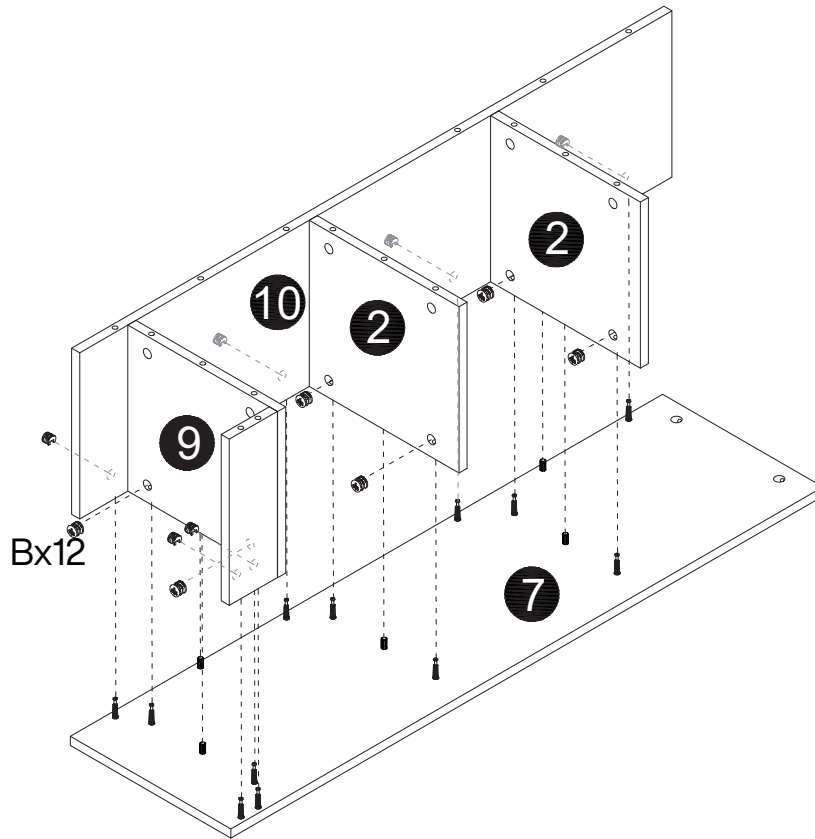

**Step 3**

# 12

<b>B</b>

Ø15x12mm
12 pcs

**Step 1**

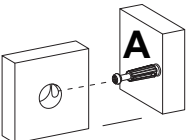

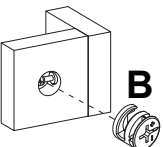
**Step 2**



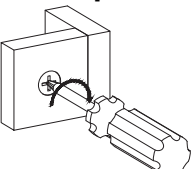
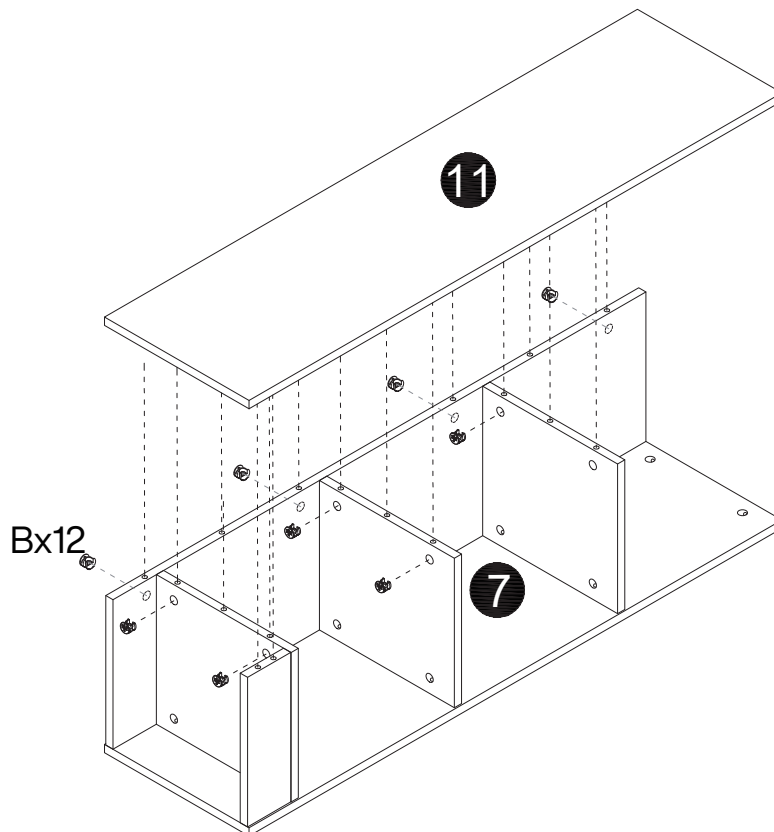

**Step 3**

**13**

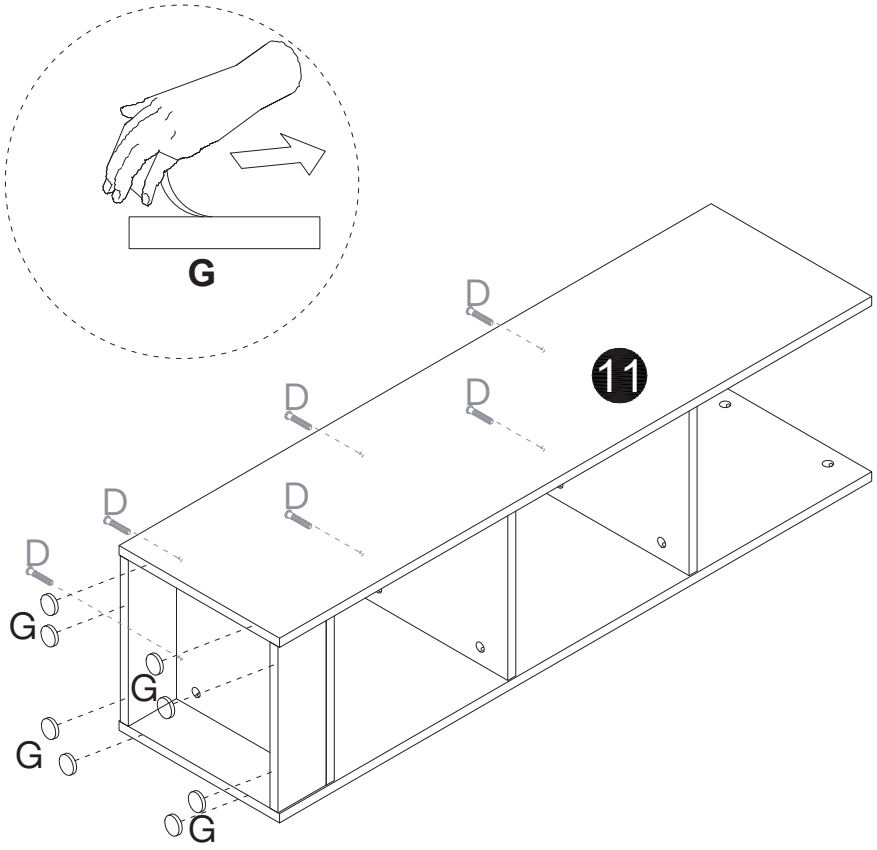

D	G
	
Ø7x38mm 6 pcs	M10x3mm 8 pcs

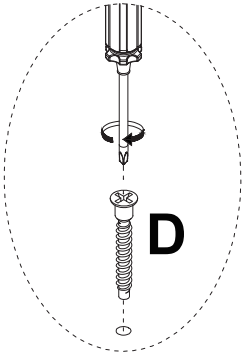

**14**

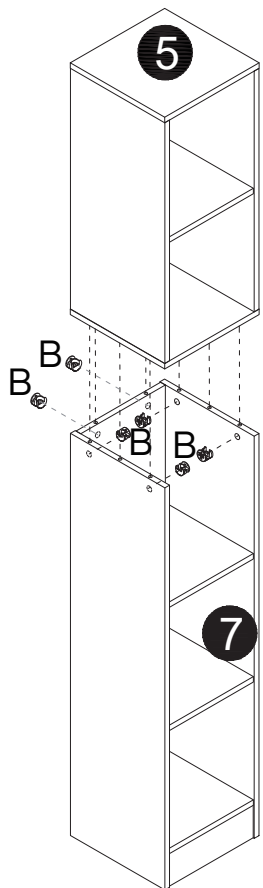
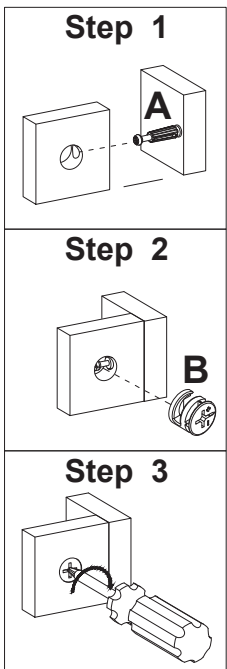

B

Ø15x12mm 6 pcs

15

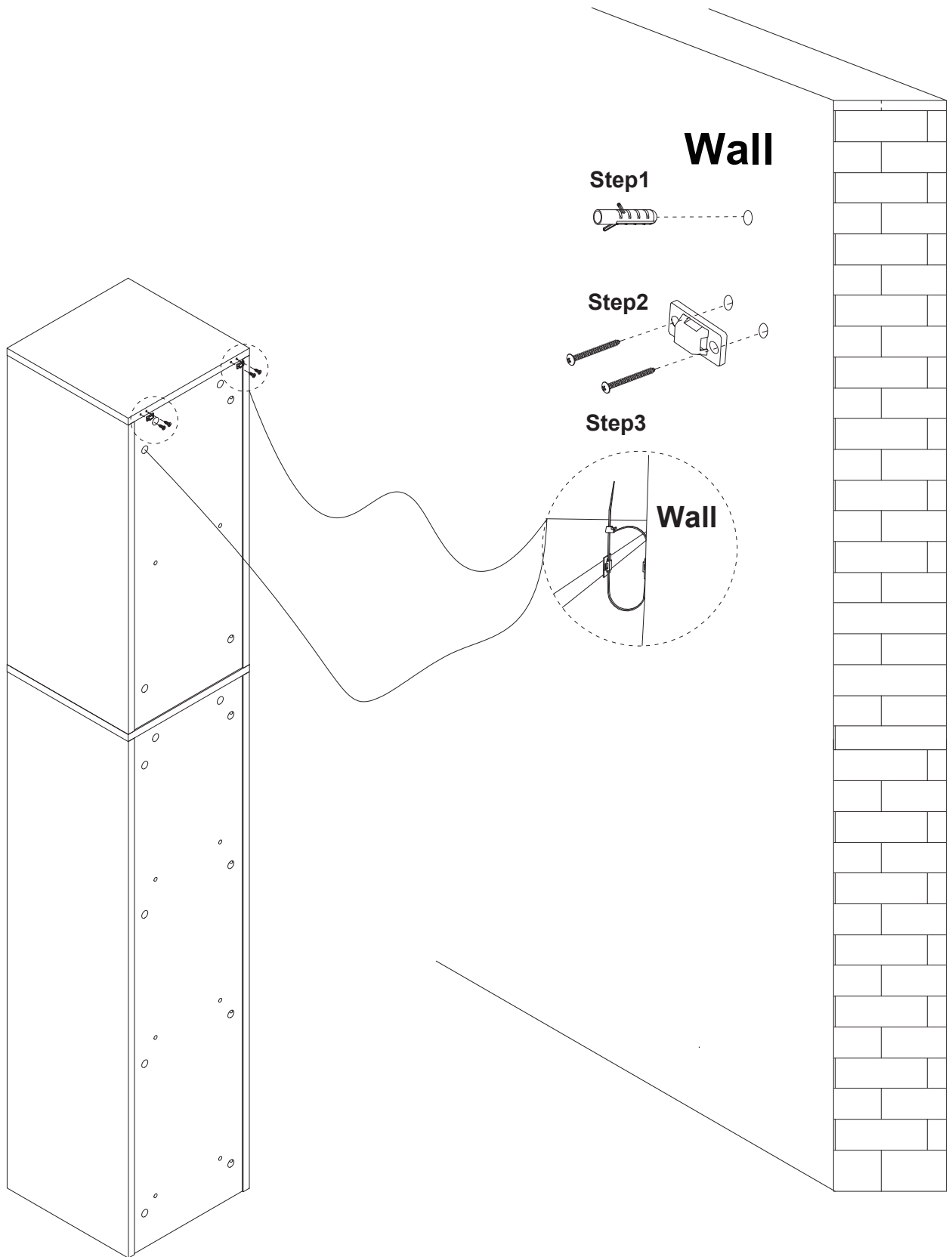
<b>F</b>

2 pcs



**Thank you for your support!**

