



8-DRAWER STORAGE CHEST
AUFBEWAHRUNGSKOMMODE MIT 8 SCHUBLADEN
ARMOIRE DE RANGEMENT AVEC 8 TIROIRS
8-CASSETTO PORTAGGETTI
CÓMODA DE 8 CAJONES



Attention: Do not tighten the screws until you have completed the assembly.

1. Please be aware that the drawer storage towers are lightweight, so pulling them down could be dangerous, especially when children are playing and chasing each other around the drawers.

2. Professional installation is highly recommended.

Achtung: Ziehen Sie die Schrauben erst an, wenn Sie den Aufbau abgeschlossen haben.

1. Bitte beachten Sie, dass die Lagertürme mit Schubladen sehr leicht sind, so dass sie einfach heruntergezogen werden können, wodurch Gefahren verursacht werden, insbesondere wenn Kinder damit spielen und sich herumjagen.

2. Ein fachgerechter Einbau wird dringend empfohlen.

Remarque: Ne serrez pas les vis avant d'avoir terminé l'assemblage.

1. Veuillez noter que les tours de rangement des tiroirs sont légères, il peut donc être dangereux de les abaisser, surtout lorsque les enfants jouent et se poursuivent autour des tiroirs.

2. Une installation professionnelle est fortement recommandée.

Attenzione: Non serrare le viti fino a quando non si è completato il montaggio dell'installazione.

1. Tenere presente che le torri di stoccaggio dei cassetti sono leggere, quindi tirarle verso il basso potrebbe essere pericoloso, specialmente quando i bambini giocano e si rincorrono intorno ai cassetti.

2. Si consiglia vivamente un'installazione professionale.



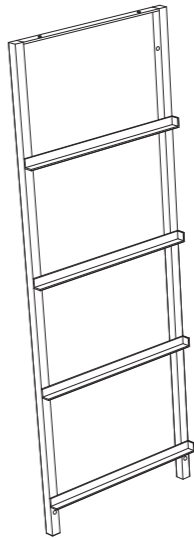
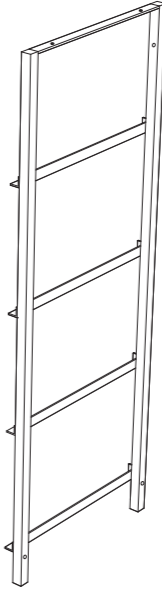

Atención: No apriete los tornillos hasta que haya completado el montaje de la configuración.

1. Tenga en cuenta que las torres de cajones son ligeras, por lo que puede ser peligroso bajarlas, especialmente cuando los niños juegan y persiguen alrededor de los cajones.

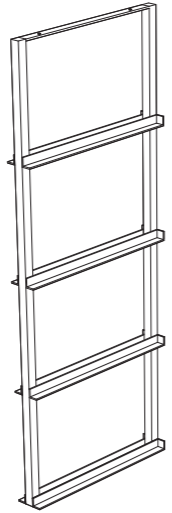
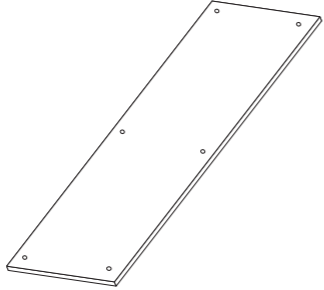
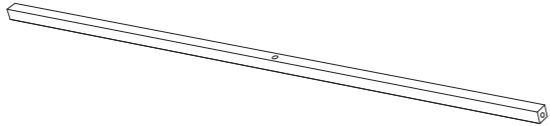
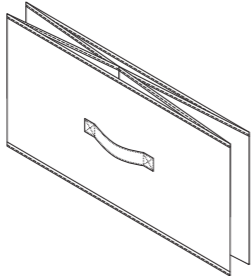
2. Se recomienda encarecidamente la instalación profesional.

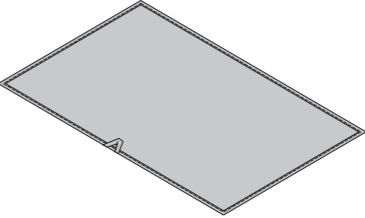
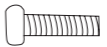
Item no. Nr. N° d'article Articolo No. Artículo No.	Reference Image Referenzbild Image de référence Immagine di riferimento Imagen de referencia	Qty. Menge Qté. Qtà Cant.
A		X1
B		X1

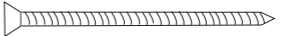
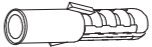
Item no. Nr. N° d'article Articolo No. Artículo No.	Reference Image Referenzbild Image de référence Immagine di riferimento Imagen de referencia	Qty. Menge Qté. Qtà Cant.
C		X1
D		X1
E		X2
F		X8

Item no. Nr. N° d'article Articolo No. Artículo No.	Reference Image Referenzbild Image de référence Immagine di riferimento Imagen de referencia	Qty. Menge Qté. Qtà Cant.
G		X8
H	 M6X25mm	X6
I	 M6X10mm	X6
J	 M5X60mm	X2
K		X2
L		X4
M		X1

1

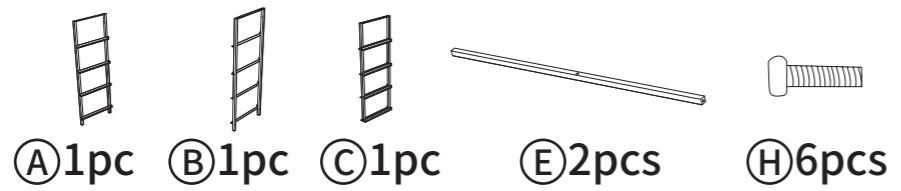

Please make sure that the iron frames are placed in the correct position and facing the correct direction.

Bitte vergewissern Sie sich, dass die Eisenrahmen gut aufgestellt sind und in die richtige Richtung zeigen.

Veillez vous assurer que les cadres en fer sont placés dans la bonne position et dans la bonne direction.

Assicurarsi che i telai di ferro siano posizionati nella posizione corretta e rivolti nella direzione corretta.

Asegúrese de que los marcos de hierro están en la posición correcta y en la dirección correcta.

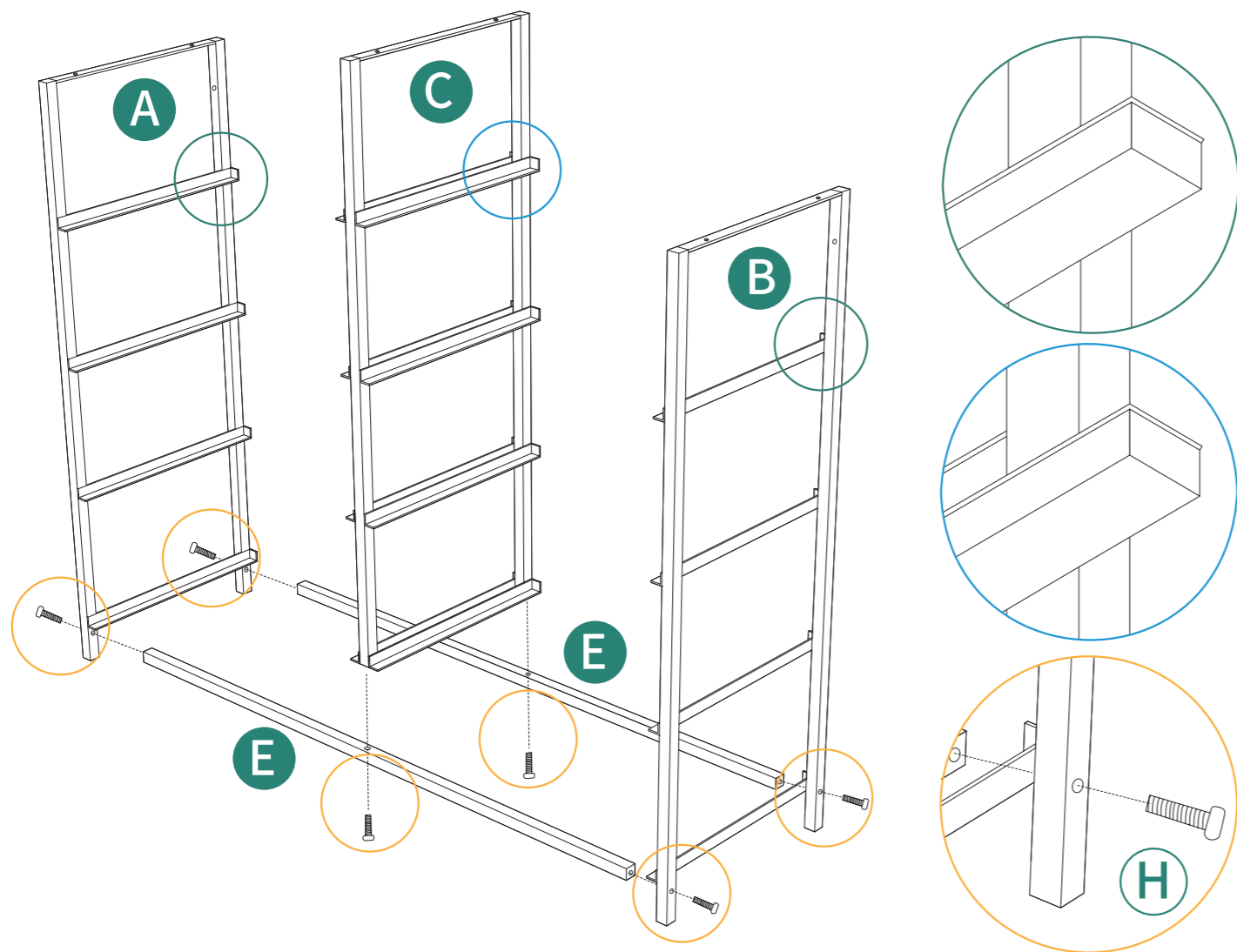

5

2

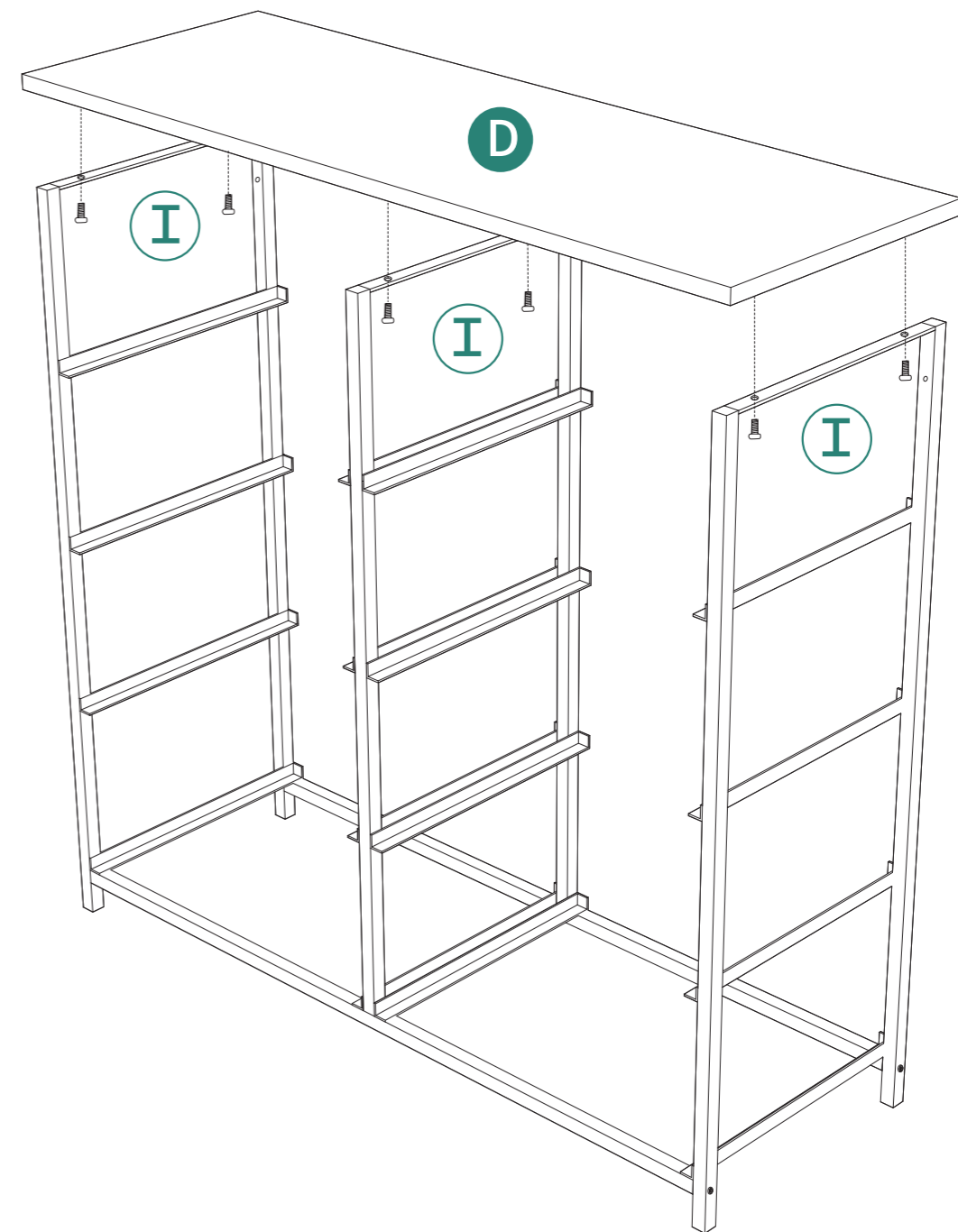
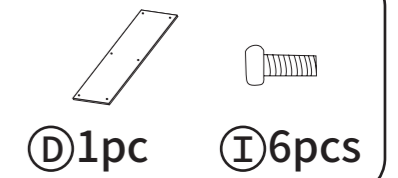

6

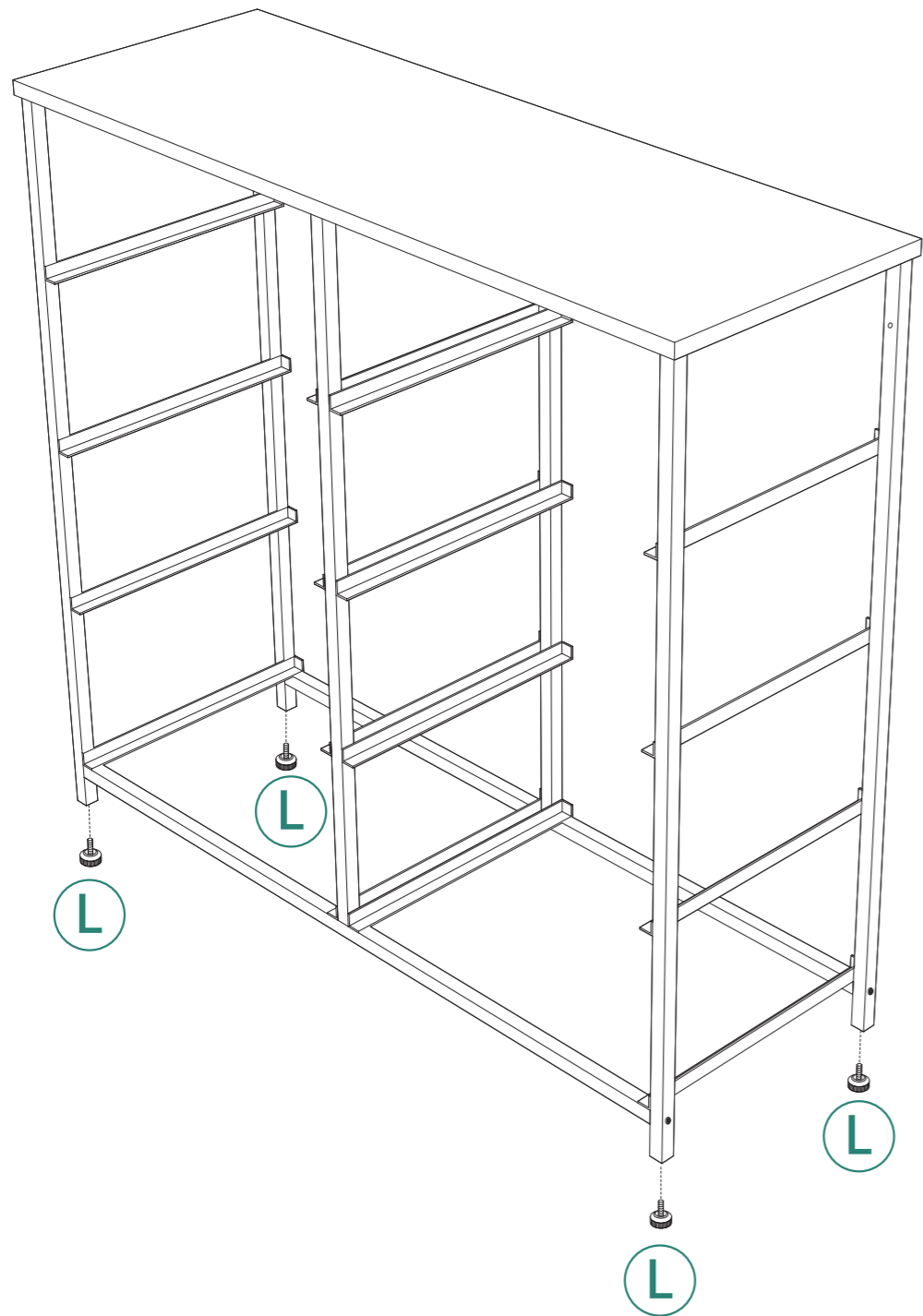
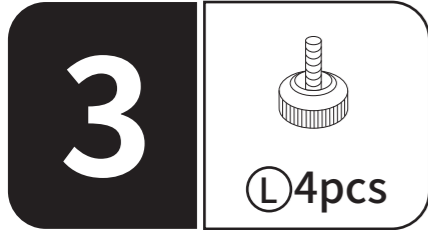

7

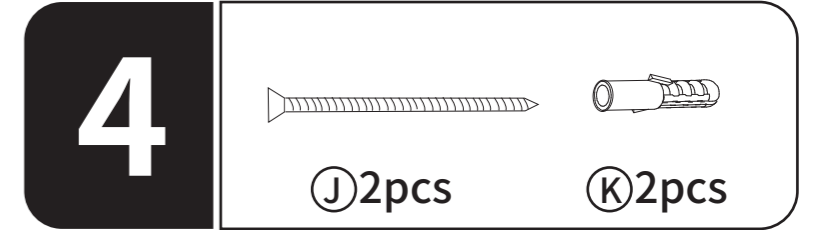

Fixing the fabric dresser to the wall is recommended. Please follow the instructions.
 Es wird empfohlen, die Stoffkommode an der Wand zu befestigen.
 Bitte befolgen Sie die Anweisungen.

Il est recommandé de fixer la commode en tissu au mur.
 Veuillez suivre les instructions.

Si consiglia di fissare il comò in tessuto alla parete.
 Seguire le istruzioni.

Se recomienda fijar la cómoda de tela a la pared.
 Por favor, siga las instrucciones.

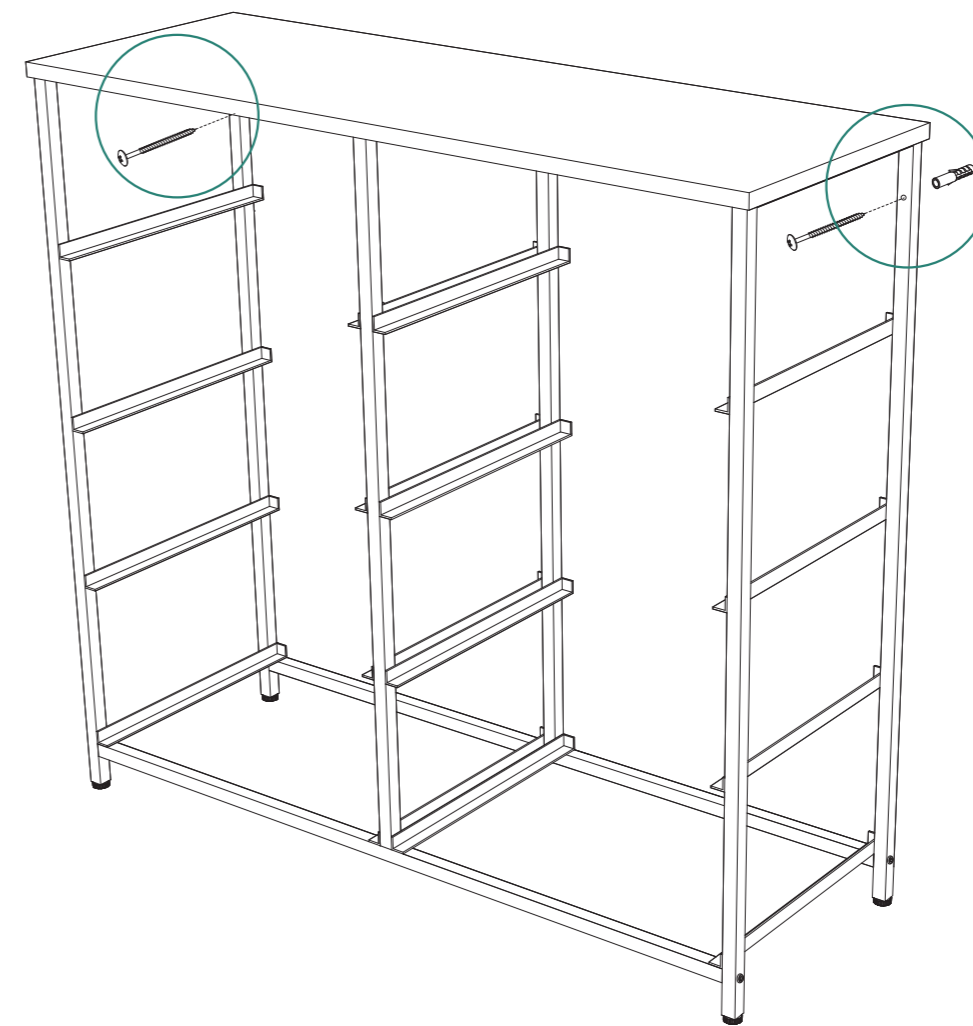

8

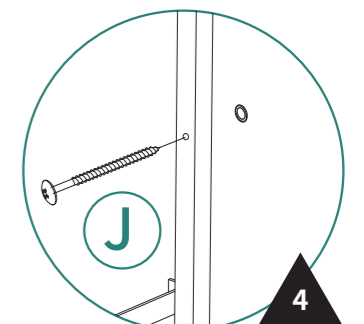
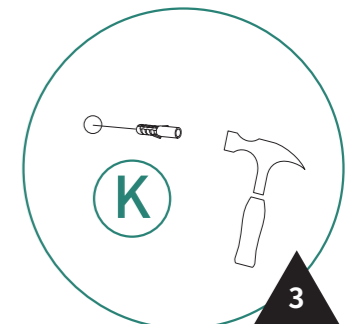
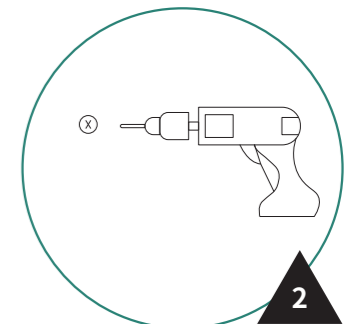
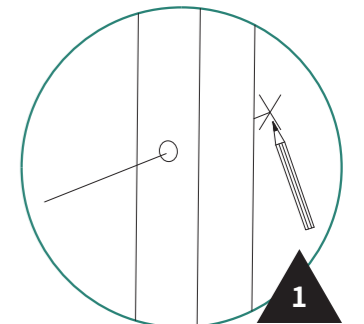

5
X8

ⓕ 8pcs ⓐ 8pcs

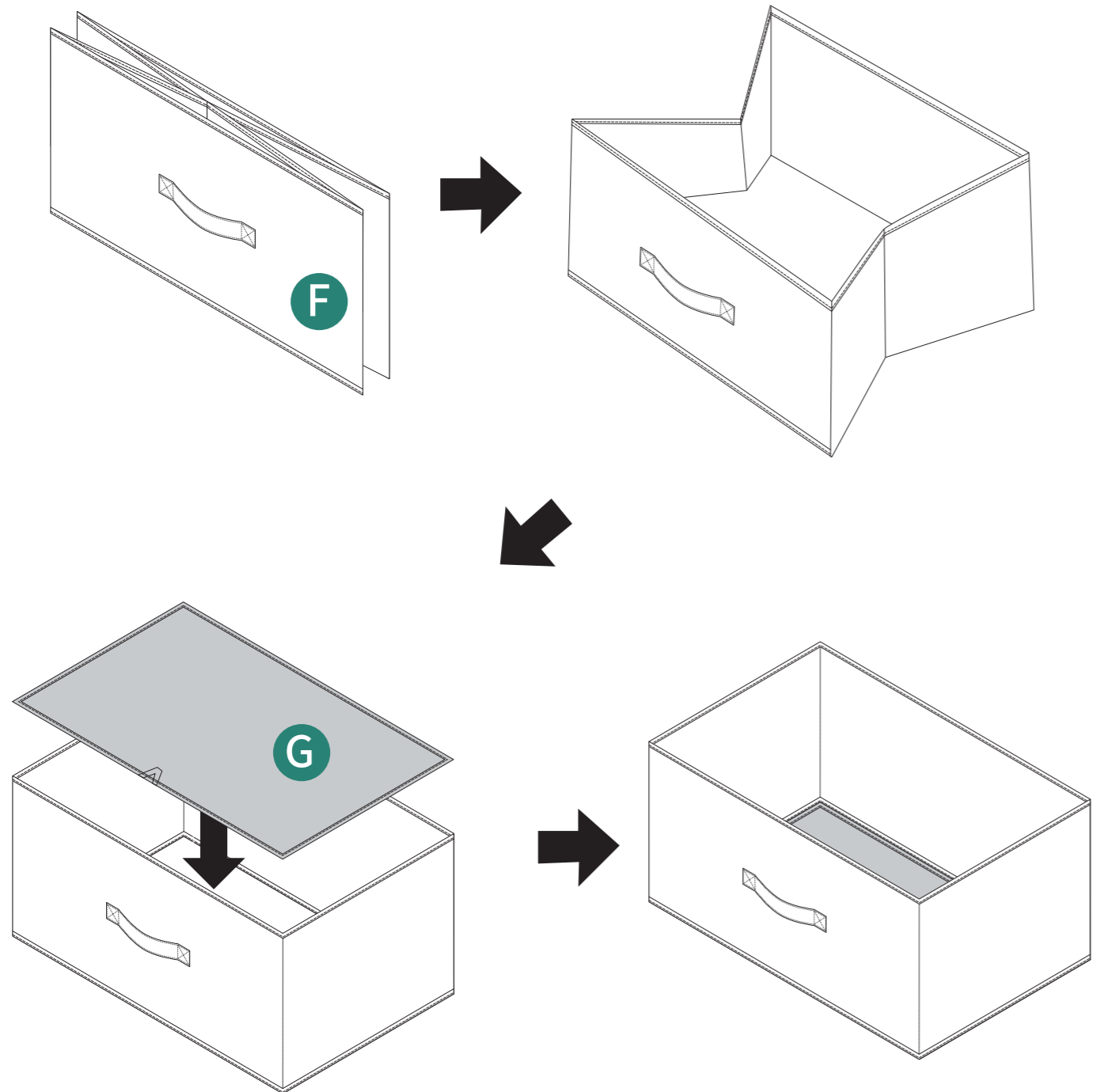

6



- Installation Completed
- Installation abgeschlossen
- Installation complétée
- Installazione completata
- Instalación completada