

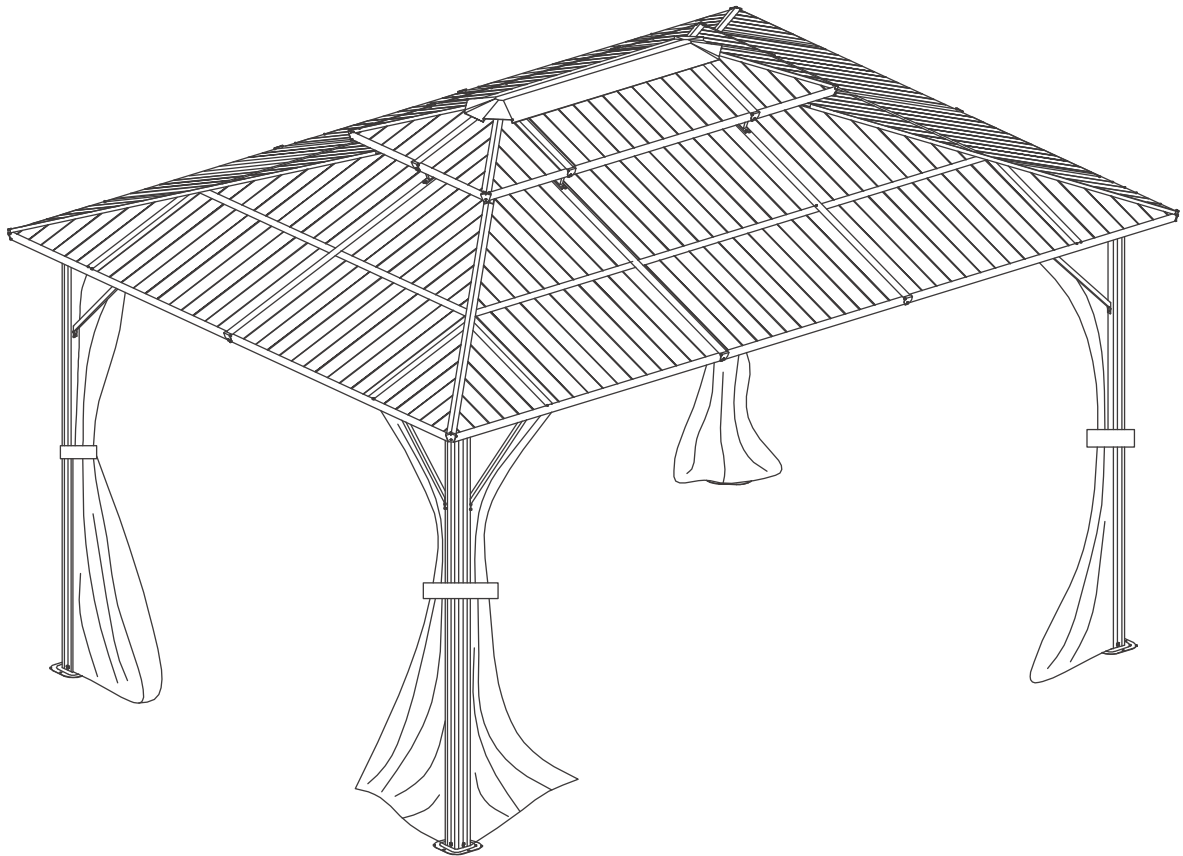

VEIKOUS



www.veikous.com



customerservice@veikous.com

STOP

**MISSING A PART?
CALL US BEFORE GOING
BACK TO THE STORE**

The store where you made your purchase
Does not stock parts for this item.
If you have assembly questions or you are missing or
have damaged parts, please call

1-858-324-1911

(Mon - Fri, 10:00 am to 7:00 pm EST)

you can also e-mail customerservice@veikous.com

or visit www.veikous.com

Please prefer email contact. Due to busy lines,
there may be a wait for calls to be answered.

Please have the following information ready when you make your call:

- Model Number of the product located on the front of the assembly manual
 - Description of the part from the parts list
-
- Read entire assembly manual, paying special attention to the important tips and safety information .
 - Ensure there are no missing pieces by first separating and identifying all parts.
 - Make sure to check packing material for small parts that may have fallen out during shipment.
 - Structures are not intended for public use. The Company does not warranty any of its residential structures subjected to commercial use such as: Daycare, Preschool, Nursery School, Recreational Park, or any similar Commercial Application.
 - This manual contains helpful information concerning assembly preparation, installation procedure and required maintenance.
 - Always keep safety in mind as your structure is being built.
 - Keep these instructions for future reference.

TOOLS REQUIRED



Electric Screwdriver



Manual Screwdriver



Ladder



Gloves



Spanner

ATTENTION :

1. Please read this instruction carefully before installation and follow it strictly during installation.
2. Ensure that there are no problems later due to installation errors.
3. We have prepared extra screws for you to use in case of loss or damage.

Installation Notes

Please check the quantity of all parts before installation (Please refer to the Parts Lists) and the appearance of the products. Please make sure the product is correct before installation. If there is any problem, please contact us directly.

Make sure the colored panels are facing outwards and all the holes match. The panels are textured, please install the panels in the order specified in the instructions. All lines and holes must be accurately matched to make the storage shed more stable. Please ensure that all screws are tightened to prevent the product from falling apart.

There is a protective film on the surface to protect the product, please tear it off after installation to get the final presentation. If you do not damage the film during installation, it can also remain on the product to protect the product.

Please place the product on a flat ground to prevent leaning and collapse. If the ground is uneven, the door may can't be closed.



Safety Precautions

We recommend two adults to complete the installation. Two adults installed together will make the installation process easier and safer.

The gloves must be carried to prevent hand cuts during installation.

Take care when using power tools near water the use of a residual current device (RCD) is advised. Please use the electric driver carefully during screwing to prevent the screw from slipping and hurting your hand. (We recommend that beginners use a manual screwdriver for installation.) Be careful not to fall when installing the roof. Please steady the ladder and make sure the product placed on a flat ground.

PLEASE KEEP THIS INSTRUCTION FOR FUTURE REFERENCE.

PARTS

A



4PCS

B



2PCS

B1



2PCS

C



2PCS

C1



2PCS

D



4PCS

D1



4PCS

D2



4PCS

D3



4PCS

E



4PCS

E1



2PCS

E2



6PCS

E3



6PCS

F



4PCS

F1













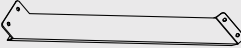
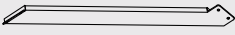

4PCS

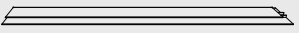
F2

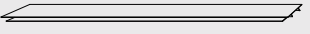

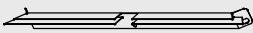
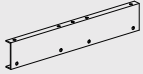



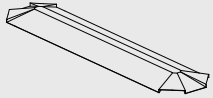



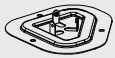

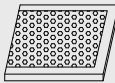
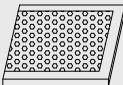
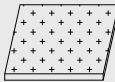

4PCS

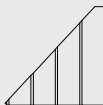

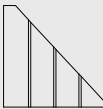
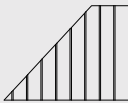

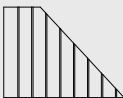

PARTS

G		4PCS
G1		4PCS
H		4PCS
H1		4PCS
I1		4PCS
J2		4PCS
I		4PCS
J		4PCS
J1		2PCS
K		2PCS
K1		2PCS
O		4PCS
P		4PCS
Q		4PCS
Q1		6PCS
R		1PC

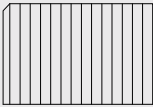
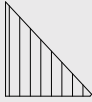
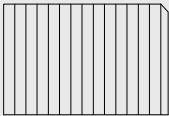
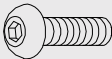
PARTS

S		1PC	T		4PCS
X		12PCS	Y		12PCS
Y1		4PCS	W2		1PC
W		4PCS	W1		4PCS
Z		112PCS+6PCS	L1		4PCS
M4		2PCS	L2		4PCS
M1		4PCS	M3		4PCS
N1		4PCS	M5		4PCS

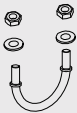
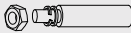
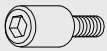
PARTS

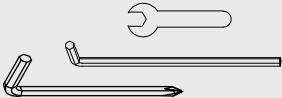
M		4PCS	N5		4PCS
N		4PCS	U	M6x15 	128PCS+4PCS
U1	ST 4.8X12 	48PCS+3PCS	U2	M5x15 	12PCS+2PCS
V1		2PCS	U4	M6x30 	20PCS+2PCS
V3		1PC	V2		12PCS
V		24PCS+2PCS	V4		12PCS
					

PRODUCT ASSEMBLY

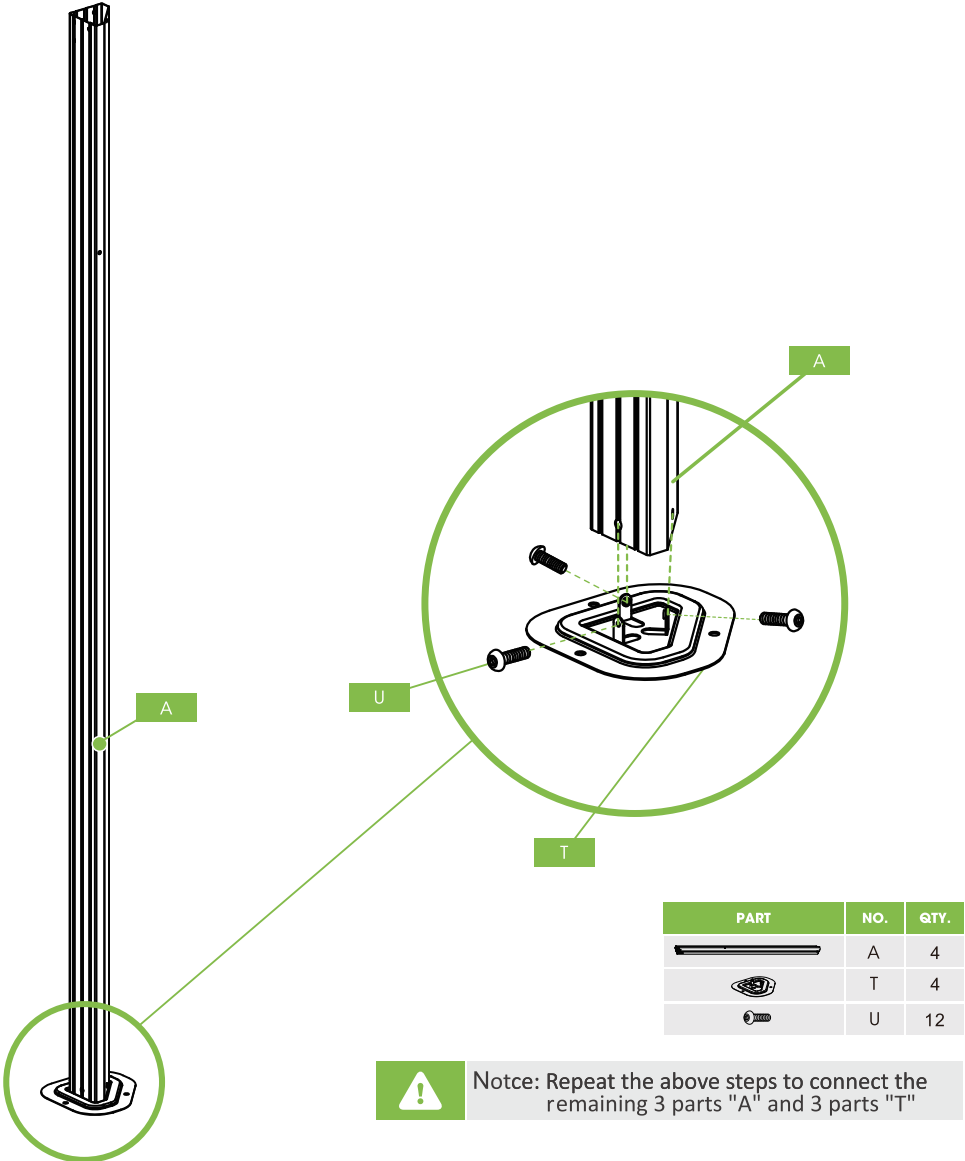

1 Attach the bottom of part "A" to part "T" and tighten with 3 screws "U".

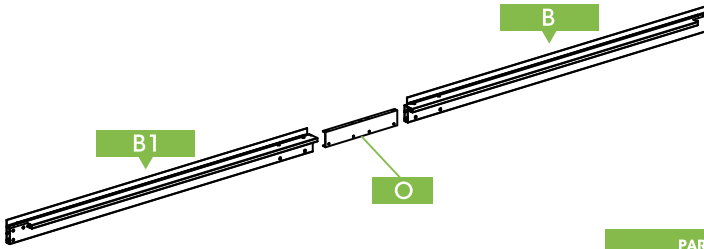

PRODUCT ASSEMBLY

- 2** Place the connecting part "O" in the right frame of part "B1" and in the left frame of part "B".



PART	NO.	QTY.
	B	2
	B1	2
	O	2

- 3** Connecting part "B" and part "B1" with 12 screws "U"

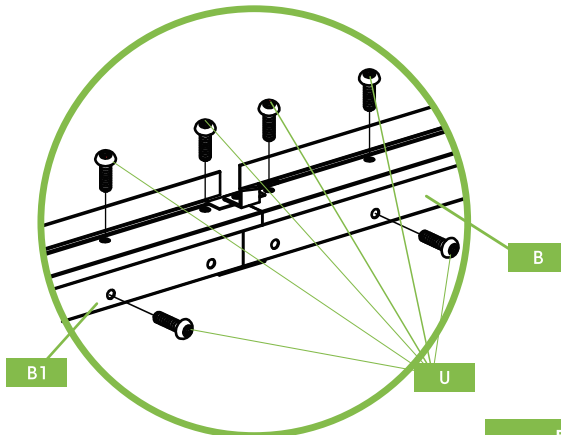

PART	NO.	QTY.
	U	12





Notice: Before fixing, please make sure all the screw holes are aligned

PRODUCT ASSEMBLY

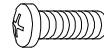
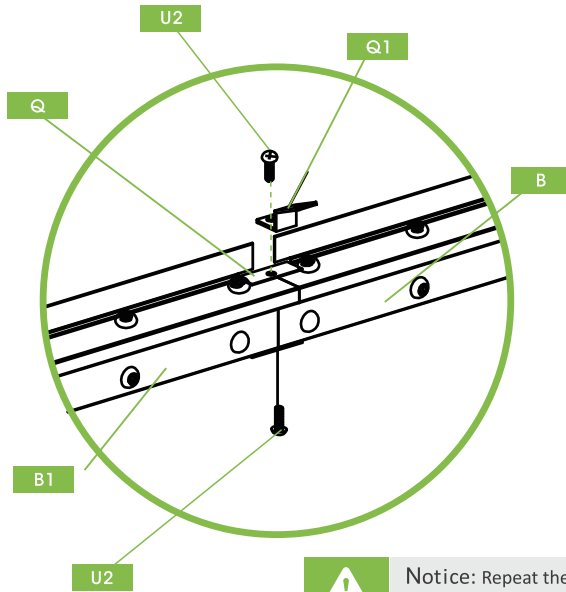
- 4** A part "Q" and a part "Q1" are connected with a screw "U2" on the outside of the connection.







PART	NO.	QTY.
	Q	2
	Q1	2
	U2	4

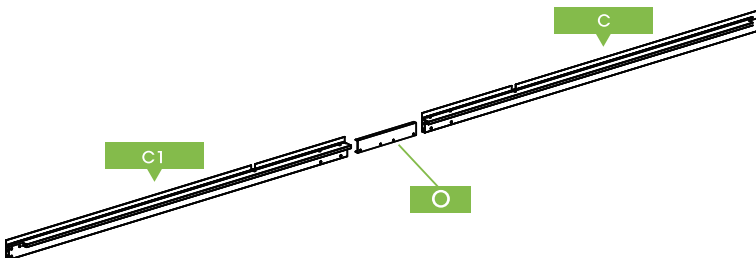

Notice: Repeat the above steps to connect the remaining 1 part "B" and 1 part "B1"

- 5** Place the connecting part "O" in the right frame of part "C1" and in the left frame of part "C".





PART	NO.	QTY.
	C1	2
	C	2
	O	2

PRODUCT ASSEMBLY

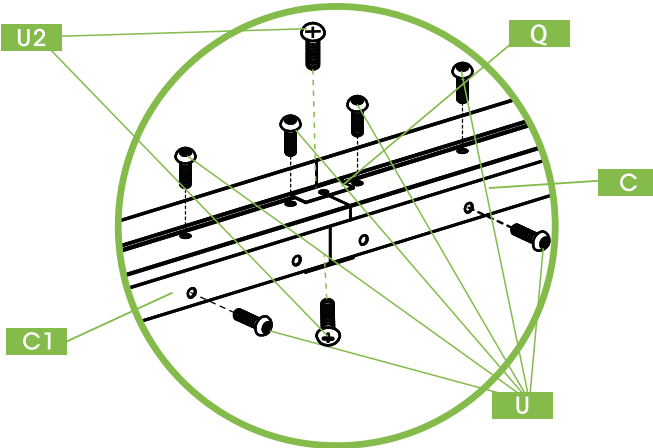
6 Connecting part "C" and part "C1" with 12 screws "U", fixed with 4 screws "U2".





PART	NO.	QTY.
	Q	2
	U	12
	U2	4

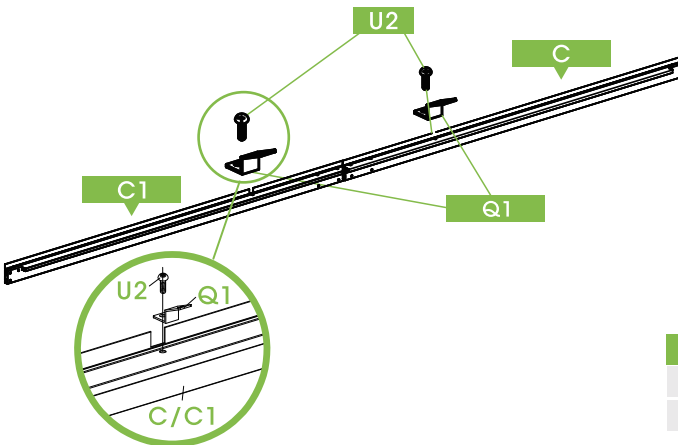

Notice: Before fixing, please make sure all the screw holes are aligned

7 Four part "Q1" is fixed at the top with Four screw "U2".



PART	NO.	QTY.
	Q1	4
	U2	4



Notice: 1. Before fixing, please make sure all the screw holes are aligned
2. Repeat the above steps to finish connecting the other part "C" and part "C1".

PRODUCT ASSEMBLY

- 8** Attach the ends of part "C" and part "C1" to the top of part "A", using six screws "V" to connect the two sides.

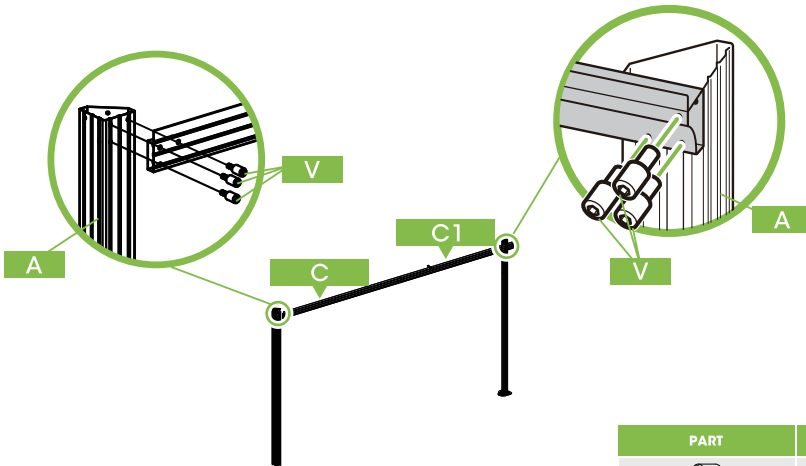

PART	NO.	QTY.
	V	12

- 9** Attach the ends of part "B" and part "B1" to the top of part "A", using six screws "V" to connect the two sides.

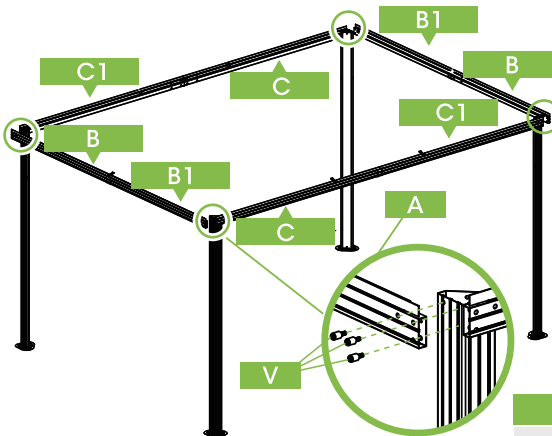

PART	NO.	QTY.
	V	12





Notice: Repeat the above steps to attach the remaining part "B" and part "B1" to the top of part "A".

PRODUCT ASSEMBLY

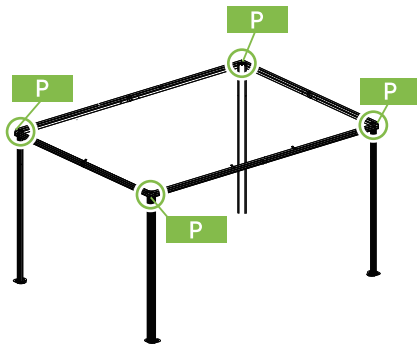
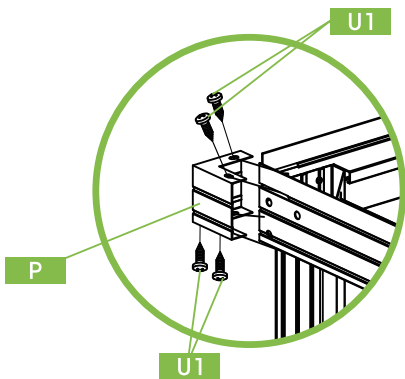

10 Connect the four parts "P" to the four corners and fix them with 16 screws "U1".

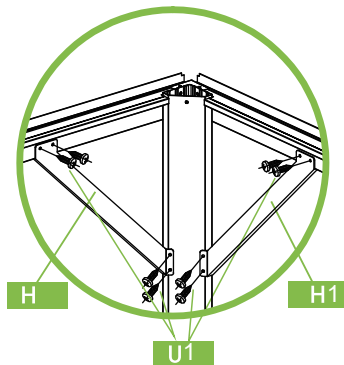
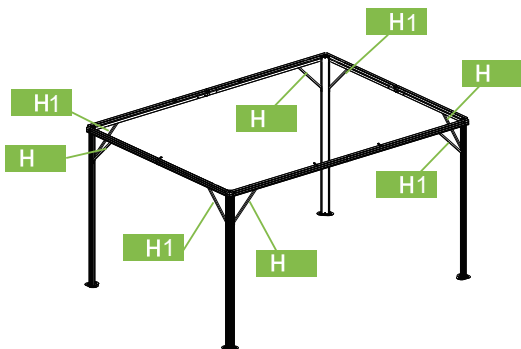

PART	NO.	QTY.
	P	4
	U1	16

11 In the interior view of the gazebo, eight parts "H" and "H1" are attached to the sides of the columns using 16 screws "U1"



PART	NO.	QTY.
	H	4
	H1	4
	U1	32

PRODUCT ASSEMBLY

- 12** 1. Connect the part "D2" and part "D" with 2 screws "U4"
 2. Connect the part "D1" and part "D2" with 2 screws "U"

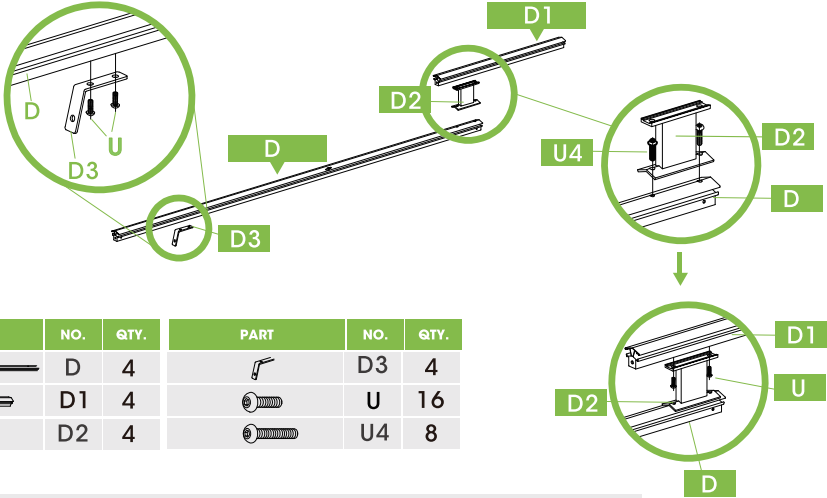

Notice: Repeat the above steps to connect the remaining 3 parts "D1" 3 parts "D2" and 3 parts "D"

- 13** Connect 4 parts "D1" to part "S" and fix them with 8 screws "U".
 Fix part "V3" through part "S".

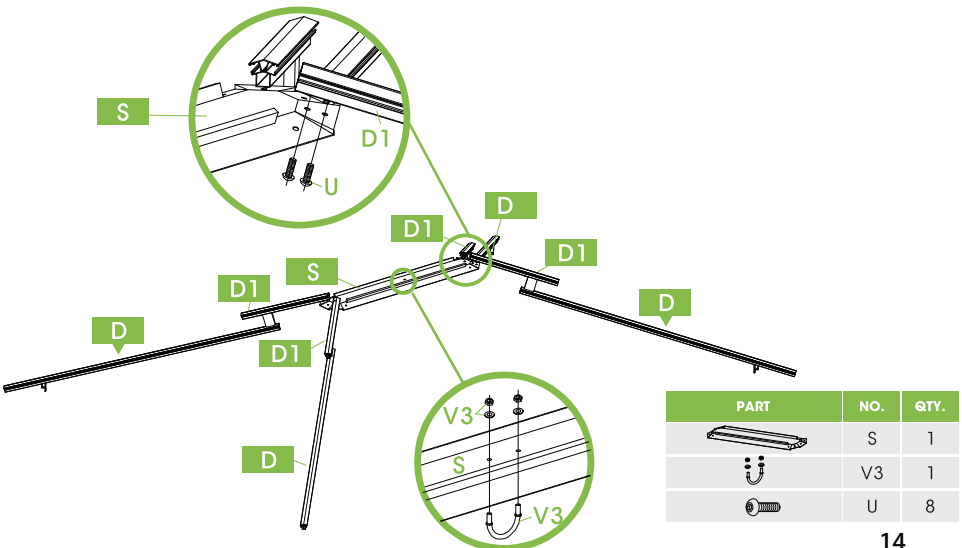

PRODUCT ASSEMBLY

14 Move the whole roof to the shelf and fix the part "D" with four screws "U".

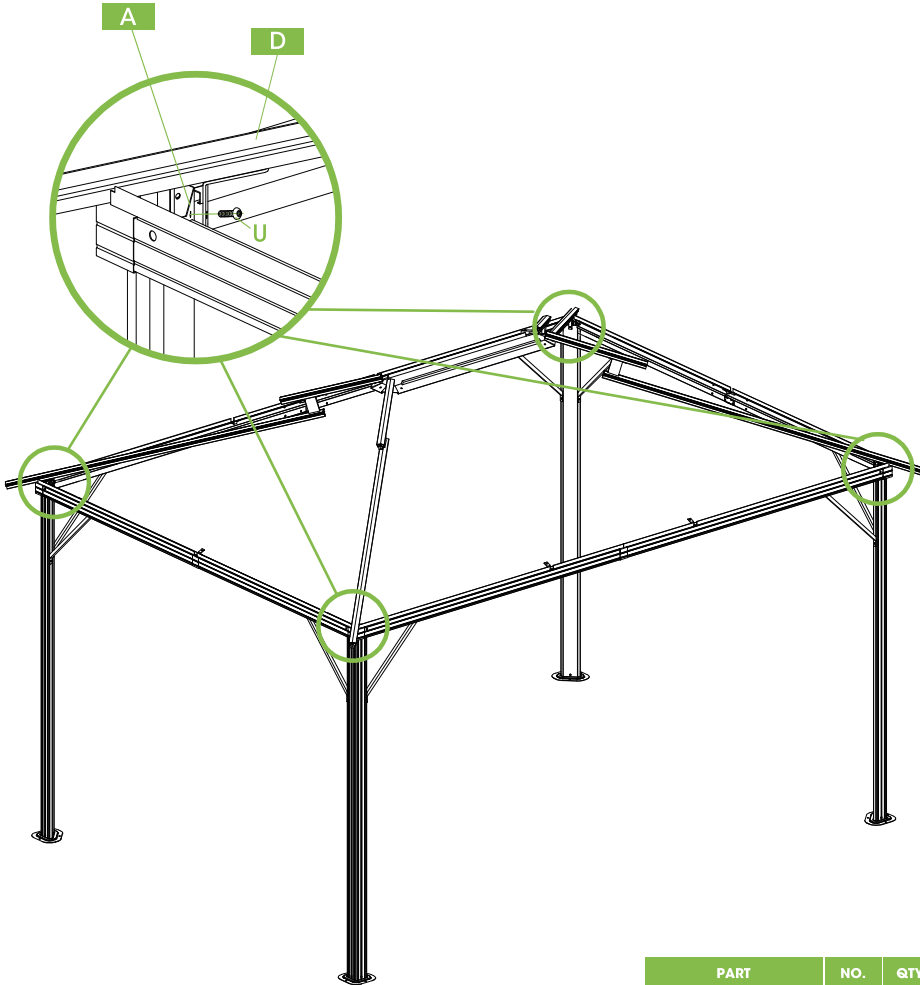

PART	NO.	QTY.
	U	4

PRODUCT ASSEMBLY

- 15** 1. Connect the part "E3" and part "E2" with 2screws "U"
 2. Connect the part "E3" and part "E/E1" with 2screws "U4"

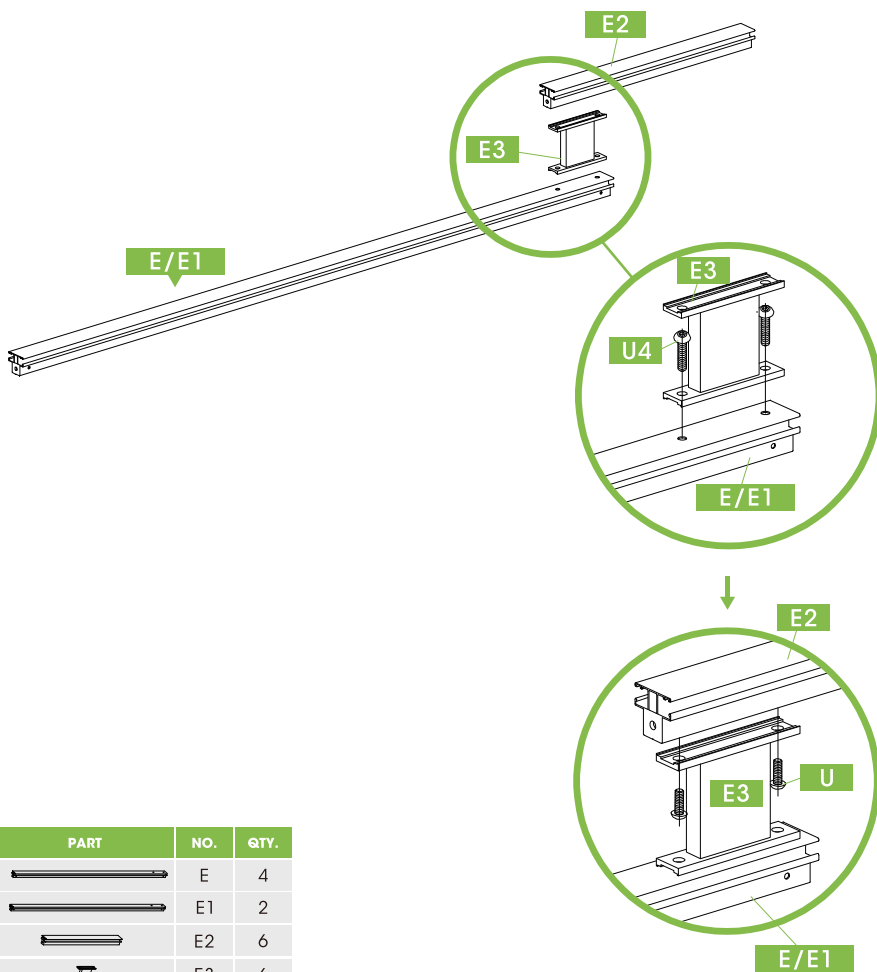

PART	NO.	QTY.
	E	4
	E1	2
	E2	6
	E3	6
	U	12
	U4	12





Notice: Repeat the preceding steps to install the remaining components

I PRODUCT ASSEMBLY

16

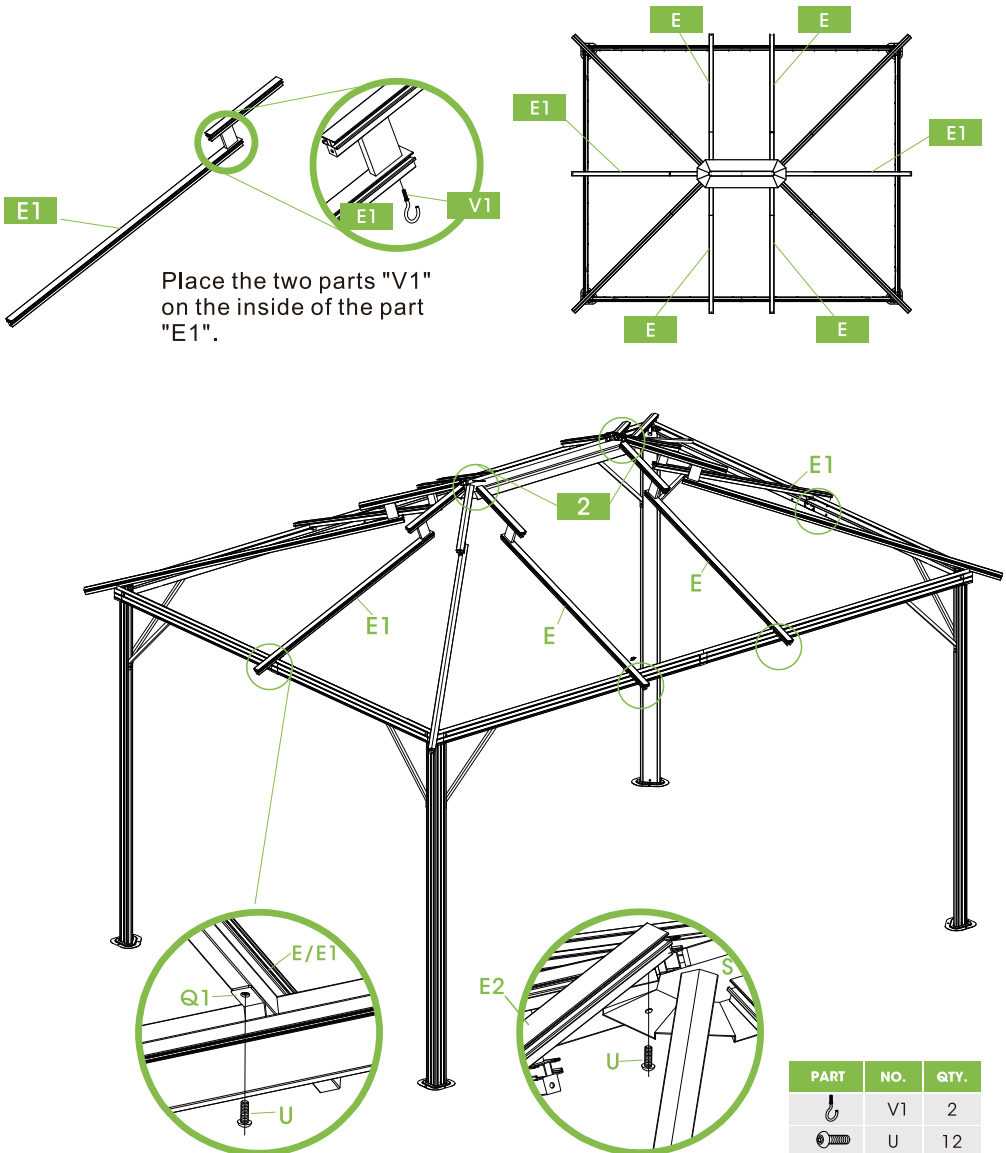
The correct position of part "E1" and part "E" is shown in the figure below. Place part "E1" on both sides and part "E" in the rest of the positions





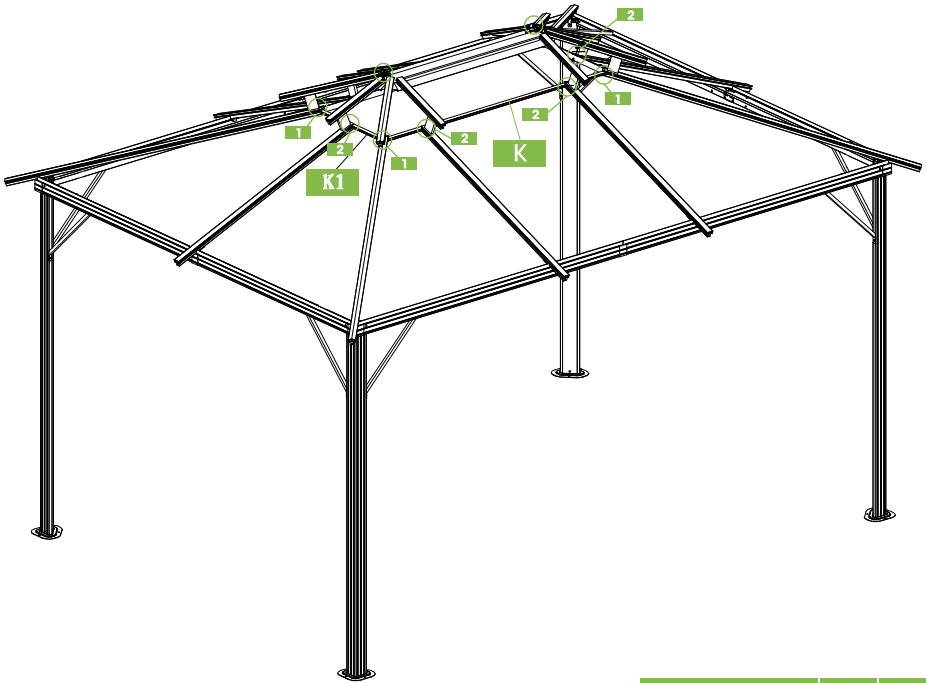
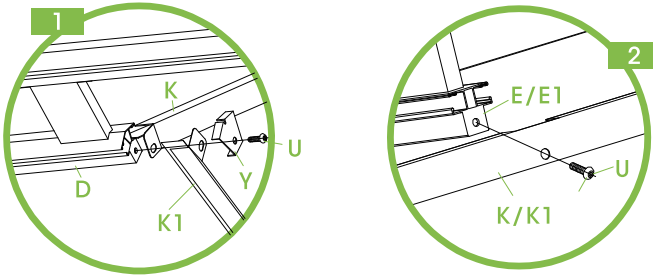

PART	NO.	QTY.
	V1	2
	U	12

PRODUCT ASSEMBLY

17 Use 4 parts "Y" and 10 screws "U" to fix part "K1" and part "K".





PART	NO.	QTY.
	K	2
	K1	2
	Y	4
	U	10

PRODUCT ASSEMBLY

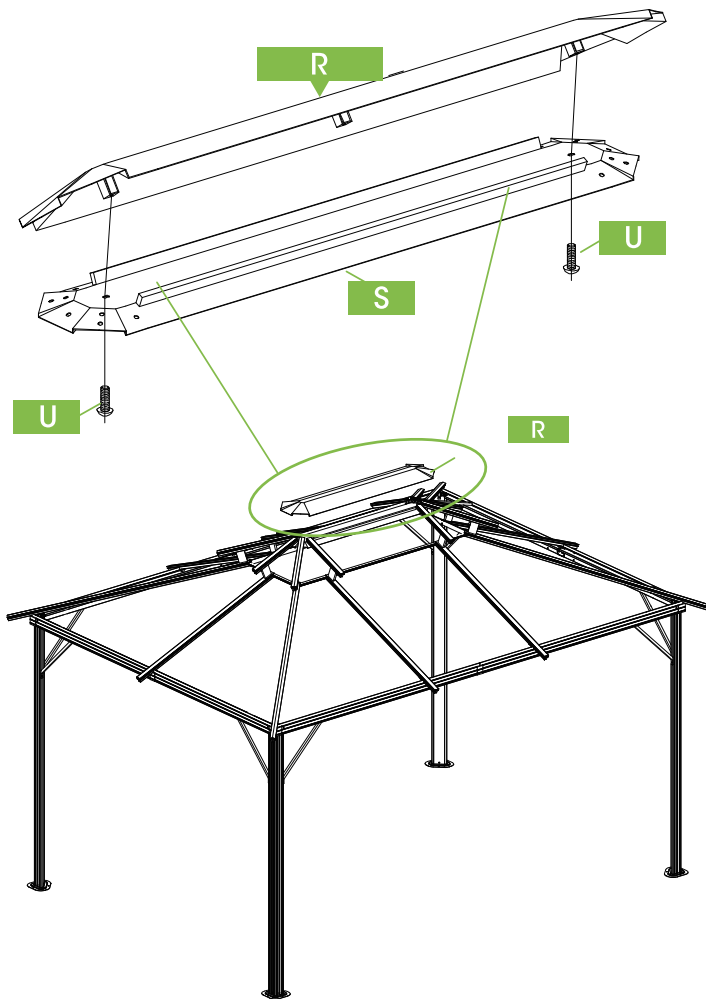
18 Place part "R" on the top of part "S" and secure it with two screws "U".



PART	NO.	QTY.
	R	1
	U	2

PRODUCT ASSEMBLY

- 19** First, place part "L1", part "L2" and part "M4" on the open space in the order of installation, so that they can be installed in order during installation.

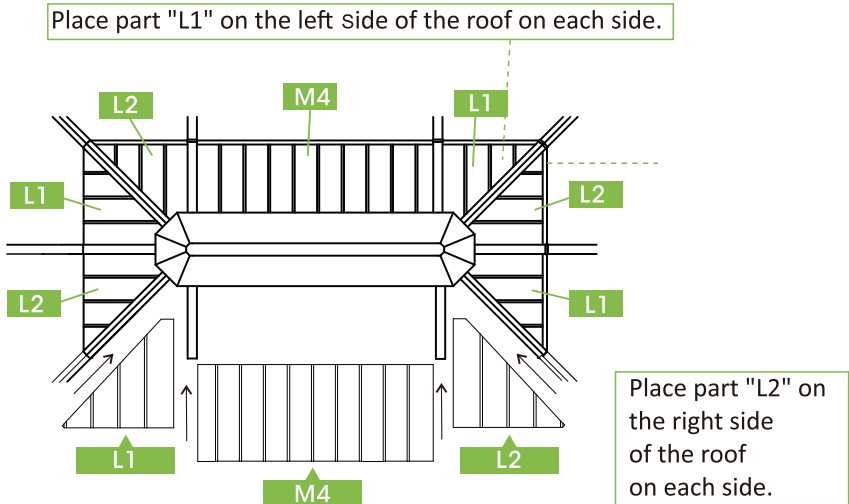

Place two parts "M4" in the middle of part "L1" and part "L2".

PART	NO.	QTY.
	L1	4
	M4	2
	L2	4

PRODUCT ASSEMBLY

20 Use 4 screws "U" to fix the part "Y" in the four corners Fix the part "X" with 6 screws "U".

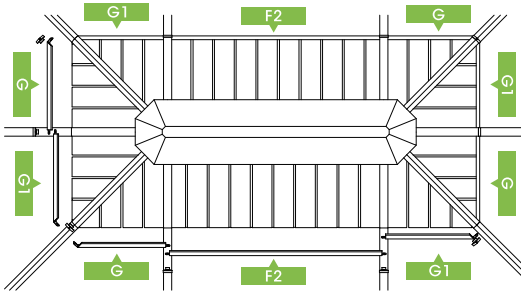

PART	NO.	QTY.
	F2	2
	G	4
	G1	4
	X	6
	Y	4
	U	10

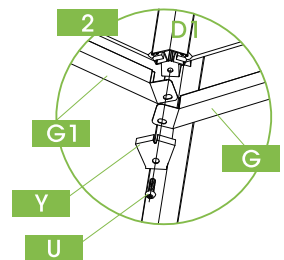
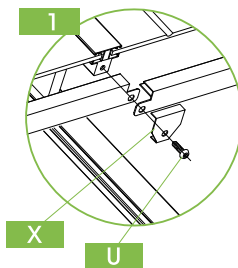
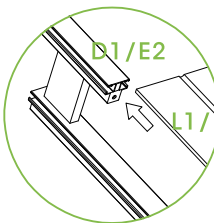
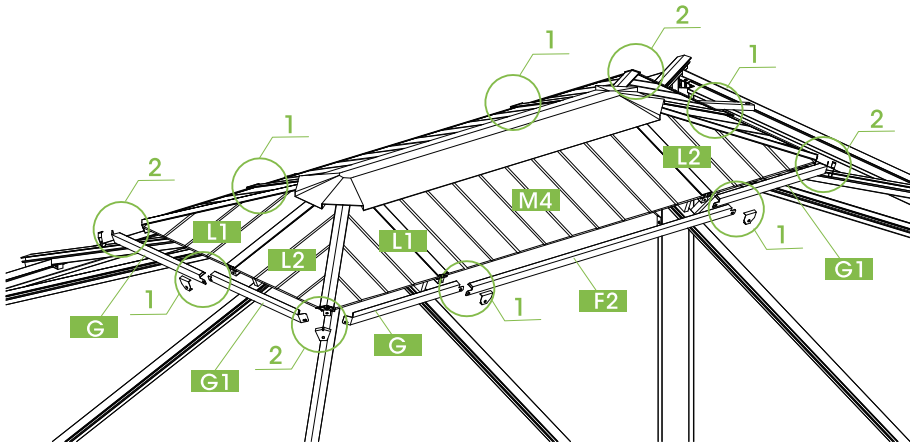

PRODUCT ASSEMBLY

21 The correct part location is shown in the figure below.

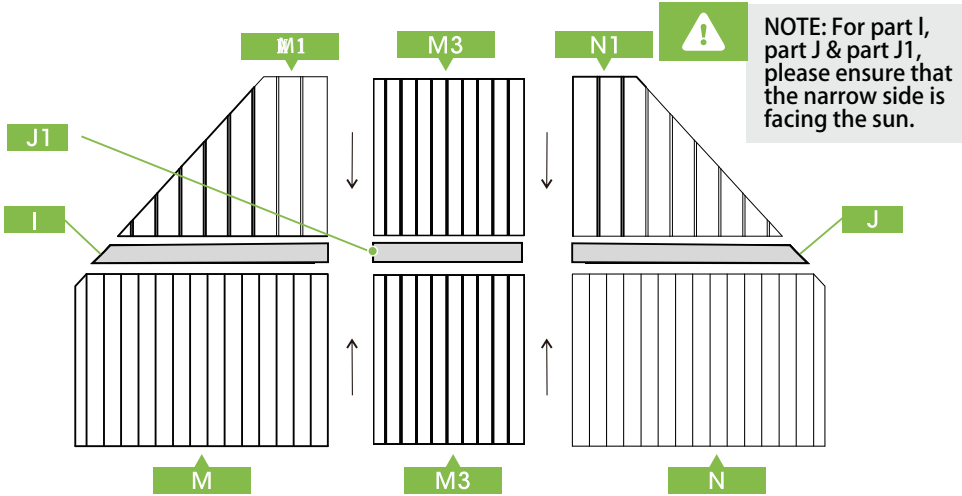

Connecting 4 parts "M" and 4 parts "M1" by

Connecting to parts "M3" with one part "J1"

Connecting 4 parts "N" and 4 parts "N1" by 4 parts "J"

22 The panel mounting method is as follows

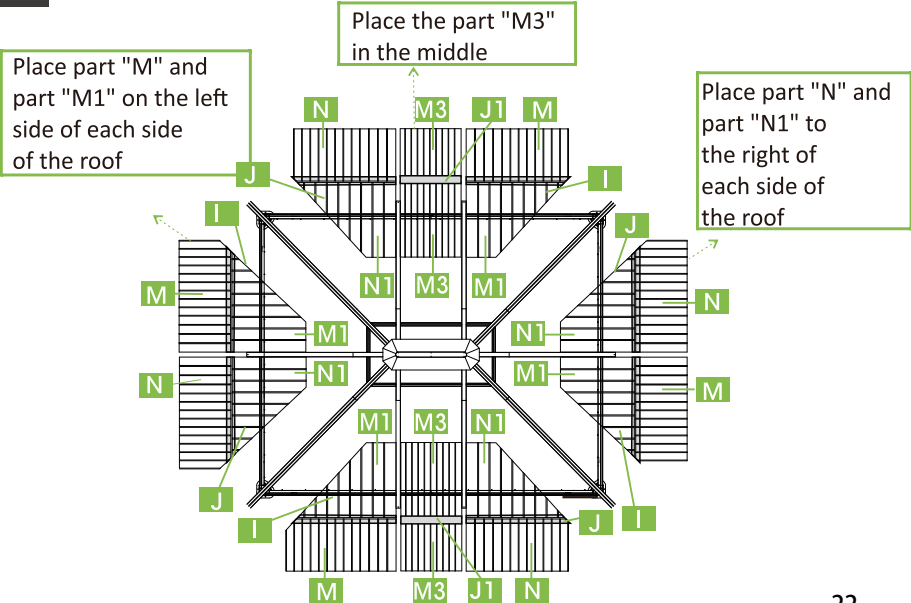



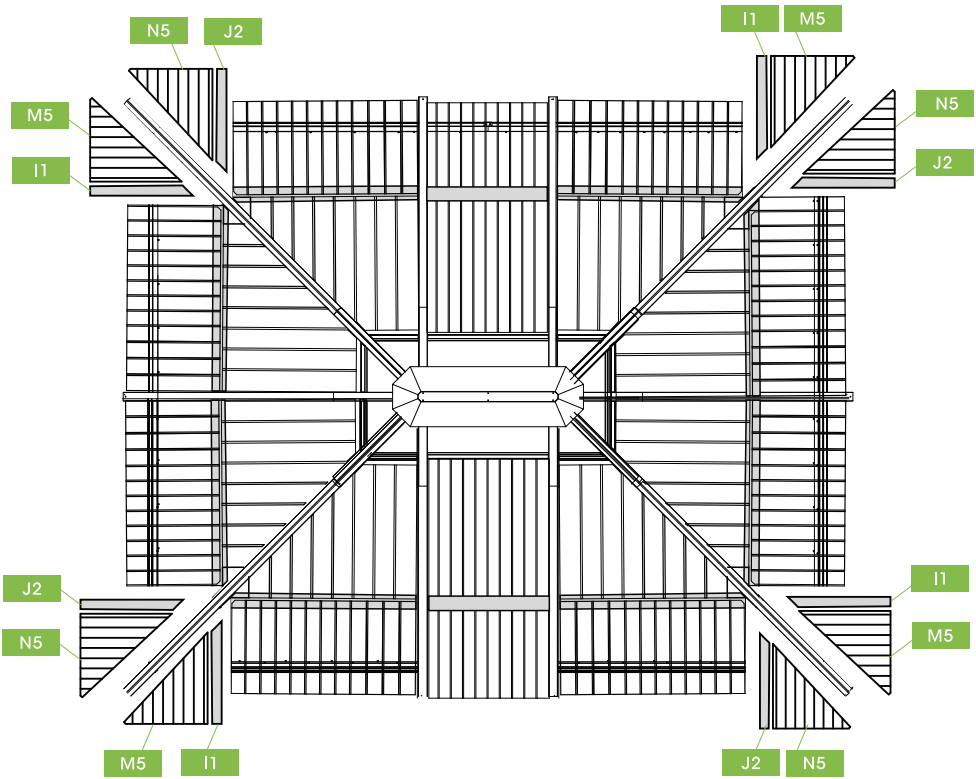

PRODUCT ASSEMBLY

23

The panel mounting method is as follows



PART	NO.	QTY.
	M5	4
	N5	4
	I1	4
	J2	4

PRODUCT ASSEMBLY

24 The positions of parts "F", "F1" and "F2" are as follows.

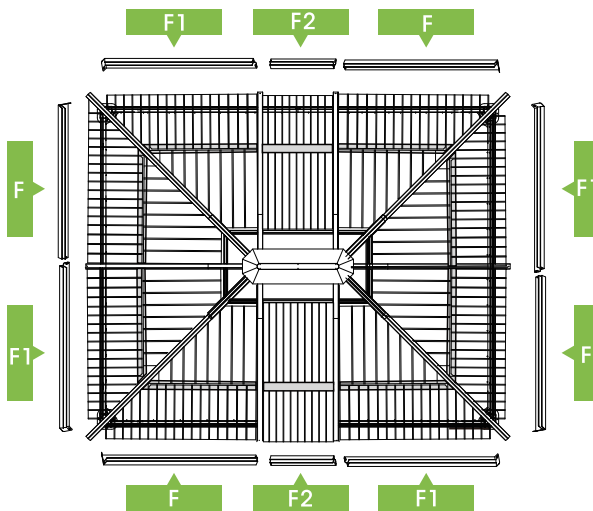

25 Use 6 parts "X" and 6 screws "U" to fix parts "F" and "F2". Use 4 parts "Y" and 4 screws "U" to fix parts "F" and "F1".

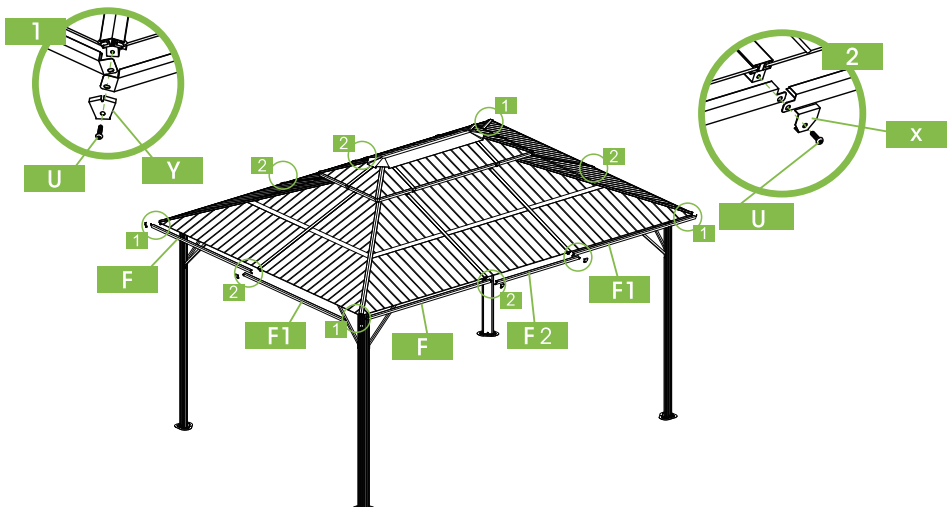

PART	NO.	QTY.	PART	NO.	QTY.
	F	4		Y	4
	F1	4		X	6
	F2	2		U	10

PRODUCT ASSEMBLY

26

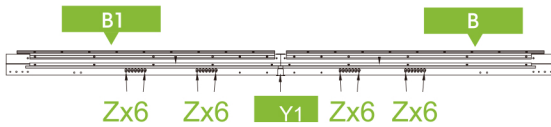
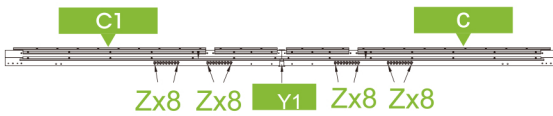
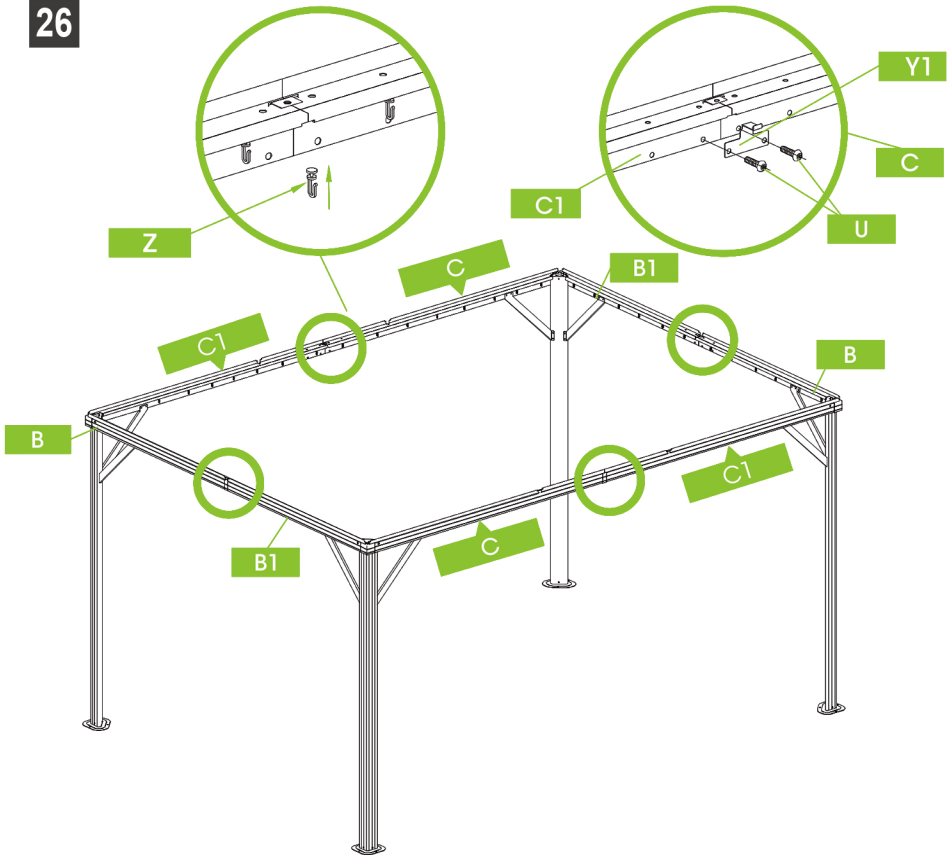

PART	NO.	QTY.
	Y1	4
	U	8
	Z	112

PRODUCT ASSEMBLY

27 Hang part "W" and part "W1" on part "Z", with 8 holes on the long side and 6 holes on the short side.

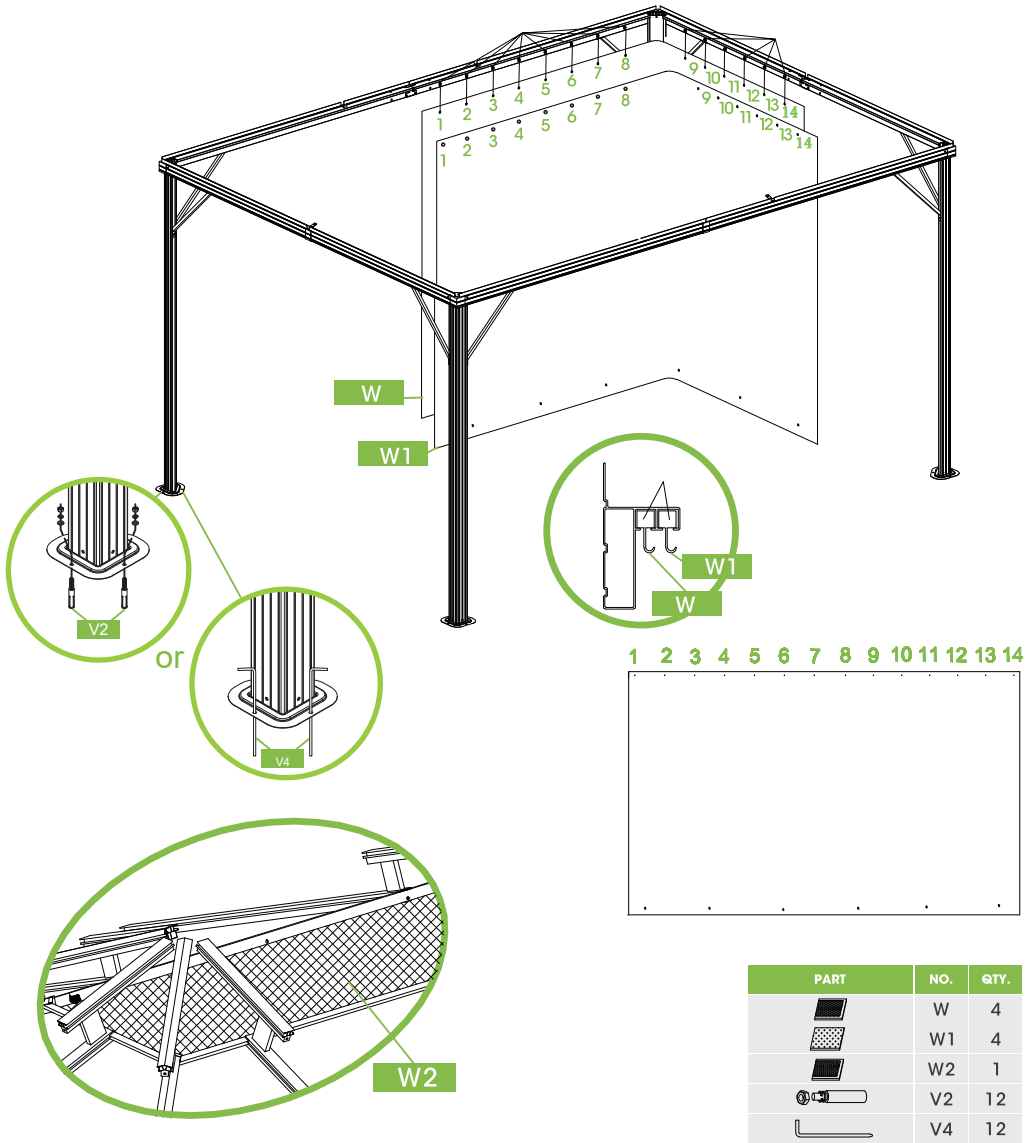

Notice: After installing parts "W" and "W1", fix them to part "A".

ENJOY YOUR PRODUCT!

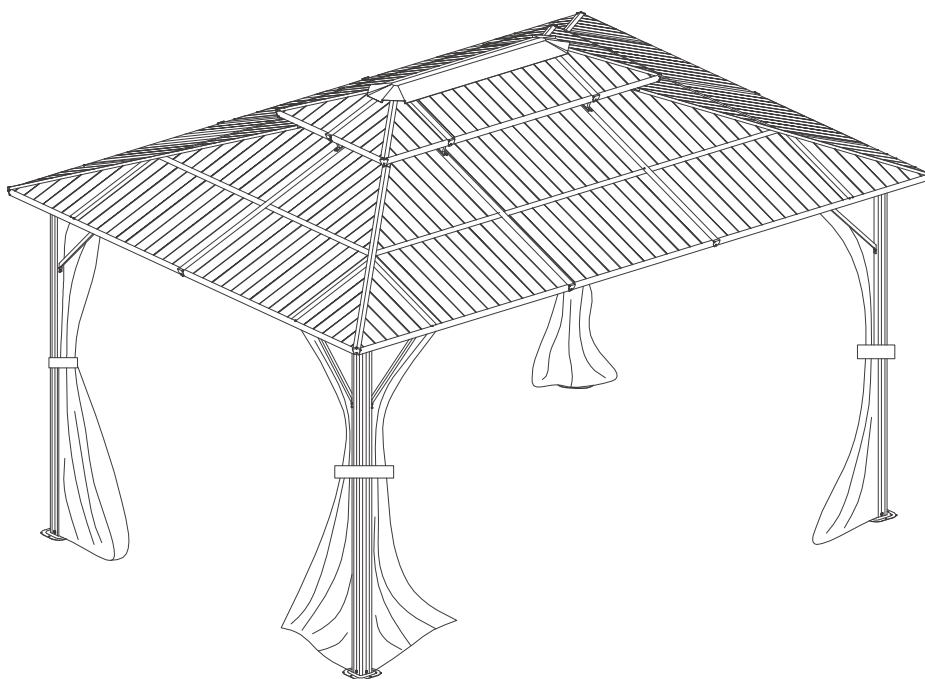

!WARNING

Manufacturer and seller expressly disclaim any and all liability for personal injury, property damage or loss, whether direct, indirect, or incidental, resulting from the incorrect attachment, improper use, inadequate maintenance, or neglect of this product.