

ASSEMBLY INSTRUCTION

DEAR CUSTOMER,

Thank you for purchasing our product. Please read this assembly instruction carefully before assemble and use, and keep it for future reference.

Cautions:

1. Please check whether the outer packaging is intact before opening to avoid damage during transportation.
2. Assemble this product on a flat and clean surface to avoid scratching. It is recommended for one or two people to assemble.
3. After unpacking, please confirm in time all the parts and hardware are included. Please do not discard any packaging, if for any reason you need to return this product, it must be returned in its original packaging.
4. If you have any questions about the products, please send an email to our **AfterSales317@outlook.com** on the website!
5. Please keep small parts out of reach of children or pets to prevent them from swallowing.
6. Please read the installation steps in the Instruction carefully and follow the steps in the Instruction to assemble.

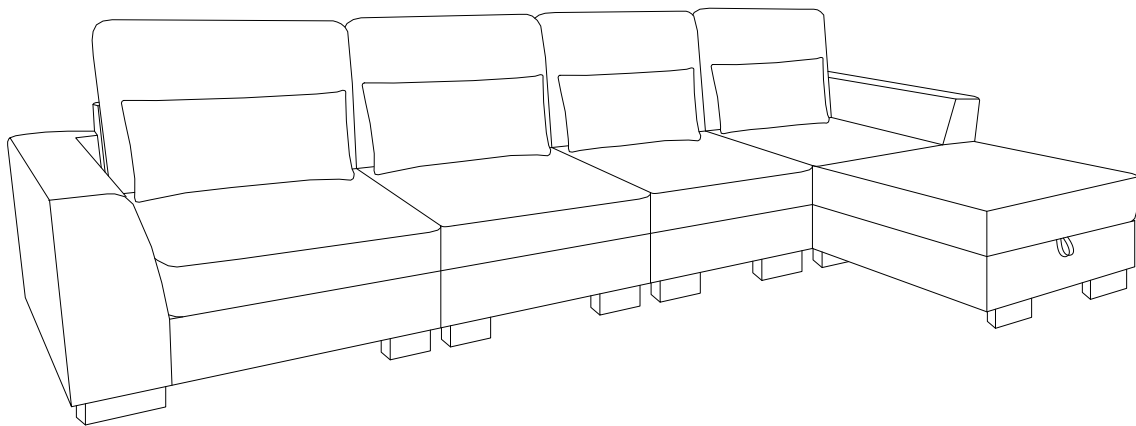

Main support:

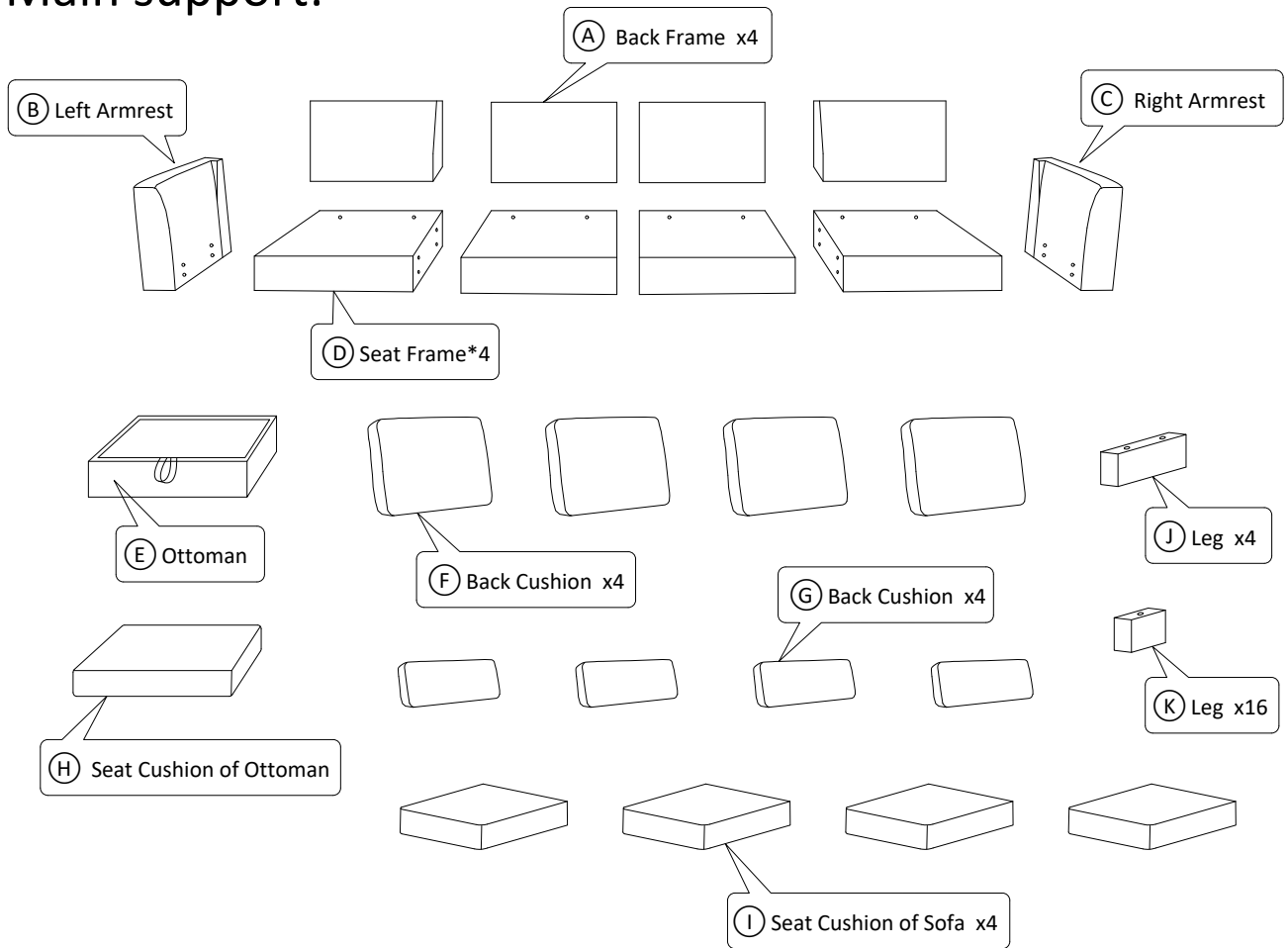

Hardware List :

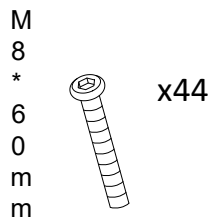

(L) Bolt

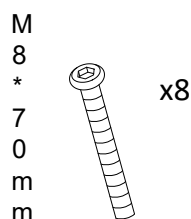

(M) Bolt

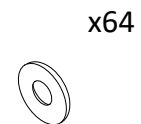

(N) Flat Washer

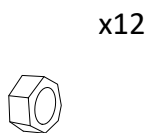

(O) Nut

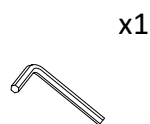

(P) Allen Wrench

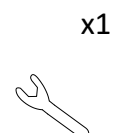

(Q) Open Spanner

Step1 Open the armrests (B) / (C), the seat frames (D) and the ottoman (E), take out the parts which are hidden in them as below shown.

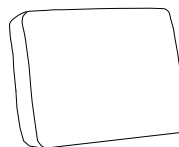
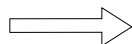
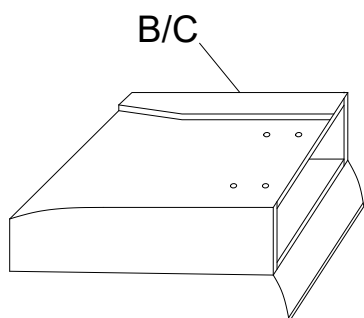

B=F*2

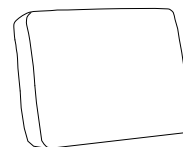

C=F*2

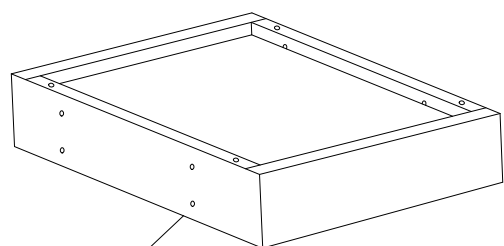

D*4

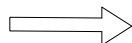

A*4



G*4



I*4

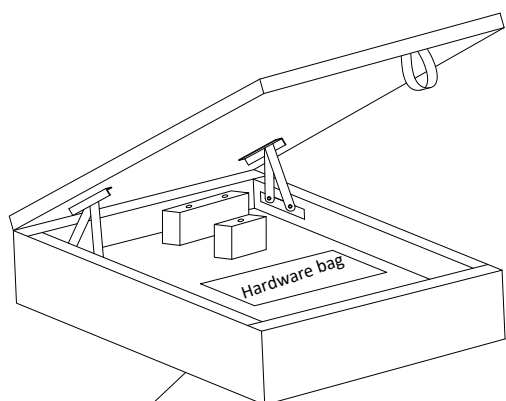

E

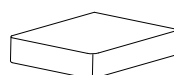
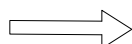

H*1



J*4



K*16

Hardware bag



L*44



M*8



M*64



O*12

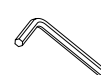



P*1

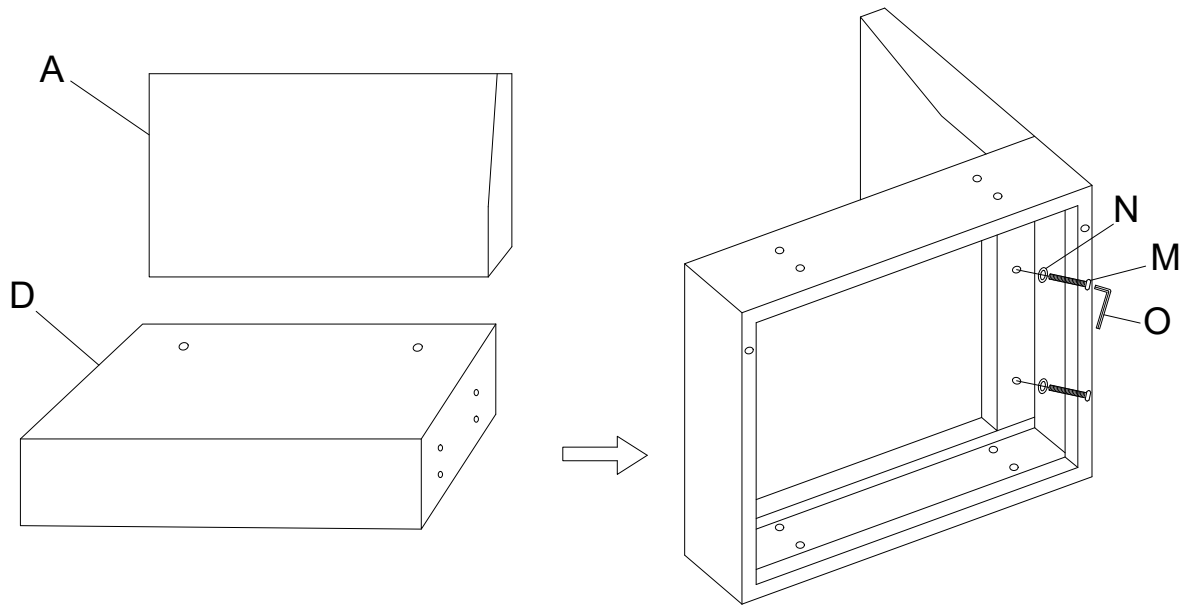

Q*1

Step2 Screw the back frame (A), the seat frame (D) using the flat washer (N), the bolt (M) and the allen wrench (O).



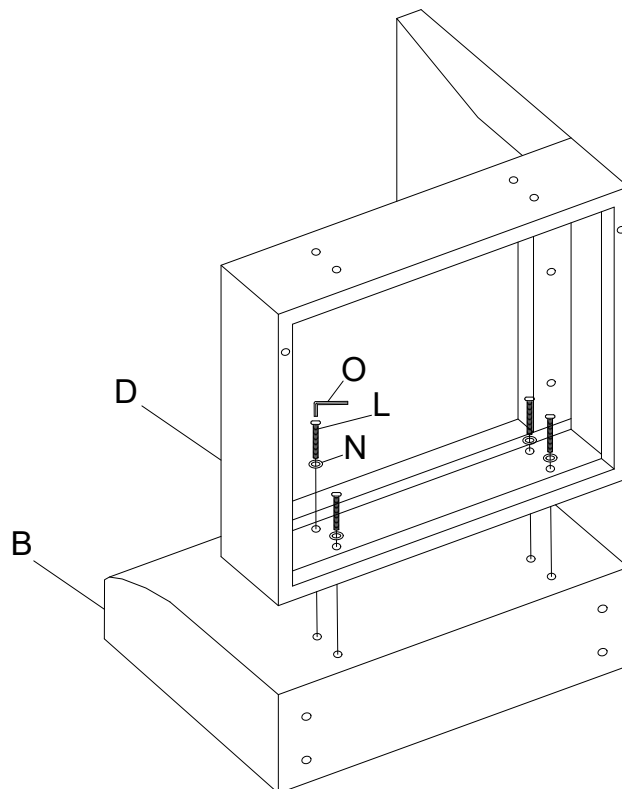

M  x8
N  x8

Step3 Screw the armrests (B)/(C) and the seat frames (D) using the flat washer (N), the bolt (L) and the allen wrench (O).

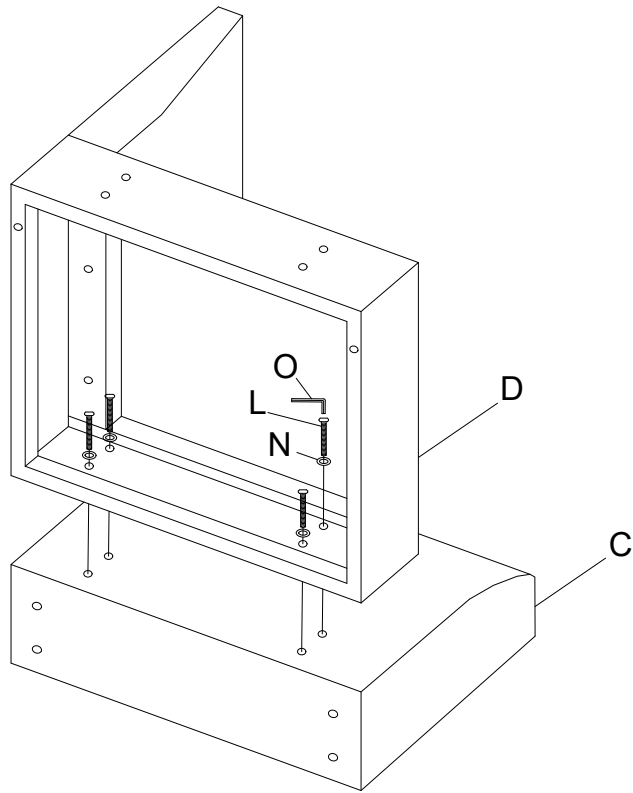





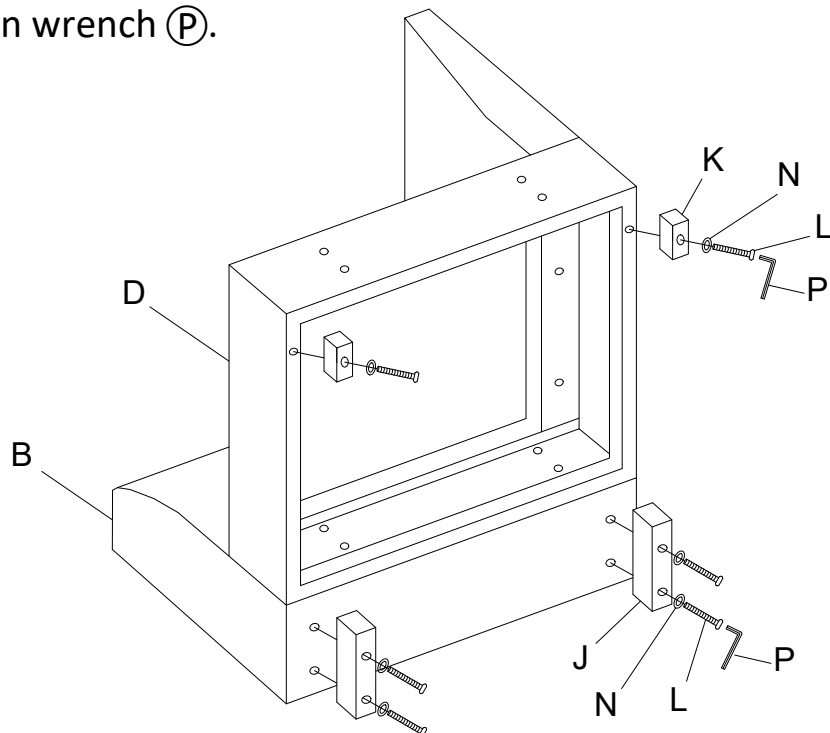

L  x8
 N  x8

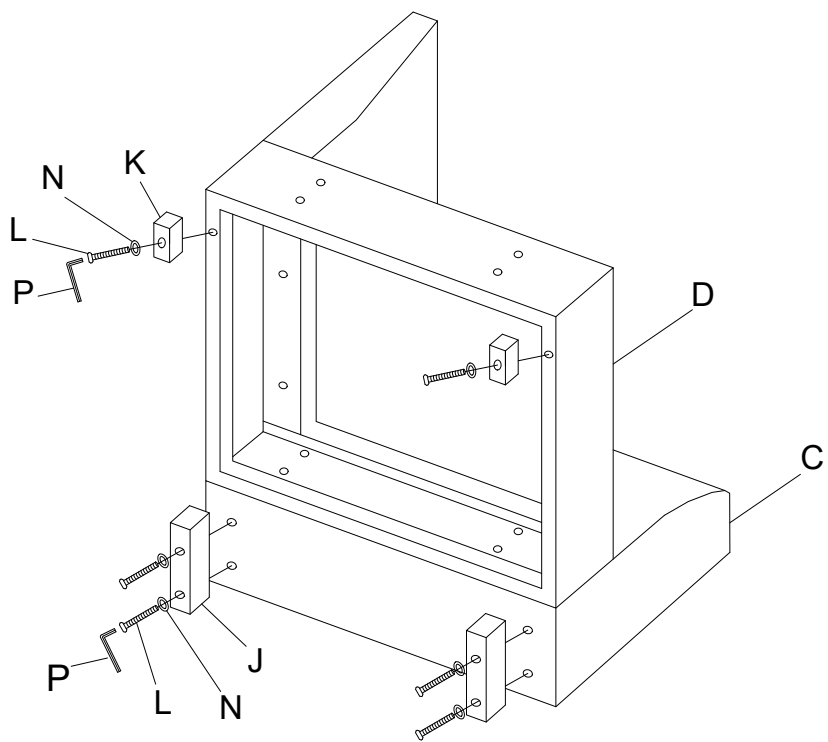
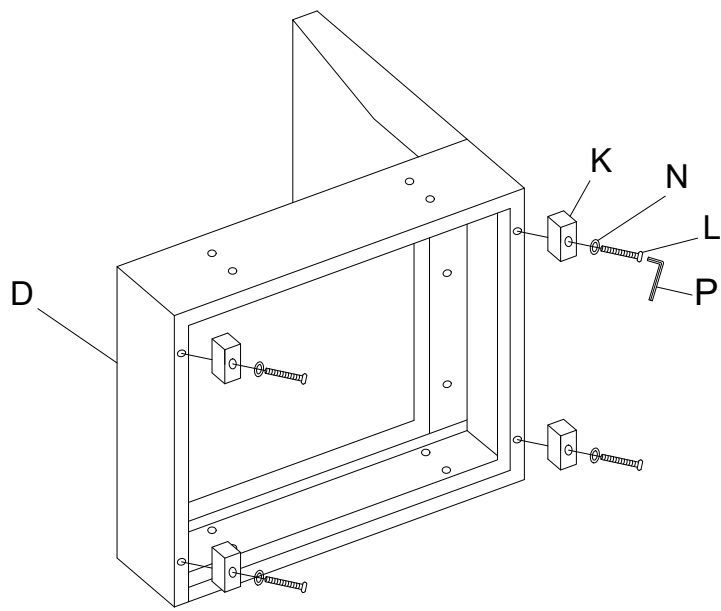

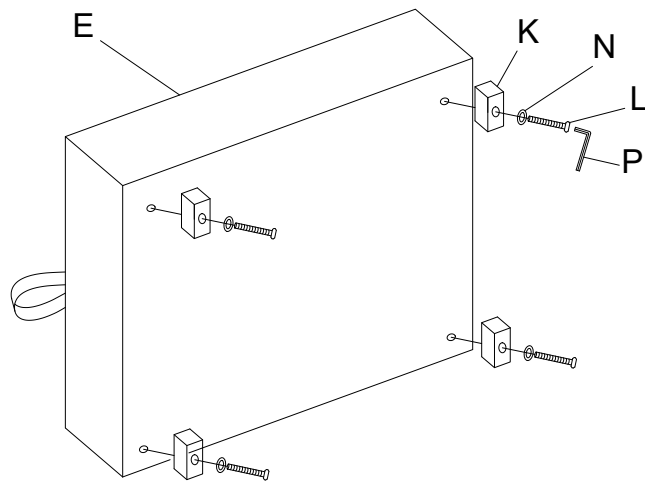



Step4 Screw the armrests (B)/(C),the seat frame (D),the ottoman (E) and the leg (J)/(K)using the flat washer (N),the bolt (L) and the allen wrench (P).









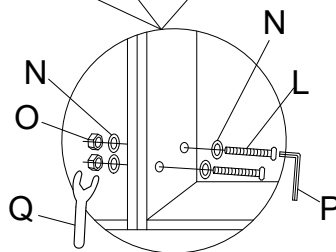
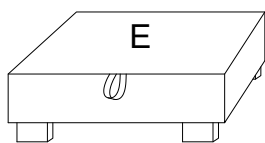
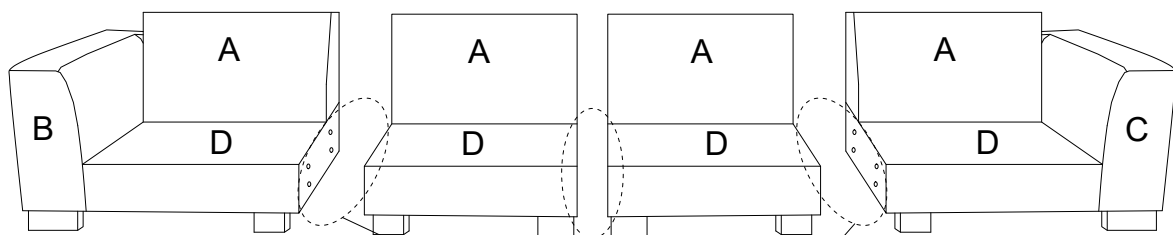

- J  x4
- K  x16
- L  x24
- N  x24

Step5 Screw the four seat frames  using the flat washers , the bolts , the nuts , the allen wrench  and the open spanner .



- L  x12
- N  x24
- O  x12

Step6 Put the seat cushion ①/④ and the back cushion ⑥/⑦ on the sofa.

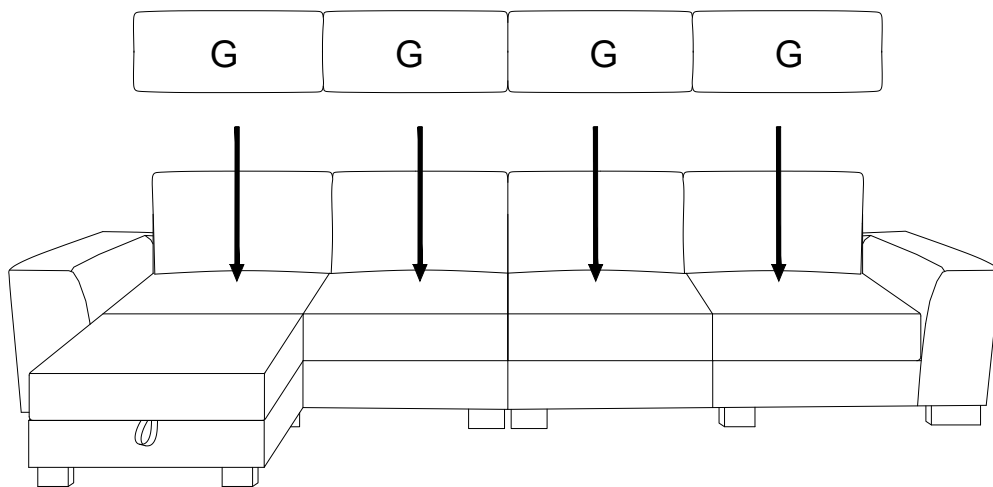
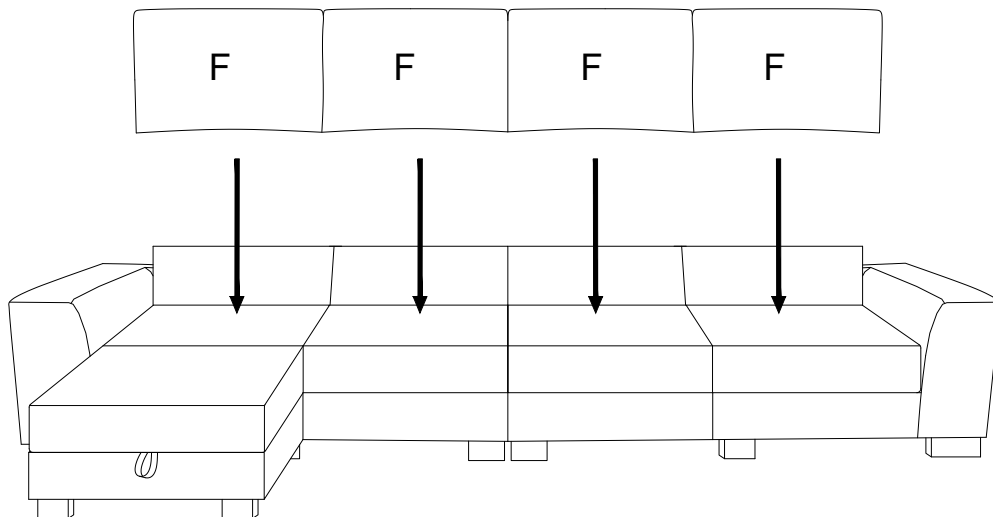
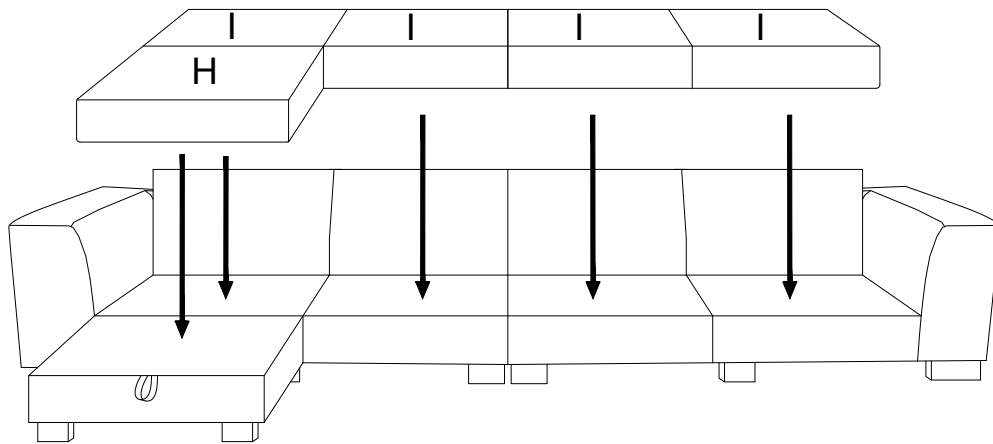

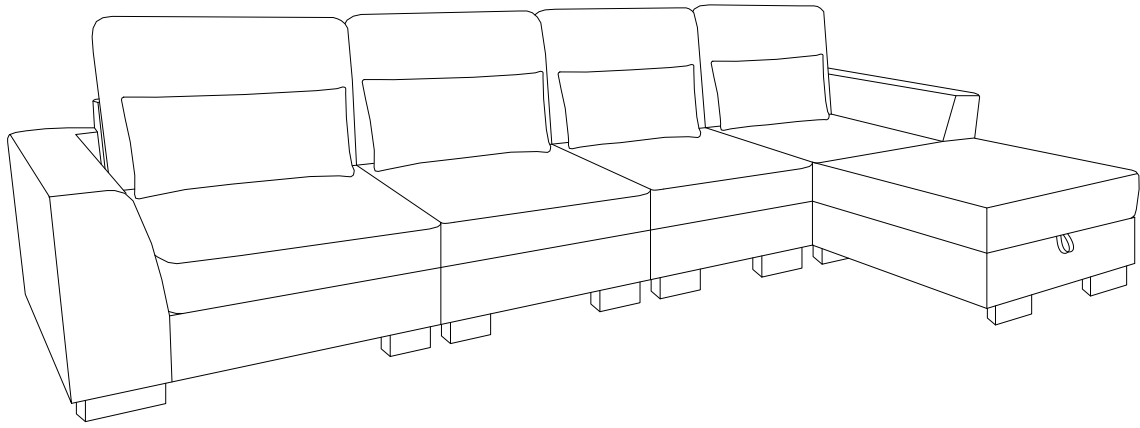

Assembly completed!

Please enjoy your sofa!