

# ASSEMBLY INSTRUCTIONS

Ax1

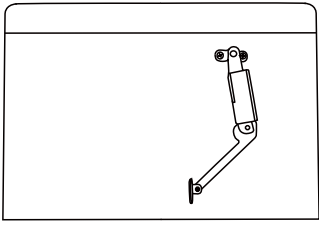

Bx1

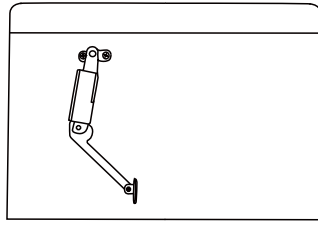

Cx1

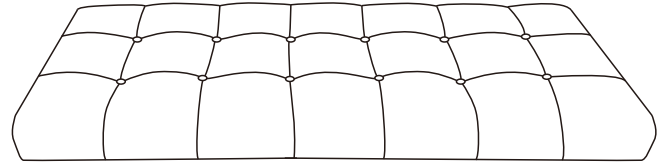

Dx1

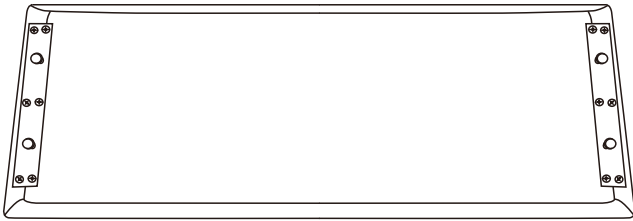

Ex1



Fx2

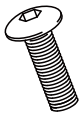

Gx14



Hx4



Ix4



Jx4



Kx1



Lx1



Mx1

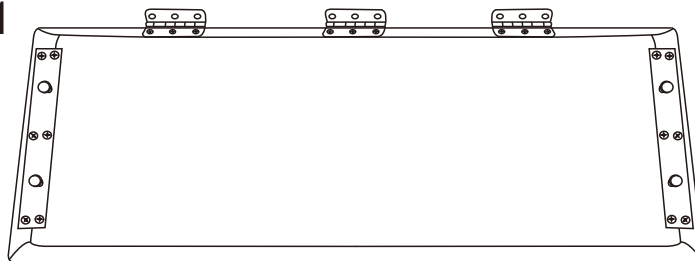

Nx9

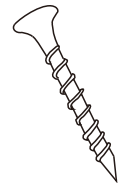

Step1: Fix C by fastening screws(N) with screwdriver(L).

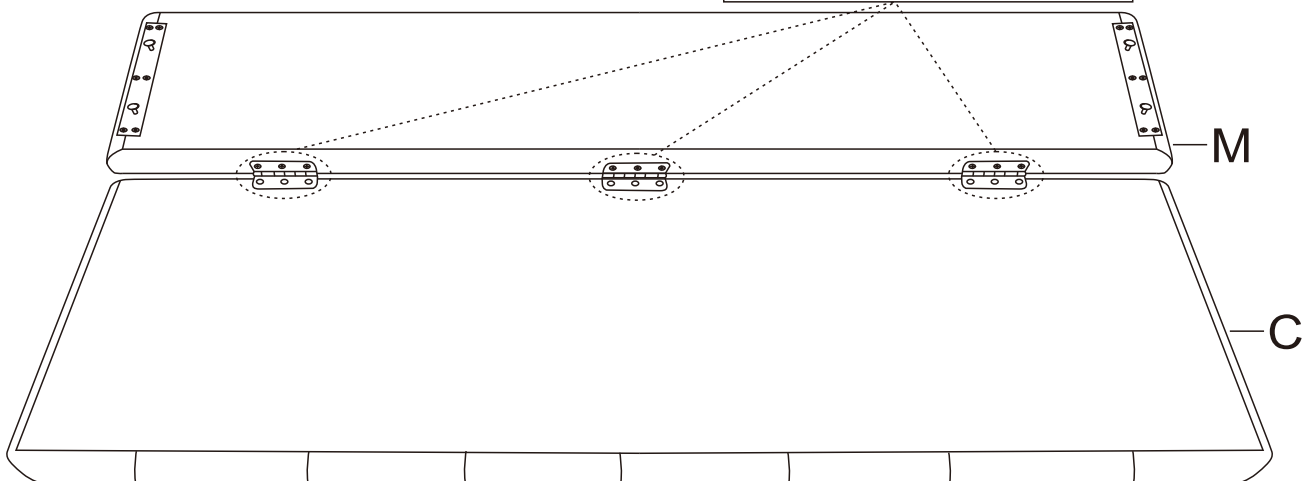
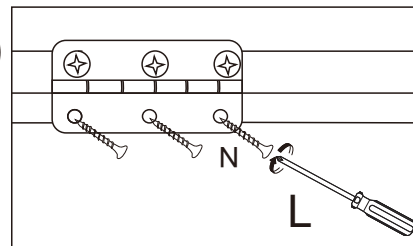

Step2: Attach A and B to M with the clips.

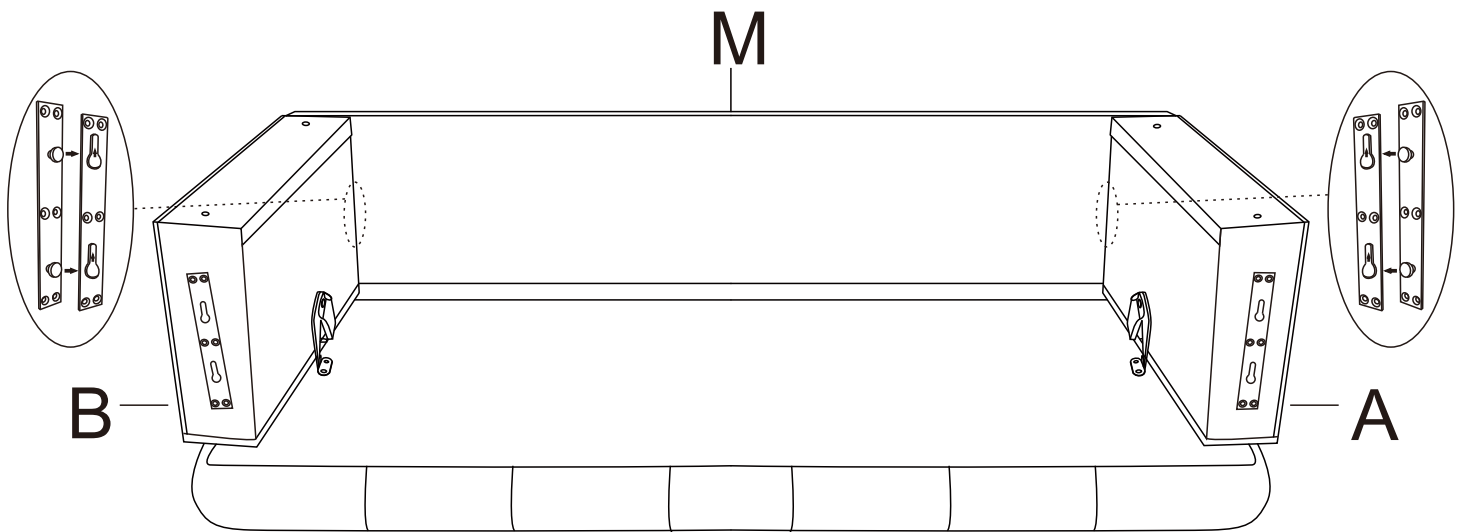

Step3: Attach D to piece from the step 2 with the clips.

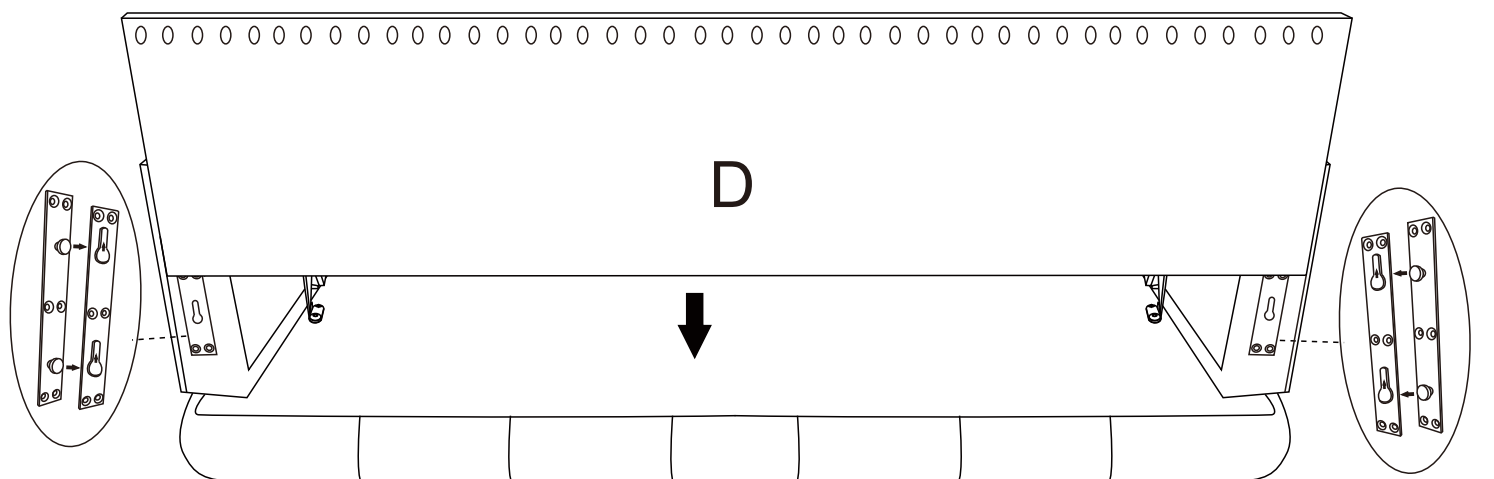

Step4: Attach E to piece from step 3 by screwing the legs(I) through washers(H). Attach the footpads(J) to the legs(I).

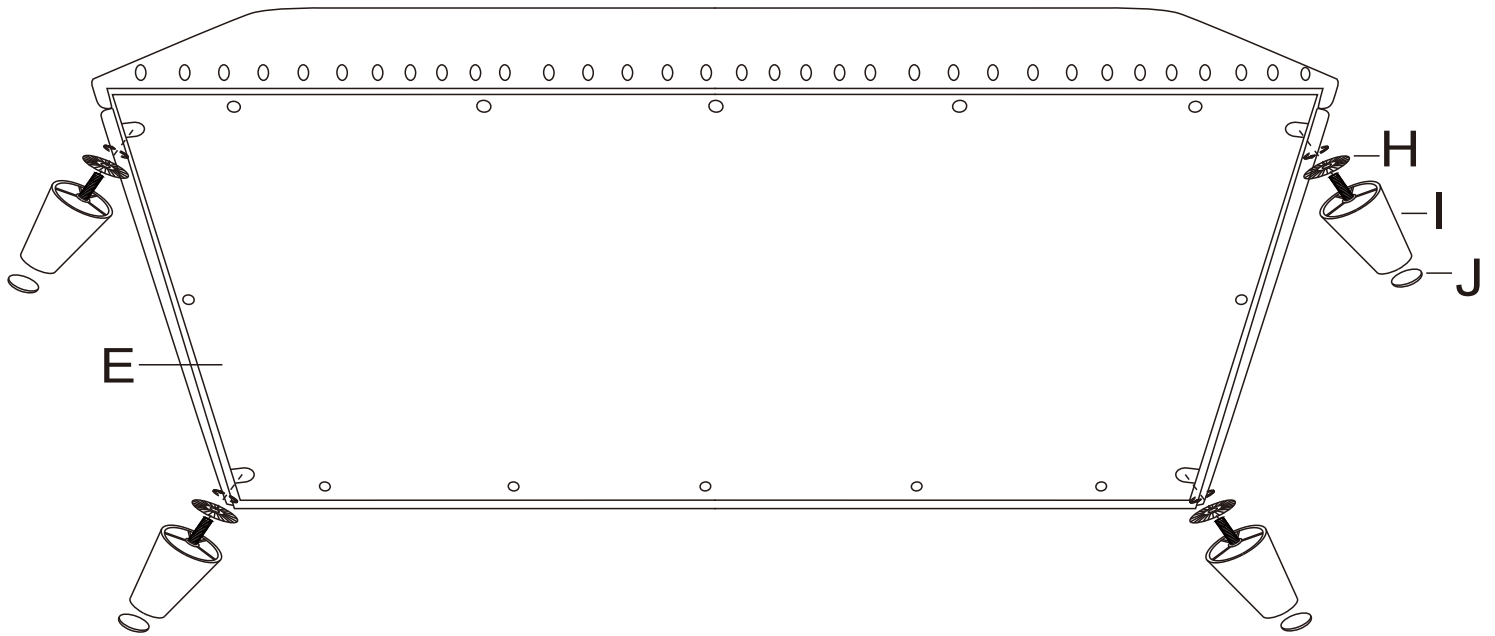

Step5: Fix E by fastening screws(G) with screwdriver(L).

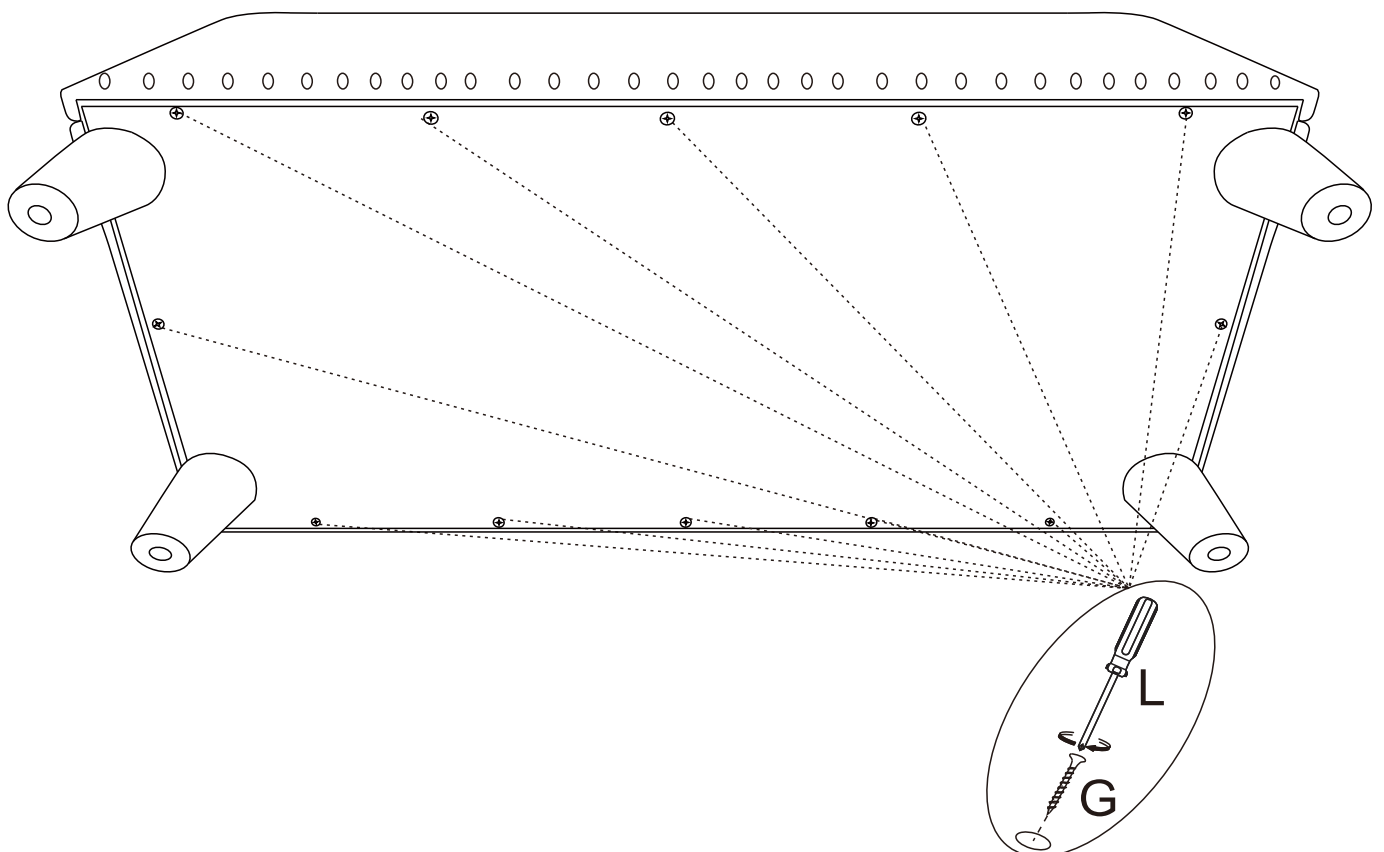

**Step6: Attach Hinge to ottoman top by fastening screws G and F with screwdriver(L) and allen key(K).**

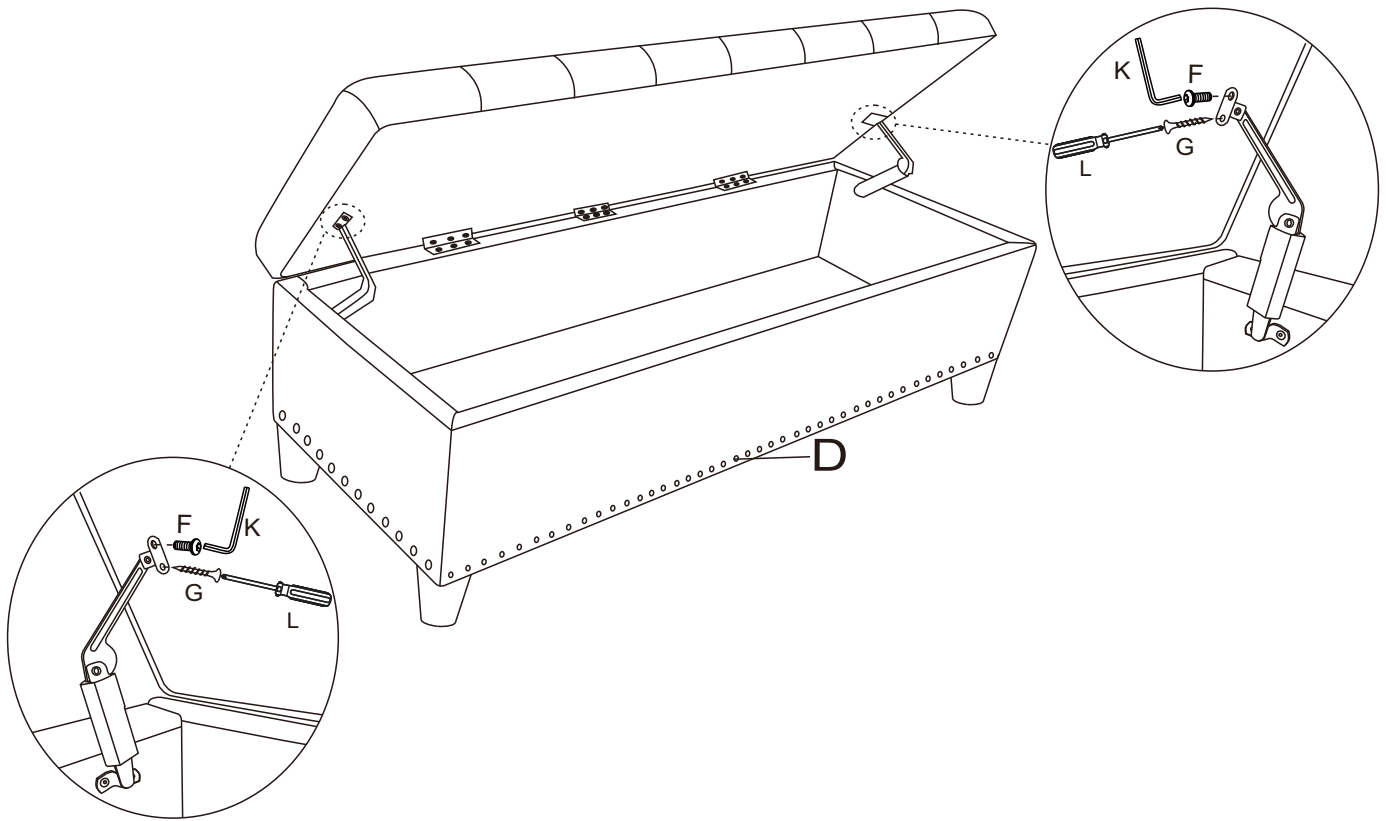

**Step7: You have done!**

