

WARNING!!

Children have died from furniture tipover. Tip restraints have been included with this product; you must install the tip restraints according to these instructions in order to minimize the risk of furniture tipping.

NEVER allow children to climb or hang on furniture, including drawers or cabinet doors.

In addition to installing the restrains, to help prevent tip-over

- 1. NEVER put a TV or other heavy objects on top of this product".**
- 2. Do not stand on the product.**

▲ WARNING	
	<p>Children have died from furniture tipover. To reduce the risk of furniture tipover:</p> <ul style="list-style-type: none">• ALWAYS install tipover restraint provided.• NEVER put a TV on this product.• NEVER allow children to stand, climb or hang on drawers, doors, or shelves.• NEVER open more than one drawer at a time.• Place heaviest items in the lowest drawers.• Do not defeat or remove the drawer interlock system.
	<p><i>This is a permanent label. Do not remove!</i></p>

Assembly Instructions

Caution : You must read this before you proceed



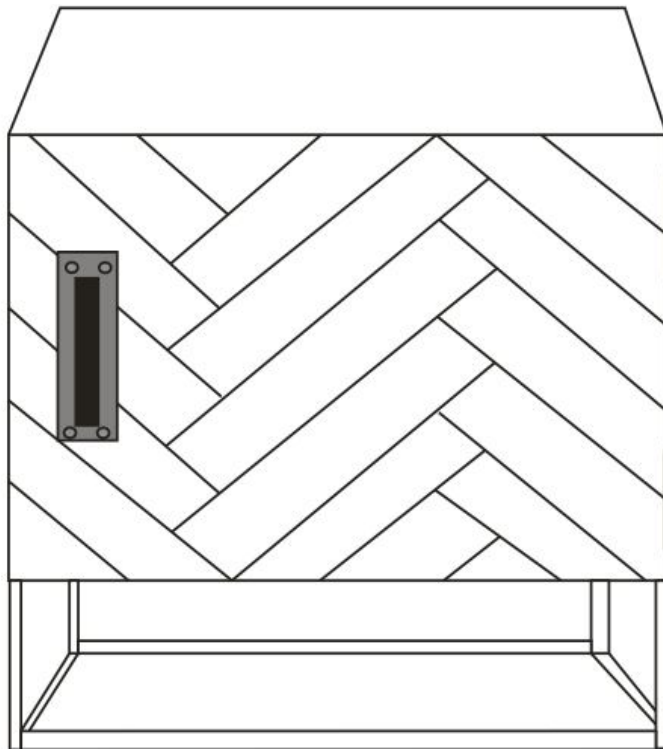

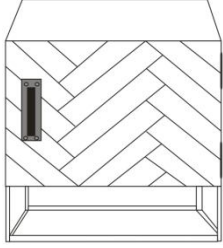

BEDSIDE

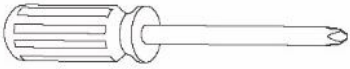
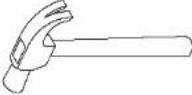

Parts List

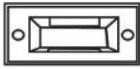
Label	Picture	Description	QTY
A		Bedside	1

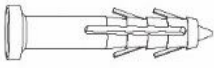
Hardware

Label	Picture	Description	QTY
①		Screwdriver (Not provided)	1
②		Hammer (Not provided)	1
③		Power Drill (Not provided)	1
④		Bracket	2
⑤		Wall Plug Screw (M8x50 mm)	4
⑥		Wall Plug (10x45 mm)	4
⑦		Tipover Restraint Straps	2

Assembly Preparation

Before
Beginning
Assembly:

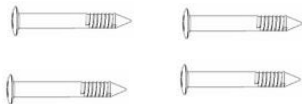
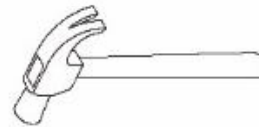
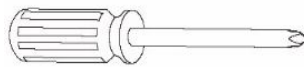
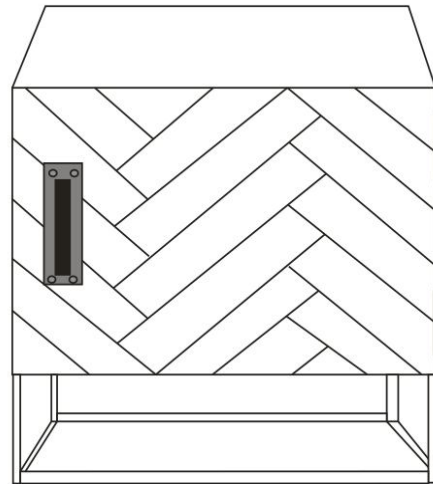
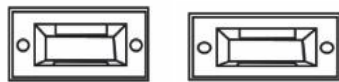

- Read instructions, cover to cover-



- Have 2 adults on hand for assembly-



- Do not assemble on flooring or carpet-



- Assemble on a clean non-marring surface (packing foam)-



- Save all packaging until finished-

Tipover Restraint Device Installation Instructions



Serious or fatal crushing injuries can occur from tipping furniture.

To help prevent tip-over: ALWAYS secure this furniture to the wall using Tipover Restraint Device.

See product instructions for more ways to help prevent furniture tip-over.

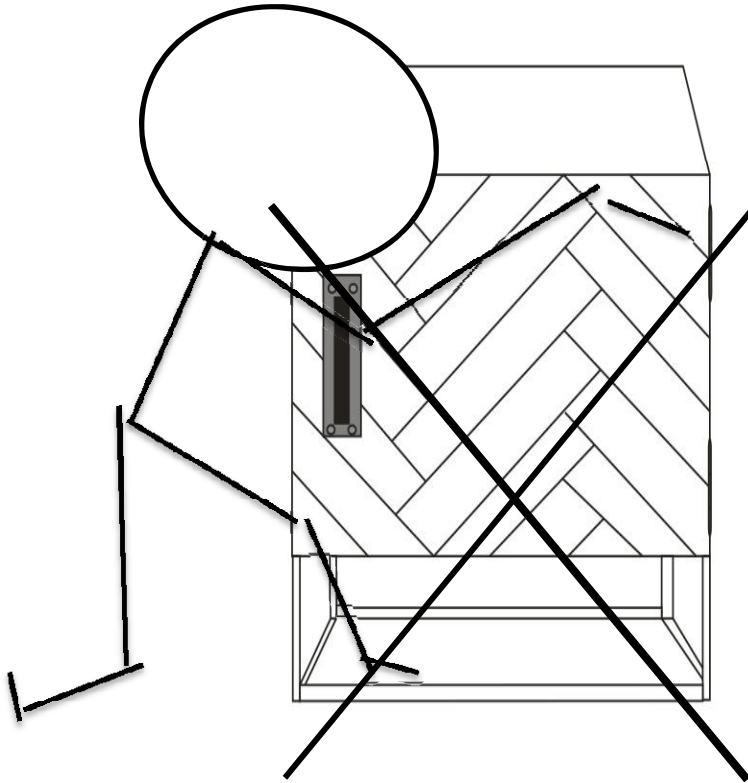

Usage For Tipover Restraint Device:

To secure Bedside against wall, attach two Brackets (④) on wall and product, use Tipover Restraint Straps (⑦) to connect the Brackets (④) .

Step 1

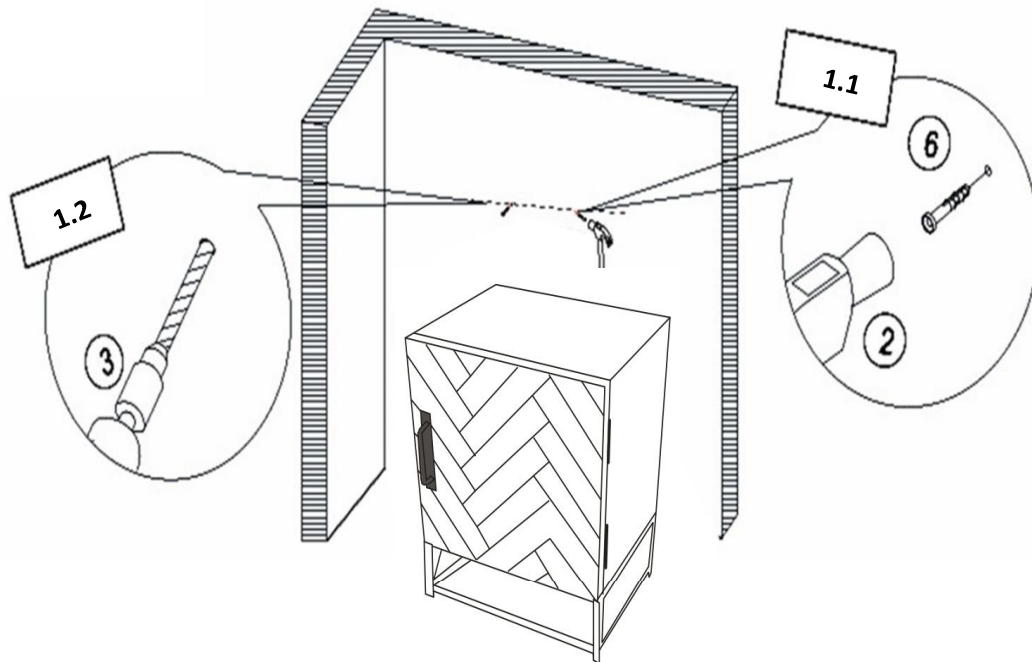

4.1) Drill two holes on wall at same height as Brackets (④) on Bedside with Power Drill (③).

You can mark these points in two ways as below:

1) Move the Bedside back to the wall. Mark two points same height as Bedside on the wall.

Note: The Brackets need to be secured to solid, load bearing surface. Please use a Stud Finder(not supplied) if needed to locate the Wall Frame.

2) Measure the height of the Brackets (④) with ruler/measuring tape and mark on wall to keep them accurate and same height.

4.2) Insert Wall Plugs (⑥) into drilled holes on wall with Hammer (②).

Step 2

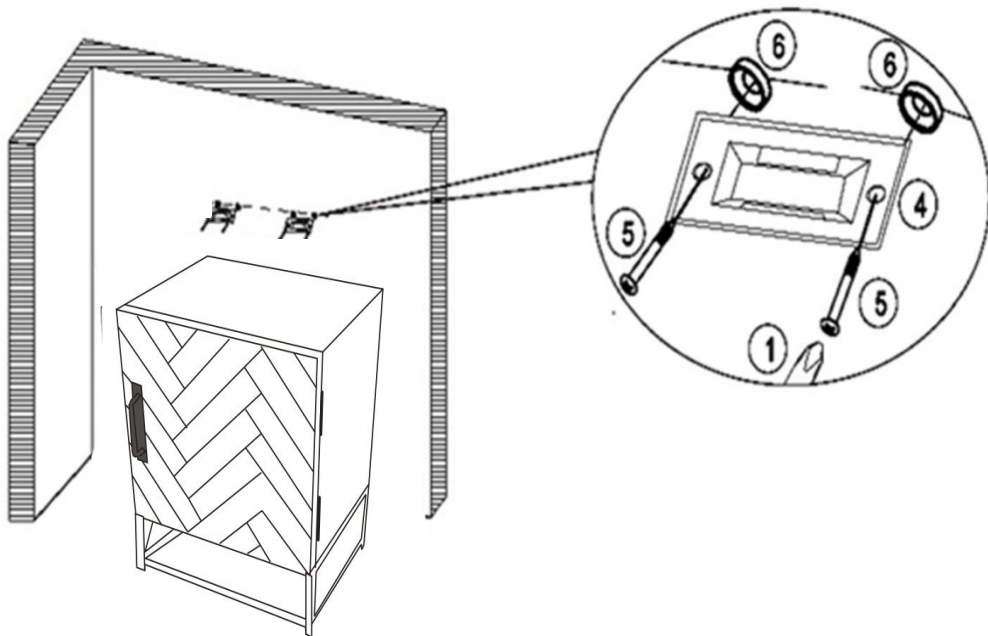

Attach Brackets (④) to Wall Plugs (⑥) using Wall Plug Screws (⑤) with Screwdriver (①).

Step 3

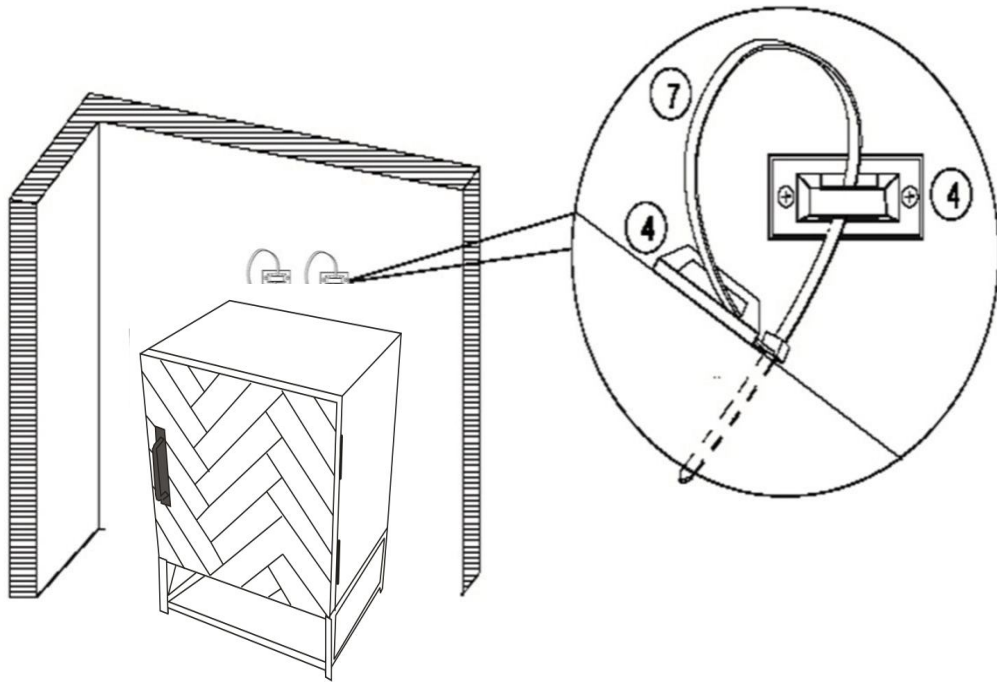











Move Bedside to the wall.

Pull the Tipover Restraint Straps (⑦) through the Brackets (④) on the wall and Bedside one by one, and pull the Tipover Restraint Straps (⑦) tight.

This Bedside is now ready to use.

Caution: This Bedside can only be used on flat, level surface.

Care & Maintenance

- ✓  • Furniture may scratch floors. We recommend using furniture pads to protect your floors.
- ⊘  • Do not put hot items directly on furniture surface
- ⊘  • Do not clean furniture with harsh cleansers or polish.
- ⊘  • Do not place furniture under direct sunlight.
- ⊘  • Do not place furniture near heating or cooling vents.
- ⊘  • Do not write on furniture without a passed banner to protect the surface.
- ⊘  • Do not place furniture outside. for indoor use only.
- ⊘  • Not for commercial use. for residential use only.
- ⊘  • Stains may be removed with mild soap solution and damp cloth.
- ⊘  • Children should not climb or jump on the furniture.
- ✓  • Dust and pick - up shills using a clean, non-colored, lint-free cloth.