

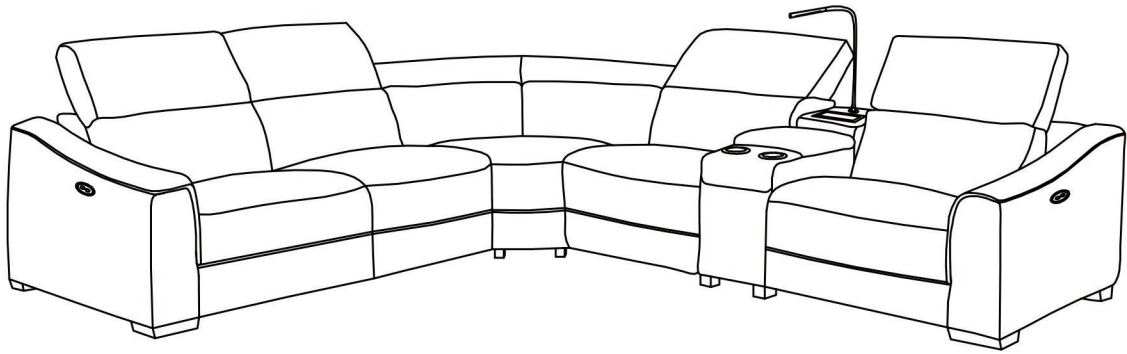





ASSEMBLY INSTRUCTION



Power packs in Console

A		Transformer(Okin)	1PC
B		Power Line	1PC
C		Y Cables	1PC

D		Extension Cord	1PC
E		Adapter(Mulin)	1PC

PLEASE NOTE: PIECES REQUIRED FOR ASSEMBLY ARE LOCATED INSIDE THE DUST COVER UNDERNEATH SOFA

BEFORE YOU START...

1. Choose a clean, level, spacious assembly area. Avoid hard surfaces that may damage the product.
2. Check and ensure that you have all required contents for complete assembly.
3. Always read the assembly instructions carefully before beginning assembly.
4. The packaging and contents can be a choking hazard, therefore keep out of reach of small children at all the times.

Step 1 Join sofa by seat connector and back connector

Step ⑤→⑥ ④→⑤ ③→④ ②→③ ①→②

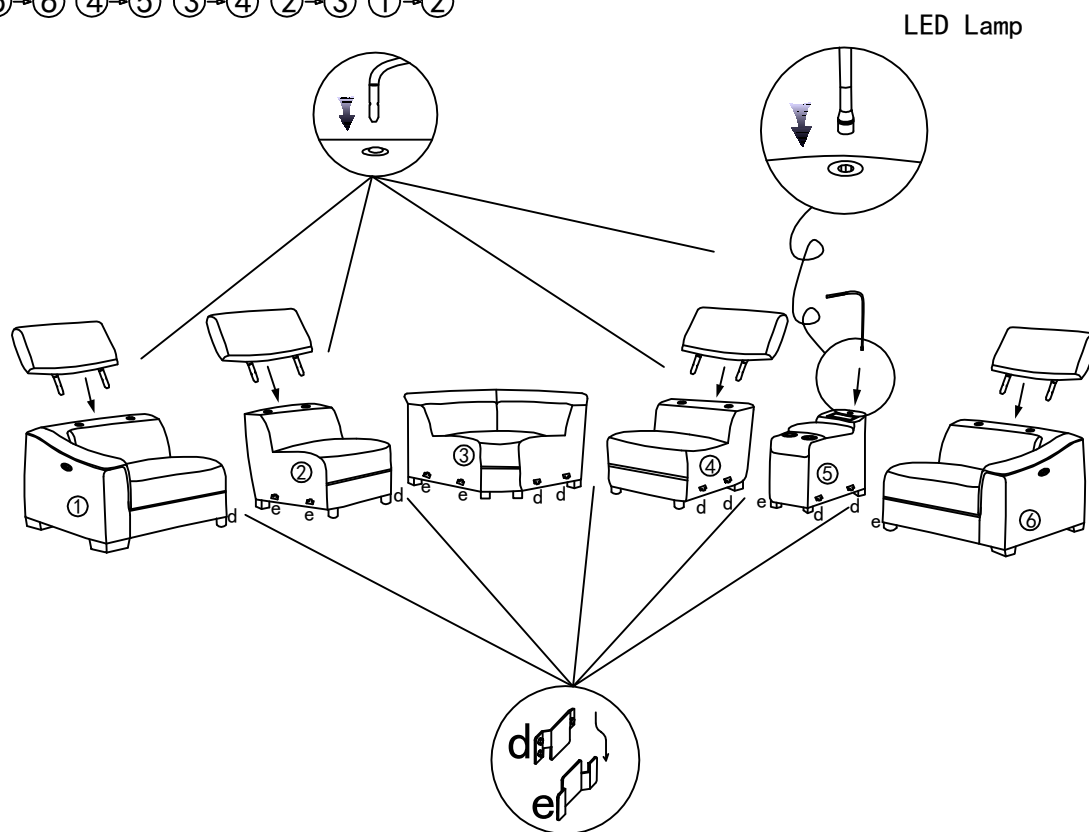

Step 2 Connect wires

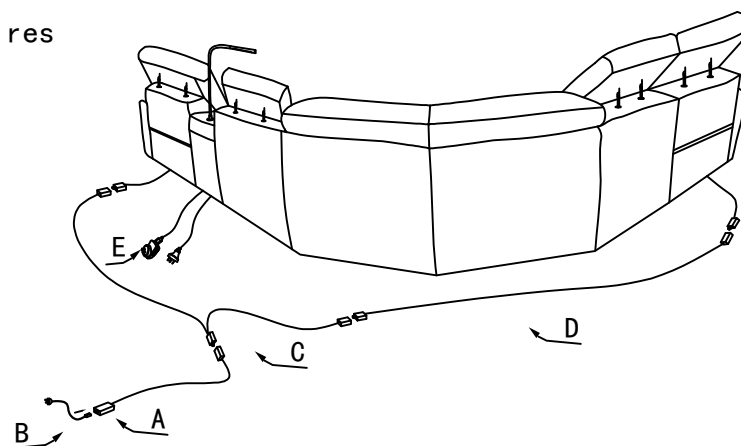

Step 3 Assembly complete

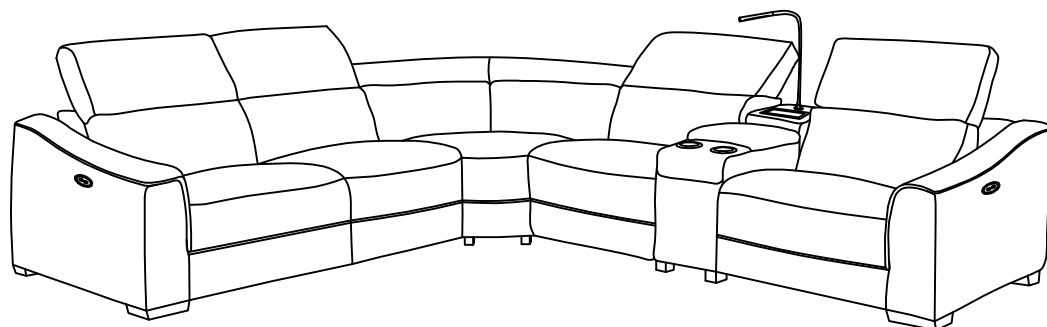

This appliance is not intended for use by persons (including children) with reduced physical, sensory or mental capabilities, or lack of experience and knowledge, unless they have been given supervision or instruction concerning the use of the appliance by a person responsible for their safety. Children should be supervised to ensure that they do not play with the appliance.